

**Traffic Alert and Collision
Avoidance System (TCAS):
A Functional Overview of Minimum TCAS II**

J.D. Welch
V.A. Orlando

8 April 1983

Lincoln Laboratory
MASSACHUSETTS INSTITUTE OF TECHNOLOGY
LEXINGTON, MASSACHUSETTS

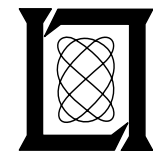

Prepared for the Federal Aviation Administration,
Washington, D.C. 20591

This document is available to the public through
the National Technical Information Service,
Springfield, VA 22161

This document is disseminated under the sponsorship of the Department of Transportation in the interest of information exchange. The United States Government assumes no liability for its contents or use thereof.

1. Report No. DOT/FAA/PM-83/10		2. Government Accession No.		3. Recipient's Catalog No.	
4. Title and Subtitle Traffic Alert and Collision Avoidance System (TCAS): A Functional Overview of Minimum TCAS II				5. Report Date 8 April 1983	
				6. Performing Organization Code	
7. Author(s) J.D. Welch and V.A. Orlando				8. Performing Organization Report No. ATC-119	
9. Performing Organization Name and Address Massachusetts Institute of Technology Lincoln Laboratory P.O. Box 73 Lexington, MA 02173				10. Work Unit No. Project No. 054-241-04	
				11. Contract or Grant No. DOT-FA72-WAI-817	
				13. Type of Report and Period Covered	
12. Sponsoring Agency Name and Address Department of Transportation Federal Aviation Administration Systems Research and Development Service Washington, D.C. 20591				14. Sponsoring Agency Code	
15. Supplementary Notes The work reported in this document was performed at Lincoln Laboratory, a center for research operated by Massachusetts Institute of Technology under Air Force Contract F19628-80-0002.					
16. Abstract The Traffic Alert and Collision Avoidance System (TCAS) is a beacon-based airborne collision avoidance system that is able to operate in all airspace without reliance on ground equipment. The TCAS concept encompasses a range of capabilities that include TCAS I, a low-cost, limited-performance version, and TCAS II, which is intended to provide a comprehensive level of separation assurance in all current and predicted airspace environments through the end of this century. This document provides a functional overview of the TCAS II including operating features, a description of the avionics package, and examples of surveillance data obtained with experimental TCAS equipment.					
17. Key Words Collision Avoidance Mode S Data Link			18. Distribution Statement Document is available to the public through the National Technical Information Service, Springfield, Virginia 22151		
19. Security Classif. (of this report) Unclassified		20. Security Classif. (of this page) Unclassified		21. No. of Pages 80	22. Price

TABLE OF CONTENTS

Introduction	1
Report Overview	4
Air Traffic Control Beacon System	6
Mode Select Beacon System	8
CAS Functions	10
TCAS II	12
TCAS II Avionics	14
TCAS II Operation	16
Details of System Operation	19
ATCRBS Synchronous Garble	20
Directional Interrogation	22
TCAS II Detection of ATCRBS-Equipped Aircraft	24
Whisper-Shout Technique	26
Improvements Due to Whisper-Shout	28
Transponder Antenna Patterns	30
Multipath	32
Multipath Suppression by Dynamic Thresholding	34
Dynamic Thresholding Data	36
TCAS II Tracking of ATCRBS-Equipped Aircraft	38
Tracking Altitude-Unknown Aircraft	40

TABLE OF CONTENTS (CONT'D)

TCAS II Acquisition of Mode S-Equipped Aircraft	42
Mode S Surveillance States	44
TCAS II Roll Call Surveillance of Mode S-Equipped Aircraft	46
Collision Avoidance Algorithms	48
TCAS Angle-of-Arrival	50
Interference-Limiting Algorithm	52
Minimum TCAS II Design Summary	54
Airborne Performance Measurements	57
The TCAS Experimental Unit (TEU)	58
TCAS Experimental Unit Characteristics	60
ATCRBS Surveillance Performance - Controlled Encounters	62
ATCRBS Surveillance Performance - Targets of Opportunity	64
Bearing Measurement Performance - Plan-Position Display for Encounter with ATCRBS Aircraft	66
Mode S Surveillance Performance	68
Bearing Measurement Performance - Plan-Position Display for Encounter with Mode S Aircraft	70
Summary	73
References	75

INTRODUCTION

TCAS Concept

In recent years the development of airborne collision avoidance systems has focused on concepts that make use of the transponders carried for ground ATC purposes and hence do not impose the need for special avionics on board the detected aircraft. Such systems have the advantage that they can provide immediate protection against collisions involving a significant and growing fraction of the aircraft population.

One system based on this technique is the Traffic Alert and Collision Avoidance System (TCAS). TCAS, like its predecessor BCAS (Beacon Collision Avoidance System [1]), is designed to provide protection against aircraft equipped with both the current (ATCRBS) and future (Mode S) air traffic control transponders.

TCAS encompasses a range of capabilities including (a) TCAS I, a low-cost, limited-performance version, and (b) TCAS II, which is intended to provide a comprehensive level of separation assurance in all current and predicted airspace environments through the end of this century.

TCAS II

Without reliance on ground equipment, TCAS II is capable of providing resolution advisories in the vertical dimension (climb, descend) in airspace densities up to 0.3 aircraft per square nautical mile (or approximately 24 aircraft within 5 nautical miles of the TCAS II aircraft). Traffic advisories on nearby aircraft may also be provided. These include the clock position, or bearing, of the intruding aircraft. The TCAS II uses the Mode S data link to transmit advisories to nearby TCAS I aircraft. These crosslinked advisories provide the position of the TCAS II aircraft as seen from the TCAS I aircraft. The Mode S air-to-air data link is also used to coordinate escape maneuvers among TCAS II aircraft that are in conflict.

It is important to ensure that the secondary surveillance radar signals transmitted by TCAS II avionics do not degrade the ability of ground-based ATC radars to sense traffic. TCAS II includes interference limiting algorithms that are designed to ensure that the ability of ground secondary surveillance radars to receive replies in response to interrogations is not reduced by more than 2 percent as a result of TCAS II operation.

A more capable system, called enhanced TCAS II, uses more accurate intruder bearing data to allow it to reduce unnecessary alarms (by estimating the horizontal miss distance) and to generate horizontal resolution advisories (turn right, turn left).

TCAS I

TCAS I [2] has the ability to receive and display the traffic advisories crosslinked by TCAS II. It also has the ability to sense the presence and display traffic advisories on nearby aircraft by detecting their transponder transmissions (replies) at 1090 MHz. The replies detected may have been elicited by ground station interrogations or by spontaneous transmissions of Mode S transponders (passive TCAS I) or may have resulted from low power interrogations from TCAS I (active TCAS I [3]). Enhancements of TCAS I can take many forms. In particular, on-board direction-finding antennas could be used to augment the range and altitude information obtained from transponder replies.

REPORT OVERVIEW

This report presents a functional overview of the minimum TCAS II system. It begins with a description of the ATRBS and Mode S systems that form the basis for TCAS. This is followed by a review of the functions performed by any collision avoidance system and then a definition of the way in which these functions are implemented in the minimum TCAS II.

Next, details of system operation are presented for each of the major subsystems along with appropriate experimental data to illustrate particular techniques. This section concludes with a summary of TCAS II design parameters.

This is followed by examples of representative airborne performance measurements that describe measured performance in an operational environment.

The report concludes with a summary of the key points.

REPORT OVERVIEW

SYSTEM DESCRIPTION

- BEACON SYSTEM DEFINITION
- CAS REQUIREMENTS
- TCAS II CONCEPT

• DETAILS OF SYSTEM OPERATION

- ATCRBS SURVEILLANCE
- MODE S SURVEILLANCE
- CAS ALGORITHM
- BEARING ESTIMATION
- INTERFERENCE LIMITING
- TCAS II DESIGN SUMMARY

• AIRBORNE PERFORMANCE MEASUREMENTS

• SUMMARY

AIR TRAFFIC CONTROL BEACON SYSTEM

The operation of the current Air Traffic Control Radar Beacon System (ATCRBS) is illustrated schematically in the figure. ATCRBS uses simple two-pulse interrogations transmitted from a rotating antenna. Two types of interrogations are used for civil transponders: Mode A which elicits one of 4096 identity codes; and Mode C which elicits a similar 12-bit code containing the aircraft's barometric altitude, referenced to standard atmospheric conditions.

Since all equipped aircraft in the antenna mainbeam respond to each ATCRBS interrogation, replies from aircraft with nearly identical ranges will overlap each other at the interrogator receiver. This phenomenon is called synchronous garble. It is controlled in the ground system by using a narrow antenna beam and by restricting each sensor to the absolute minimum range required for air traffic control purposes.

At short ranges, the signal strength may be sufficient to interrogate transponders via leakage through the antenna sidelobes. To control this phenomenon, aircraft in the antenna sidelobes are prevented from replying by a technique known as transmit sidelobe suppression. The P2 pulse of the interrogation is transmitted on an omni-directional antenna at a slightly higher power level than the interrogator power produced by the antenna sidelobes. Transponders are designed to reply only if the received P1 pulse is greater than the received P2 pulse. This condition is not satisfied in the sidelobes of the antenna.

AIR TRAFFIC CONTROL RADAR BEACON SYSTEM (ATCRBS)

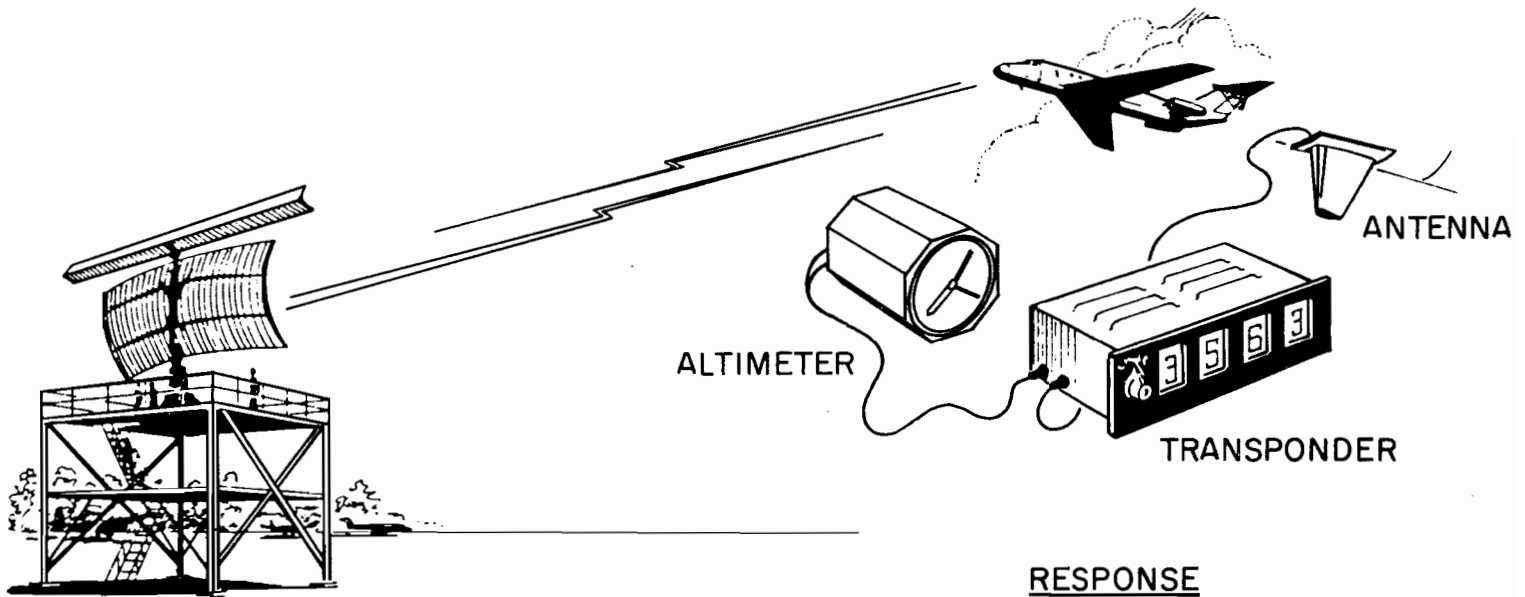

INTERROGATION

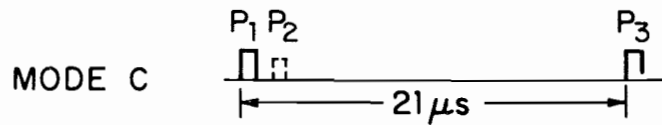
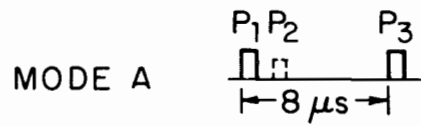

RESPONSE

IDENTIFICATION CODE

3563

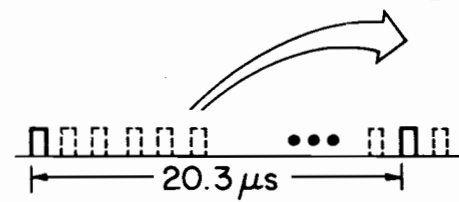

ALTITUDE

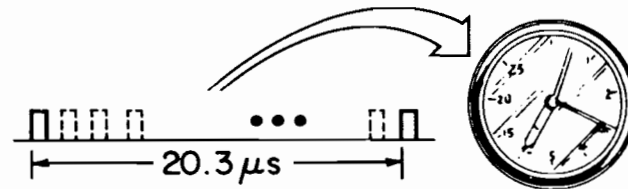

MODE SELECT BEACON SYSTEM

The Mode S beacon system [4] was developed as an evolutionary improvement to the ATCRBS system to enhance air traffic control surveillance reliability and to provide a ground-air-ground digital data communication capability. Each aircraft is assigned a unique address code which permits data link messages to be transferred along with surveillance interrogations and replies.

Like ATCRBS, Mode S will locate an aircraft in range and azimuth, report its altitude and identity, and provide the general surveillance service currently available. However, because of its ability to selectively interrogate only those aircraft within its area of responsibility, Mode S can avoid the interference which results when replies are generated by all the transponders within the beam. If Mode S schedules its interrogations appropriately, responses from aircraft will not overlap each other at the receiver.

The Mode S signal formats are illustrated in the figure. Mode S uses the same frequencies as ATCRBS for interrogations and replies (1030 and 1090 MHz, respectively). The Mode S interrogation consists of a two-pulse preamble plus a string of 56 or 112 data bits (including the 24-bit address) transmitted using binary differential phase shift keying (DPSK) at a 4 Mbps rate. The preamble pulses are 0.8 microseconds wide and are spaced 2.0 microseconds apart. An ATCRBS transponder that receives the interrogation interprets this pulse pair as an ATCRBS sidelobe suppression, causing it to be suppressed for the remainder of the Mode S interrogation. Without such suppression, the following Mode S data block would, with high probability, trigger ATCRBS transponders and cause spurious replies.

The reply also comprises 56 or 112 bits including address, and is transmitted at 1 Mbps using binary pulse-position modulation (PPM). The four-pulse reply preamble is designed to be easily distinguished from an ATCRBS reply sequence. It can be reliably recognized and used as a source of reply timing even in the presence of an overlapping ATCRBS reply, while at the same time achieving a low rate of false alarms arising from multiple ATCRBS replies.

The Mode S parity coding scheme is designed so that an error occurring anywhere in an interrogation or a reply will modify the decoded address. If there is an error on the uplink, the transponder will not accept the message and will not reply, since the interrogation does not appear to be addressed to it. If there is an error on the downlink, the interrogator will recognize that an error has occurred, since the reply does not contain the expected address. This error detection feature along with the ability to reinterrogate a particular aircraft if a reply is not correctly received gives Mode S the required high surveillance and communications reliability.

MODE S INTERROGATION AND REPLY WAVEFORMS

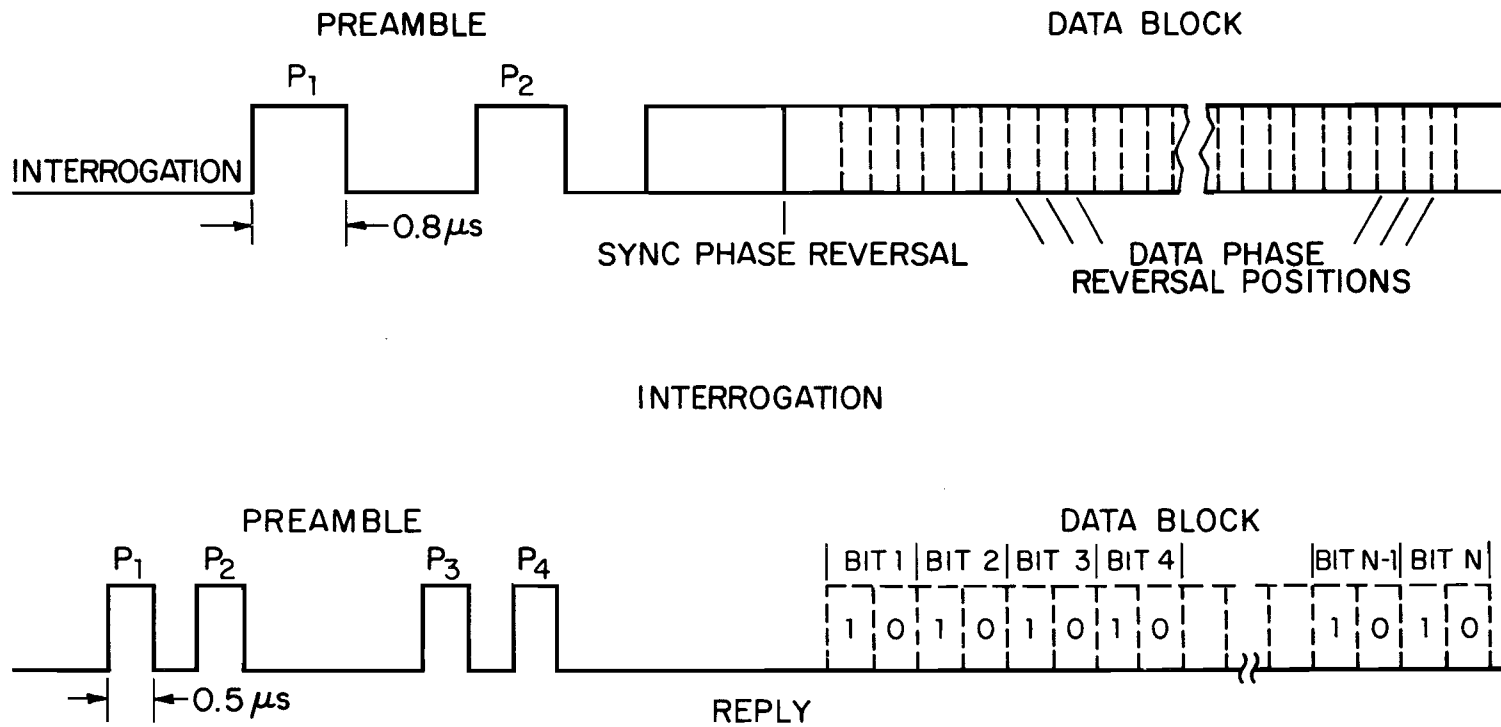

ATC-119-3

CAS FUNCTIONS

The main function of an airborne collision avoidance system such as TCAS II is to locate all nearby aircraft that could become collision threats.

In addition to surveillance, there is control logic to decide which way to maneuver, and there is a display for advising the pilots of that decision. Another requirement of all CAS systems is a means of coordination. If the conflicting aircraft is also CAS equipped, it will almost surely execute its own escape maneuver. When this happens, the two maneuvers must be coordinated.

CAS FUNCTIONS

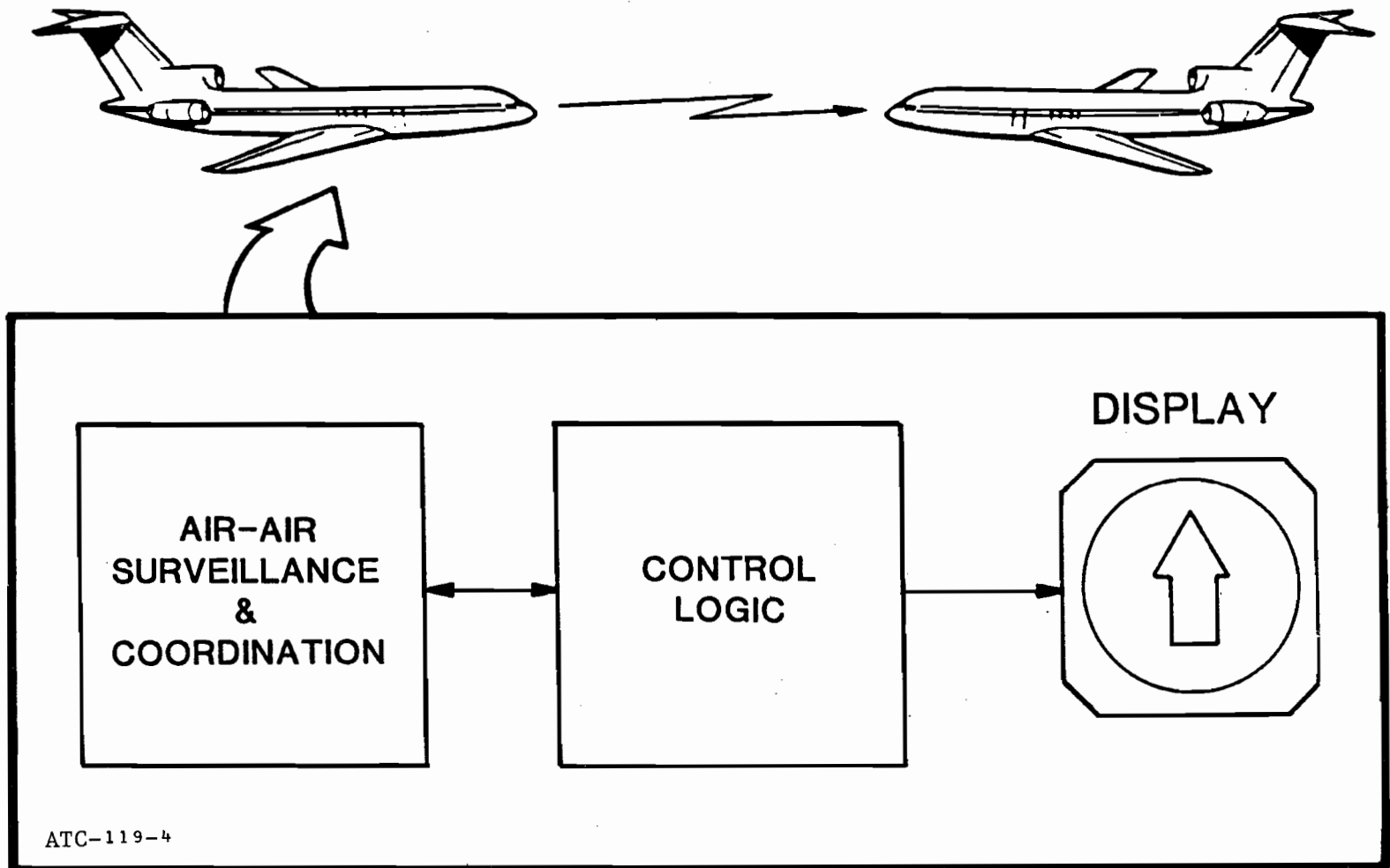

TCAS II

TCAS II alternates between Mode S and ATRBS surveillance modes. In its simplest form the TCAS II surveillance data consist of range and altitude information plus a bearing estimate accurate to a clock position. Threat detection and resolution logic provides pilot maneuver advisories in the vertical dimension. These include CLIMB, DESCEND, DON'T CLIMB, DON'T DESCEND and LIMIT VERTICAL RATE advisories.

The availability of the Mode S data link allows TCAS II to interact differently with the three classes of detectable aircraft, depending on how the aircraft is equipped.

If the detected aircraft is TCAS II equipped, the Mode S data link is used to prevent ties in the selection of an escape maneuver, thereby ensuring that both aircraft maneuver in a complementary way to give the greatest separation for a given threat warning time.

If the detected aircraft is equipped with a Mode S transponder, the Mode S data link provides knowledge of the speed capability of the detected aircraft and allows the TCAS II-equipped aircraft to transmit a crosslink alert to indicate that the detected aircraft is in conflict with the TCAS II aircraft. If the Mode S aircraft is also equipped with TCAS I, TCAS II can transmit a traffic advisory that provides the range, altitude, and bearing of TCAS II as seen by TCAS I. The purpose of this crosslink traffic advisory is to enhance visual acquisition of the TCAS II aircraft by the TCAS I pilot.

The operation of TCAS II does not require ground equipment. However, when in coverage of a Mode S ground sensor, provision is made for the Mode S transponder on board the TCAS II aircraft to accept commands that control the sensitivity level of the collision avoidance logic and to downlink displayed resolution advisories for possible coordination with ground ATC operations.

TCAS II SYSTEM DESCRIPTION

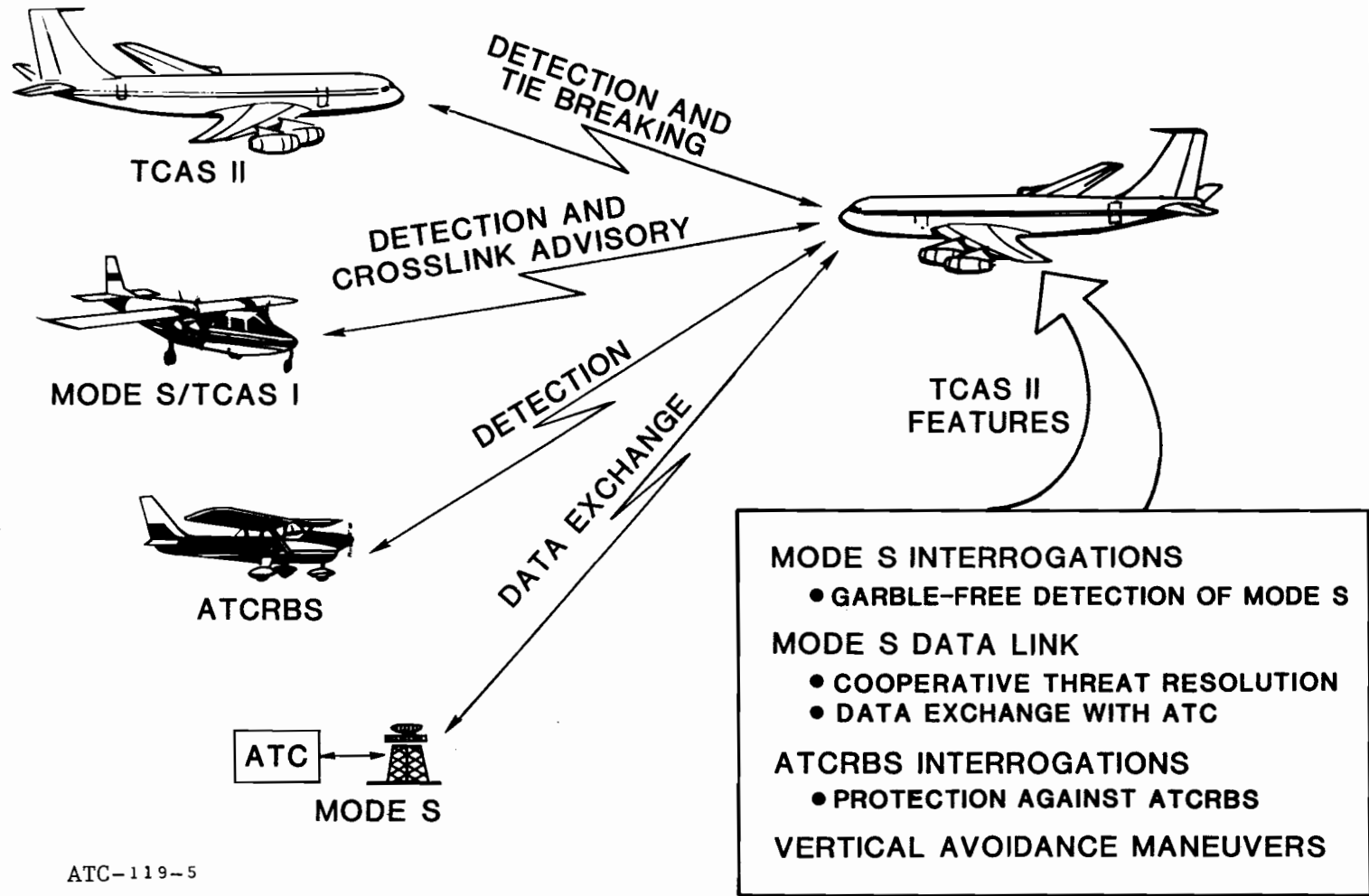

ATC-119-5

TCAS II AVIONICS

The TCAS II avionics package has the capability of detecting nearby aircraft, evaluating their threat potential, and then resolving declared conflicts. Specific functions required to do this are shown in the figure.

- Dual Antenna Installation - The TCAS II unit and the Mode S transponder both employ top- and bottom-mounted antennas. The top-mounted TCAS II antenna is capable of directional transmission and reply bearing measurement.
- Mode S Transponder - This transponder supports ATC surveillance and coordination with other TCAS II aircraft and ground ATC.
- ATCRBS Surveillance - Active transmission of special Mode C interrogations elicits replies from ATCRBS transponders and tracks them to develop range and altitude rates.
- Mode S Surveillance - Mode S aircraft are acquired passively through spontaneous (squitter) transmissions emitted periodically by all Mode S transponders. Potentially threatening aircraft are discretely interrogated to develop a track in range and altitude.
- Mode S Data Link - This link is used for tie prevention and the transmission of crosslink traffic advisories. Other uses include transmission of aircraft speed capability for use in reducing the interrogation rate for distant (non-threatening) aircraft.
- Collision Avoidance Algorithms - Surveillance and data link information developed as described above is evaluated by the collision avoidance algorithms to determine the presence of potential collision threats. Declared threats are resolved by means of altitude maneuver advisories presented to the pilot on the TCAS II display. This process is performed cooperatively between TCAS II aircraft.
- Cockpit Display - A common display may be used for TCAS II and Mode S data link applications. Display may include target parameters such as range, altitude, and bearing.

MINIMUM TCAS II ELEMENTS



TCAS II
ON BOARD
AVIONICS

SENSITIVITY LEVEL CONTROLLED

- AUTOMATICALLY
BASED ON FLIGHT
REGIME
- MANUALLY
- BY MODE S
ON GROUND

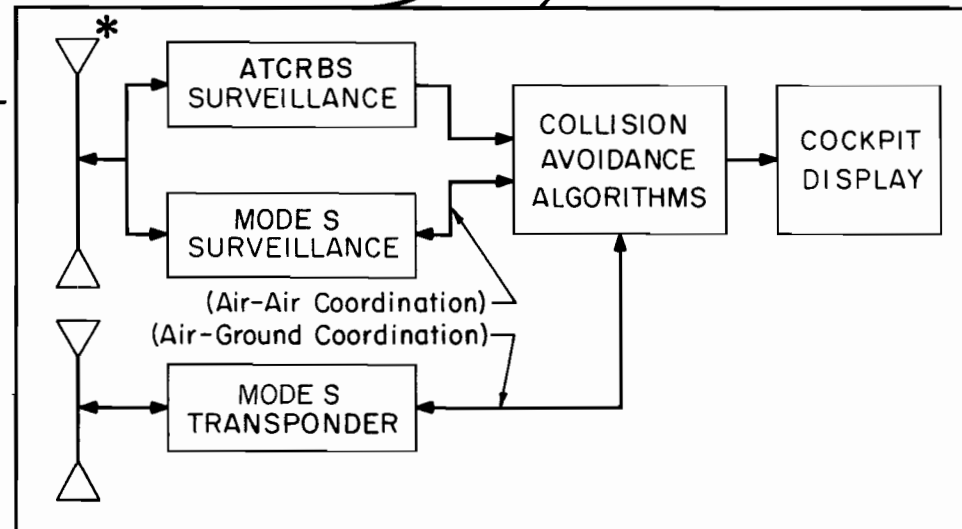

TCAS ADVISORIES

- DESCEND
- CLIMB
- DON'T DESCEND
- DON'T CLIMB
- LIMIT VERTICAL
RATE

ATC-119-6

* TOP-MOUNTED TCAS II ANTENNA IS CAPABLE OF DIRECTIONAL TRANSMIT AND BEARING MEASUREMENT ON RECEIVE. ALL OTHER ANTENNAS ARE OMNI-DIRECTIONAL.

TCAS II OPERATION

In operation, TCAS II alternates between Mode S discrete addressed and special Mode C interrogations to provide intruder position updates to the collision avoidance algorithms. At any moment, the TCAS II performs surveillance on aircraft in several conflict categories; from simple detection of non-conflicting aircraft to full range/altitude tracking for potentially threatening aircraft.

In the event of a detected threat, the sequence of events is conditioned by the type of equipment on board the threat. A typical sequence of events for a TCAS II/TCAS I encounter is presented in the figure.

EXAMPLE OF TCAS II-TCAS I ENCOUNTER

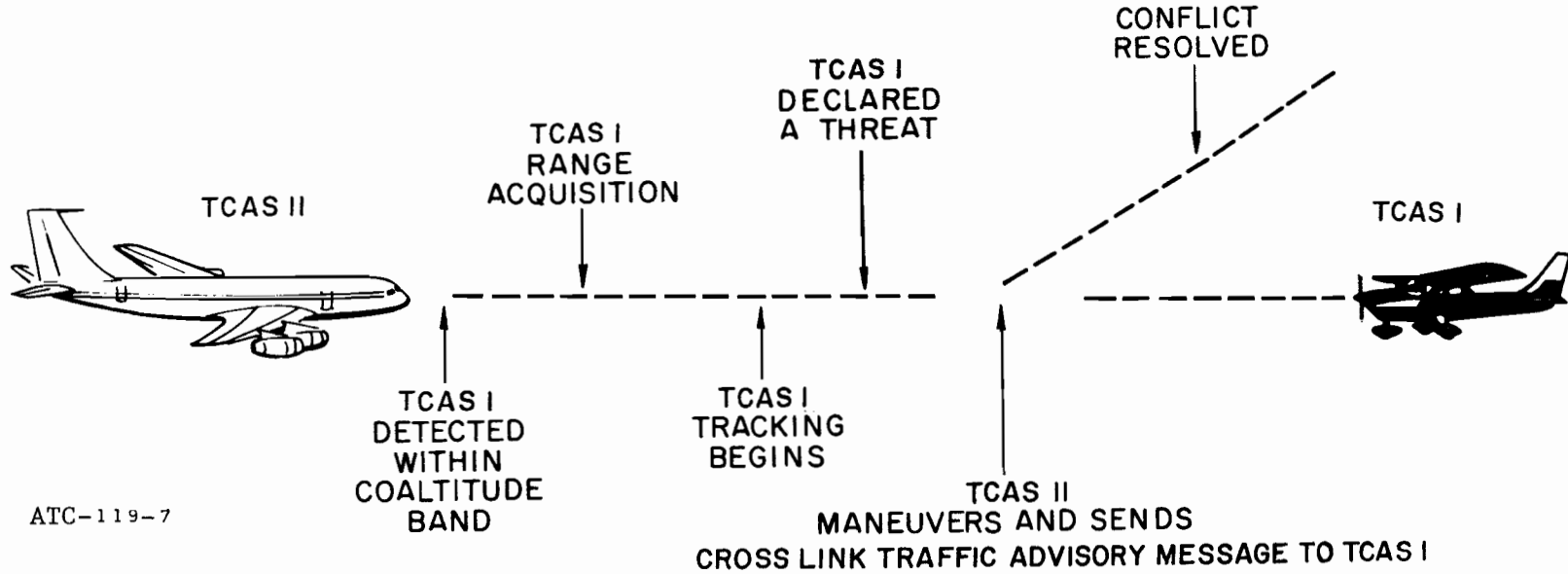

DETAILS OF SYSTEM OPERATION

ATCRBS SYNCHRONOUS GARBLE

When an ATCRBS interrogation is transmitted, all the transponders that detect it reply. Since the reply is 21 microseconds long, all aircraft whose ranges are within about 3 miles of each other generate replies that persistently and synchronously overlap each other back at the interrogating aircraft. If the transmission is omnidirectional and if aircraft are distributed roughly uniformly in area, the number of overlapping replies is proportional to the density of aircraft and the range. Ten overlapping replies is typical in terminal areas along the East coast. It is possible to reliably decode only about 3 overlapping replies. So there is a clear need to reduce the number of transponders that reply to each interrogation.

ATCRBS SYNCHRONOUS GARBLE

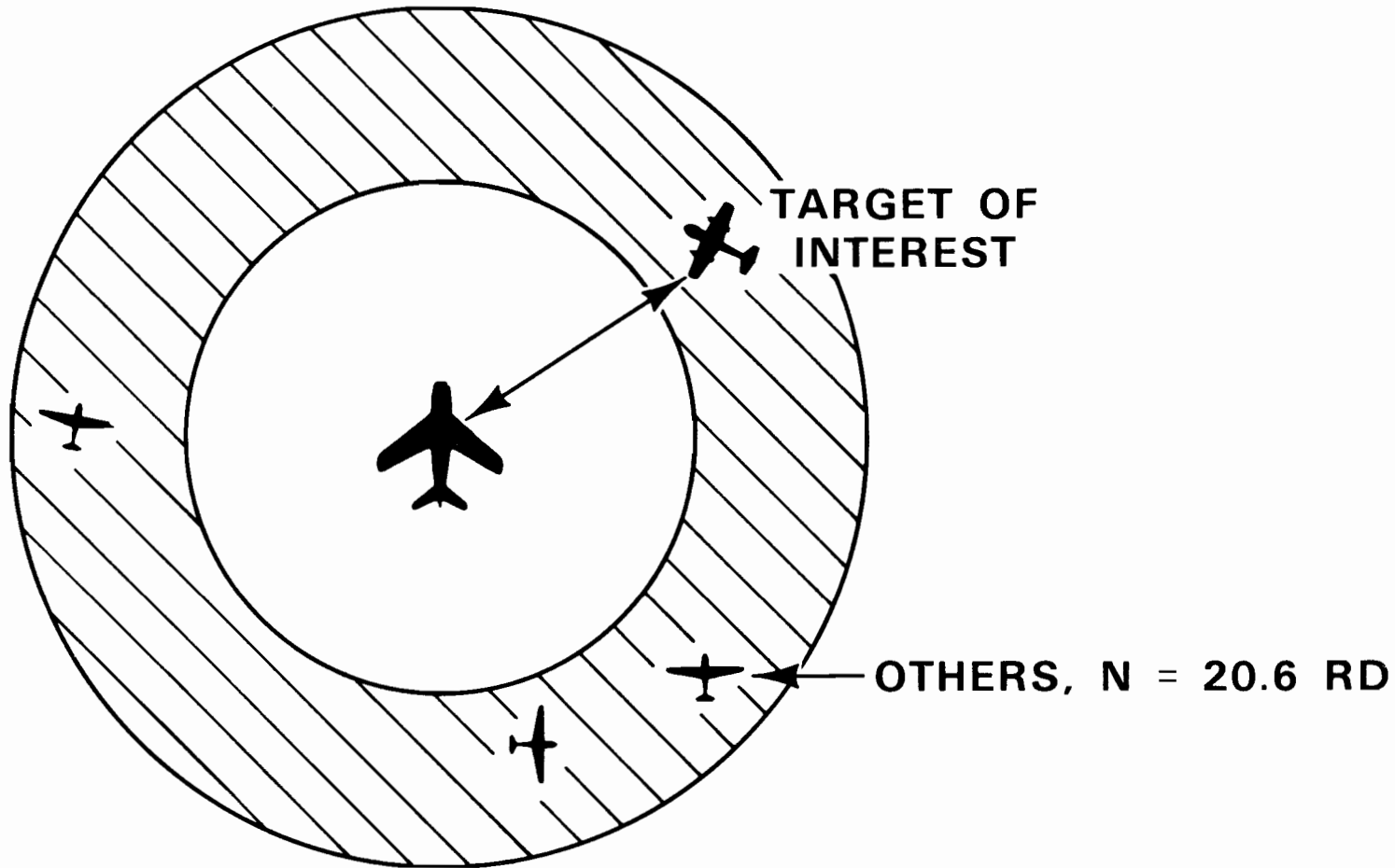

EXAMPLE

IF $R = 10$ nmi, $D = 0.05$ AIRCRAFT/nmi²
THEN $N = 11$ AIRCRAFT

DIRECTIONAL INTERROGATION

The use of a directional interrogation is one technique for reducing ATCRBS synchronous garble in the highest density environments. The directional interrogation only elicits replies from the cross-hatched region shown on the figure. This reduces the size of the reply region and hence the number of aircraft that reply to any interrogation.

Coverage must be provided in all directions, hence multiple beams are used to elicit replies from all aircraft in the vicinity of the TCAS II aircraft. Care must be taken to overlap the beams so that gaps in coverage do not exist at the beam edge.

DIRECTIONAL INTERROGATION

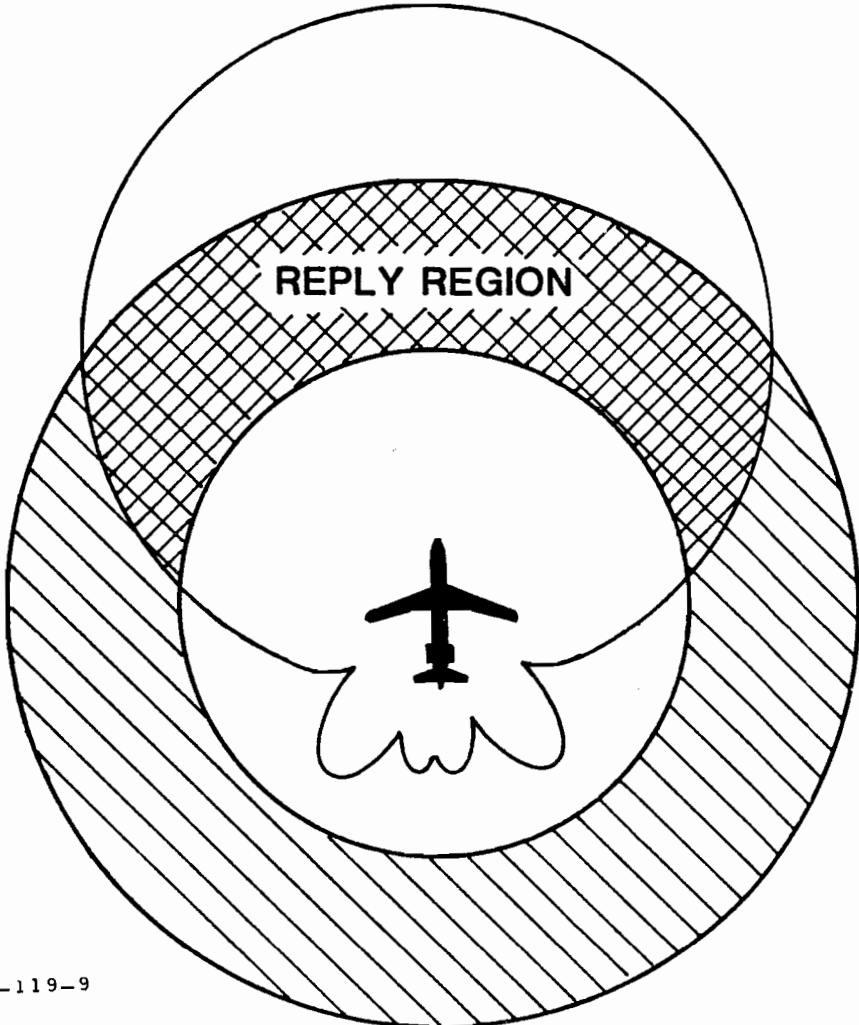

ATC-119-9

TCAS II DETECTION OF ATCRBS-EQUIPPED AIRCRAFT

A second technique for controlling ATCRBS synchronous garble is to prevent Mode S transponders from replying to the TCAS ATCRBS interrogations. This is achieved by transmitting the Mode C-only All-Call, a modified Mode C interrogation with an 0.8-microsecond wide P_4 pulse following the P_3 pulse by 2 microseconds. Mode S transponders are designed to ignore such interrogations. In this way, as aircraft become Mode S-equipped, they are removed from the ATCRBS population and do not contribute to the ATCRBS synchronous garble environment.

EXAMPLE OF ATCRBS DETECTION BY TCAS II

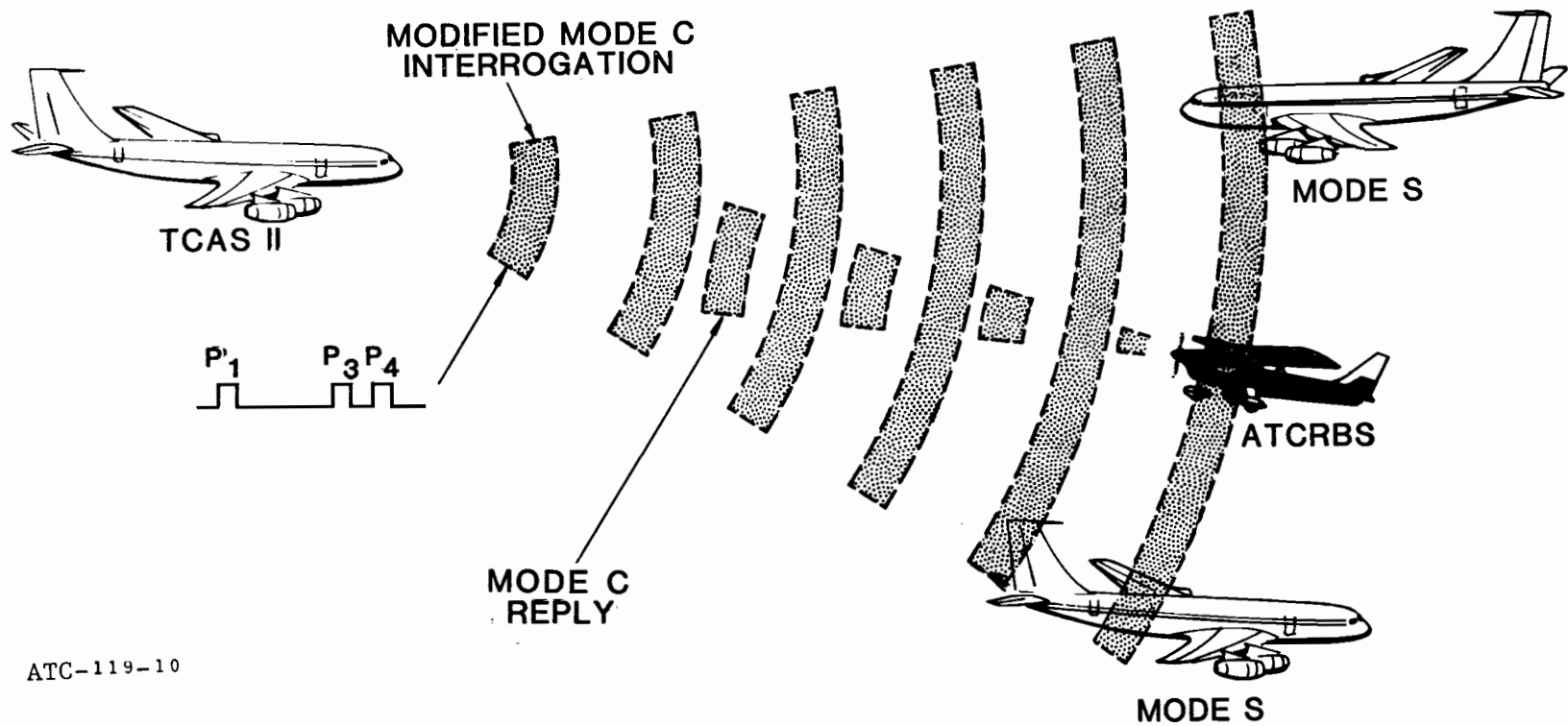

ATC-119-10

WHISPER-SHOUT TECHNIQUE

The principal technique for controlling synchronous garble is through the use of variable power levels for ATCRBS interrogations and suppressions [5].

Assume that there is a group of transponders at some range and that all of their sensitivities are known. The power level of the first interrogation could then be selected so that exactly half of the targets receive the signal above their receiver threshold and half don't detect the interrogation at all. After the replies to this interrogation have been received at the TCAS unit, a suppression is transmitted at the same power level as the previous interrogation to shut off all of the transponders that replied to the previous interrogation. This suppression is immediately followed by a full-power interrogation which elicits replies from the transponders that failed to reply to the first interrogation. In this way the transponder population is divided into two parts. In the minimum TCAS II design, this sequence is repeated with up to 24 separate power levels, and the first pulse of the interrogation serves as the second pulse of the suppression, as shown.

WHISPER-SHOUT TECHNIQUE

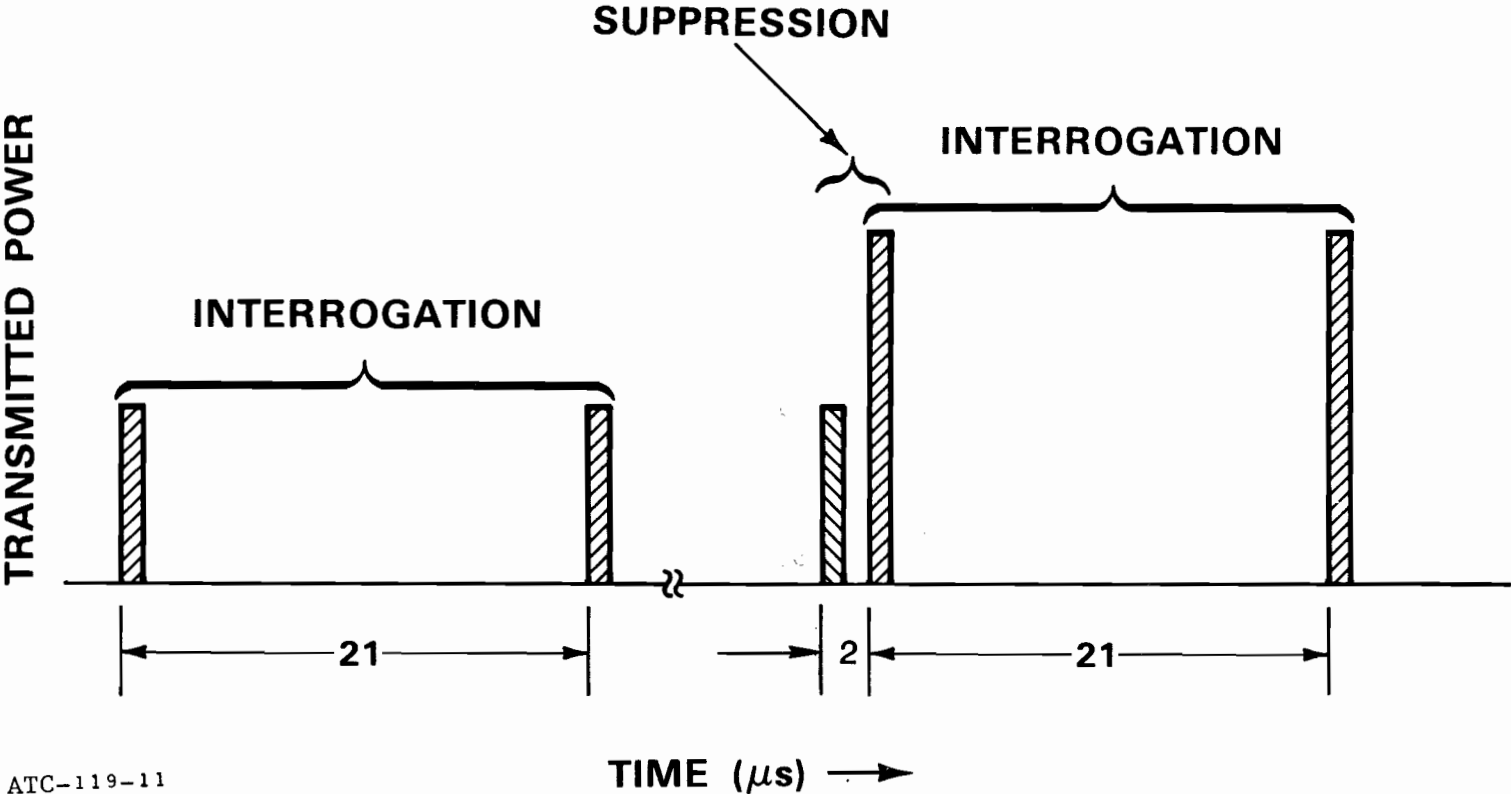

IMPROVEMENTS DUE TO WHISPER-SHOUT

The figure shows how whisper-shout improves the performance of TCAS in an actual synchronous garble situation.

Recorded flight test data are presented showing ATRCBS replies for a number of targets over the New York City area. One interrogation was transmitted at the beginning of each second. A range counter was started and the time-of-arrival was recorded for each valid reply received up to 200 microseconds following the interrogation. A single dot is plotted at the arrival time for each reply, calibrated as range. It is seen that these replies form distinct tracks.

The left-hand plot shows how the system works with a single full-power interrogation once each second. The right-hand plot shows the performance when a 4-level whisper-shout sequence was transmitted and the replies were combined. This 4-step sequence was alternated with the single full-power interrogations for a direct comparison. There is a marked improvement during the time interval at about 100 seconds into the experiment when there were 5 aircraft all within garble range of each other. Whisper-shout also helps combat another major problem, which is multipath. The reason why multipath is a problem is described on the following figure.

IMPROVEMENTS DUE TO WHISPER-SHOUT

SINGLE INTERROGATION

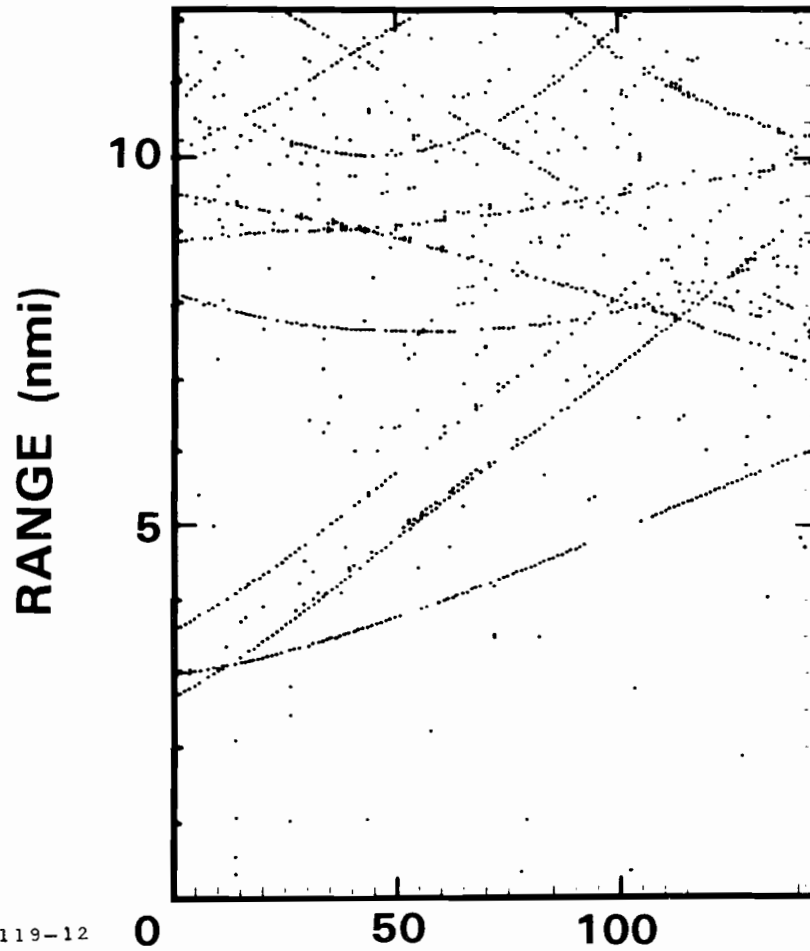

WHISPER-SHOUT

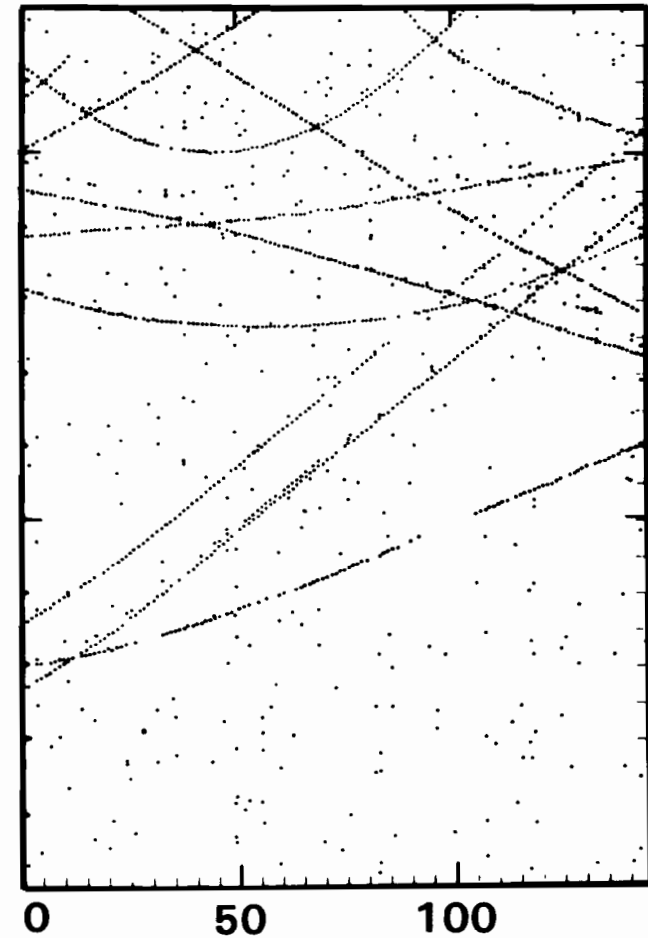

ATC-119-12

TIME (s)

TRANSPONDER ANTENNA PATTERNS

Air traffic control transponders use quarter-wave monopole antennas mounted on the bottom of the aircraft. As is evident from these patterns, which were obtained from scaled-model measurements, a stub antenna of this sort has a peak elevation gain at an angle of -20 to -30 degrees. This is ideal for ground-to-air surveillance. But the direct air-to-air surveillance path operates at a significant disadvantage relative to the reflection path, particularly over water.

TRANSPONDER ANTENNA PATTERNS

(Grumman Gulfstream - Bottom)

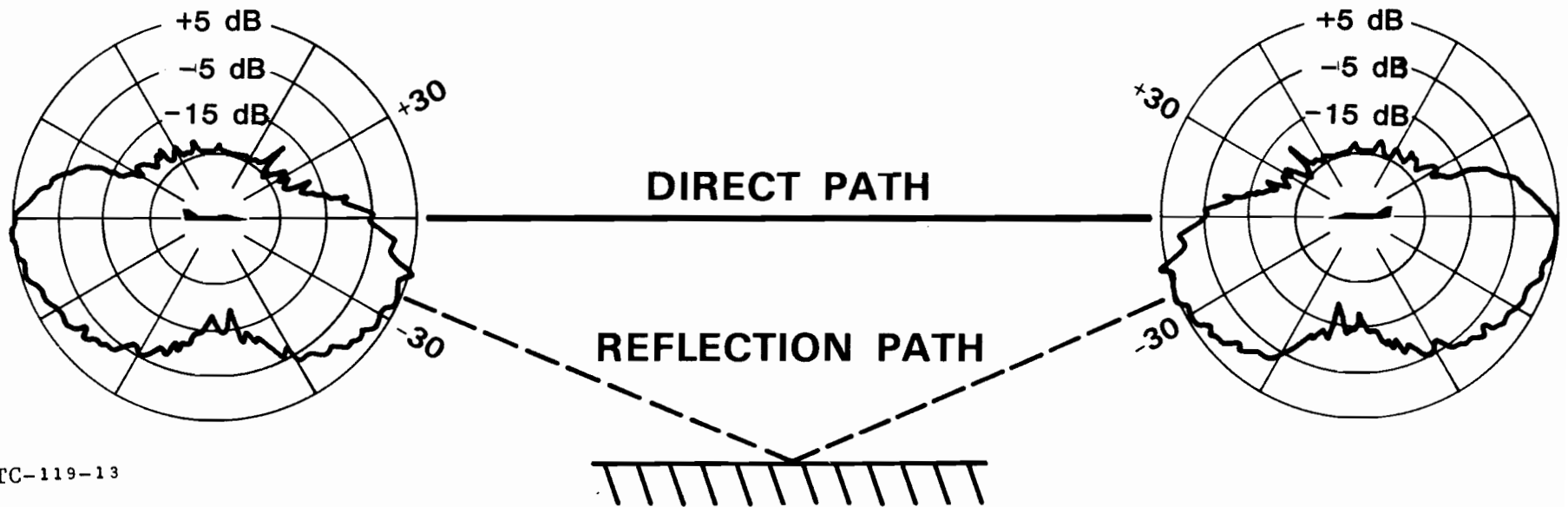

ATC-119-13

MULTIPATH

This figure shows air-to-air multipath data recorded over a calm ocean with both aircraft at about 10,000 feet.

The direct and reflected signal strengths are plotted as a function of time as the two aircraft flew diverging flight paths. The interrogator alternated its transmissions between top and bottom antennas. The top graph shows the relative received signal strengths when the interrogator transmitted from a top-mounted antenna and the bottom plot shows the signal strengths when the bottom antenna was used. The transponder antenna is in the conventional bottom location in both cases.

With the bottom-to-bottom link, there are ranges at which the reflected signal is consistently stronger than the direct signal. As one might expect, this occurs when the grazing angle to the sea is 20° to 30° . But when the top antenna is used for interrogation, the energy is directed upward and the signal-to-multipath ratio remains greater than 10 dB throughout. This indicates that TCAS should use top antennas for interrogation. But even when the top antenna is used, the multipath will still be seen above the typical -74 dBm receiver threshold, and it will garble an ATCRBS reply, which consists of simple, unprotected PAM pulses. Thus, there is need for some way of rejecting the multipath. One way of achieving this rejection is through the use of dynamic thresholding.

AIR-TO-AIR MULTIPATH MEASUREMENTS

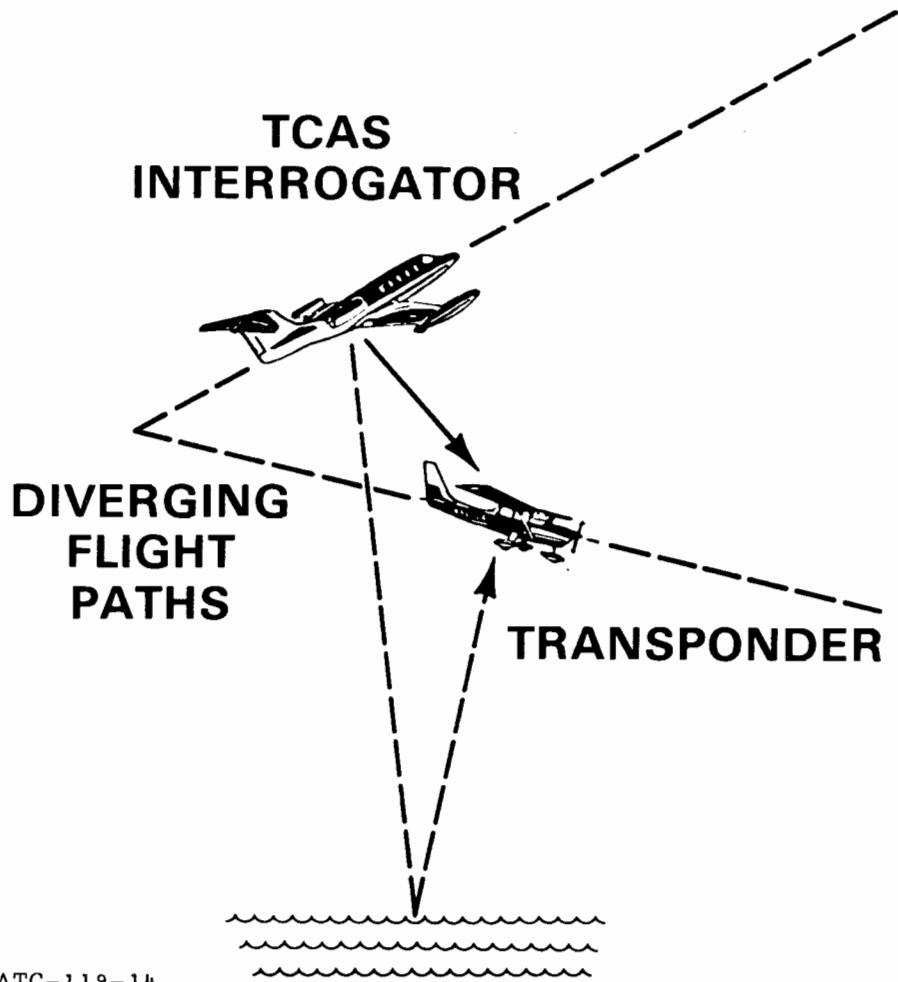

ATC-119-14

RECEIVED POWER LEVEL (dBm)

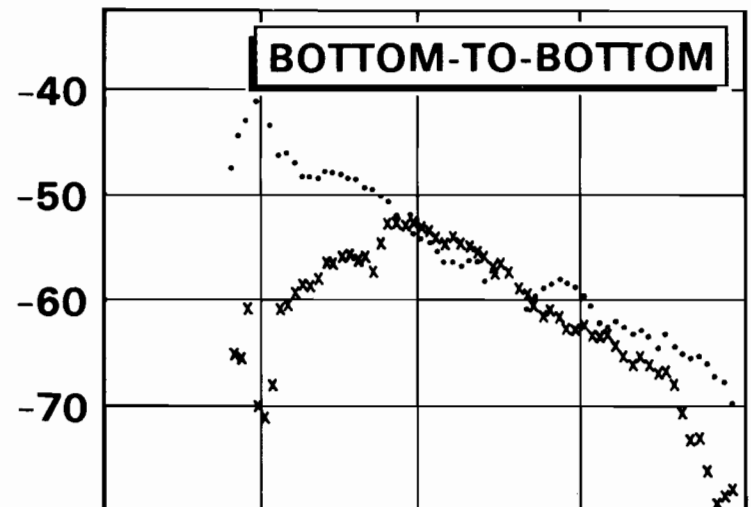
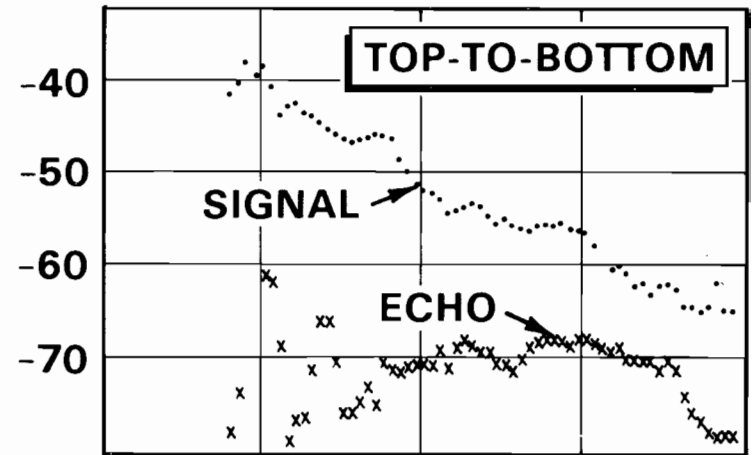

MULTIPATH SUPPRESSION BY DYNAMIC THRESHOLDING

Dynamic thresholding is used in the detection of ATCRBS replies as a means of rejecting low level multipath. Variable thresholds have historically been avoided in ATCRBS reply processors because they tend to discriminate against weak replies. However, when used in conjunction with the whisper-shout technique, this disadvantage of dynamic thresholding is largely overcome. Although on any given step of the whisper-shout sequence it is possible for a strong reply to raise the threshold and cause the rejection of a weaker overlapping reply, most overlapping replies received in response to whisper-shout interrogations are of approximately equal amplitudes since the whisper-shout process sorts the targets into groups by signal strength. Experiments indicate that very few replies are lost by the mechanism of threshold capture when dynamic thresholding is used along with whisper-shout. Thus, these two techniques provide a very useful degree of multipath resistance to the ATCRBS interrogation and reply links.

In addition to making it possible to use dynamic thresholding on the reply link, whisper-shout simultaneously reduces the effect of interrogation-link multipath by assuring that each transponder replies only to interrogations that are received within a few dB of its minimum triggering level. In most situations, this causes the multipath echo to be received below the minimum triggering level of the transponder.

DYNAMIC THRESHOLDING OF ATCRBS REPLIES

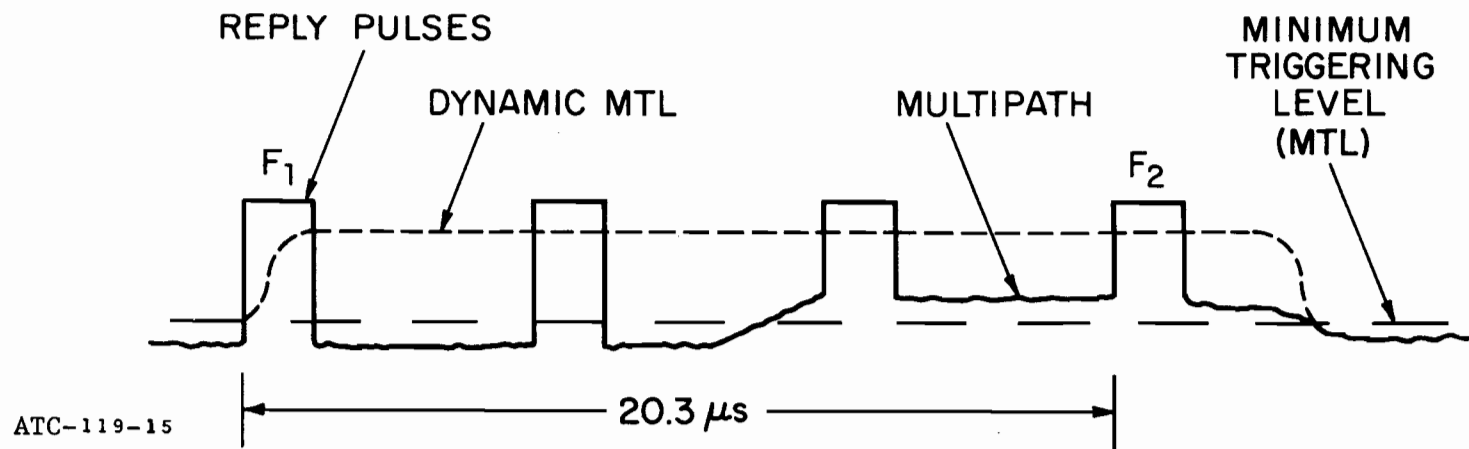

DYNAMIC THRESHOLDING DATA

The figure gives an example of the surveillance improvement provided by dynamic thresholding. This is a plot of the same type of reply information present earlier, with replies received on a bottom antenna in response to interrogations transmitted at 1-second intervals. However, in this plot, a dot is plotted along the ordinate for each pulse received, rather than for each reply.

The pulse code structure for the reply tracks labelled A and B can be seen in the figure:

Track A is a target that has passed the test aircraft and is now diverging. Its transponder has no encoding altimeter, so it replies to the interrogations with bracket pulses only.

Track B is a target that passes close by the test aircraft. Its reply is seen to contain Mode C data as indicated by the presence of data pulses between the bracket pulses.

The extra pulses in the left-hand plot are largely due to multipath.

On alternate seconds, a variable threshold was applied that was set to a level 9 dB below the first received pulse and held there for the duration of an ATCRBS reply. The results are shown in the right-hand plot. It is apparent that during the first part of the encounter with target B, the multipath was consistently more than 9 dB below the amplitude of the first pulse because it never exceeded the dynamic threshold level. When the threshold was restored after each reply, the multipath instantly re-appeared.

IMPROVEMENTS DUE TO DYNAMIC THRESHOLDING

FIXED THRESHOLD

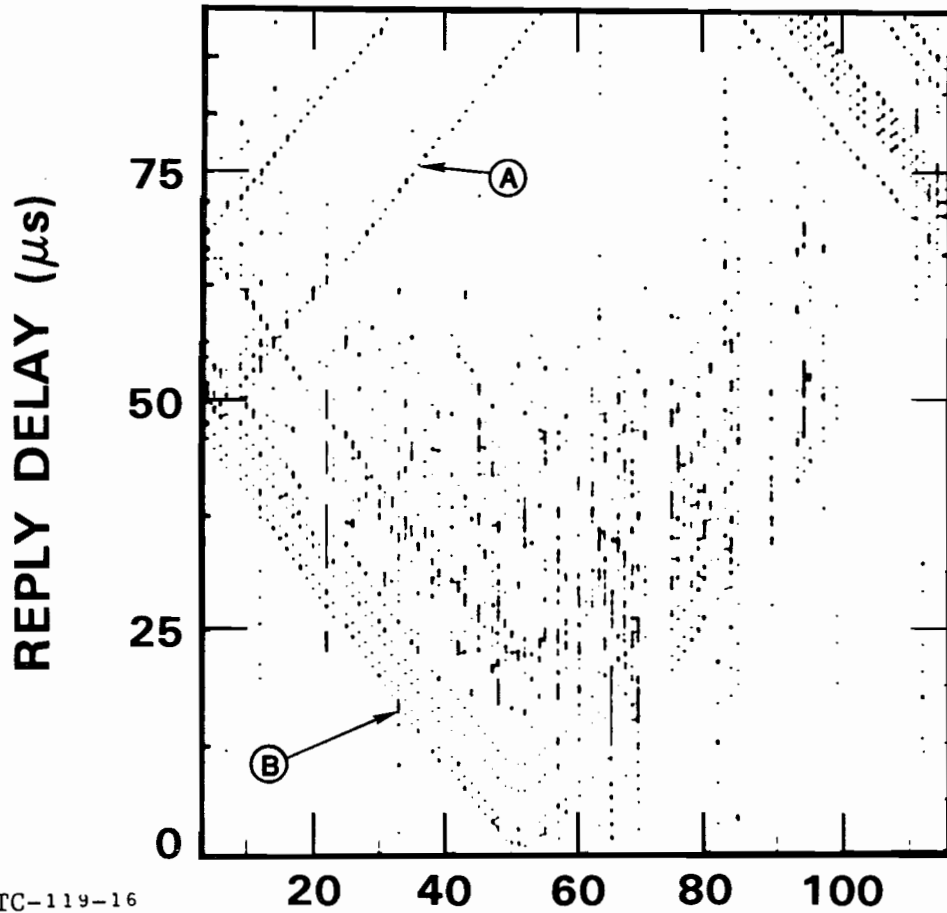

DYNAMIC THRESHOLD

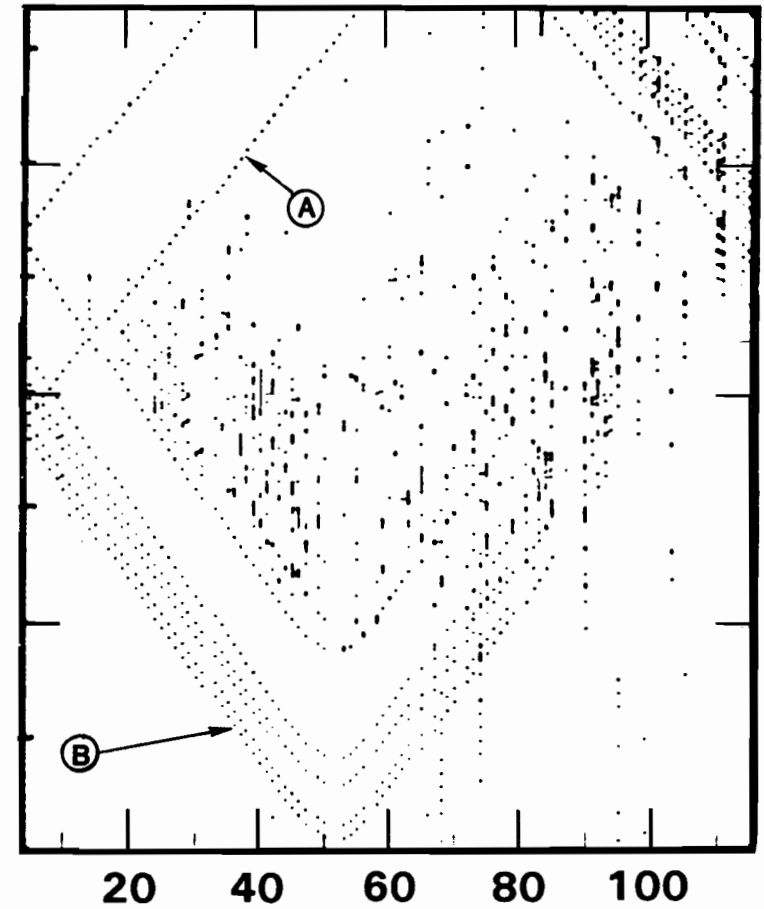

ATC-119-16

INTERROGATION TIME (s)

TCAS II TRACKING OF ATCRBS-EQUIPPED AIRCRAFT

The first step in ATCRBS tracking is to correlate the replies received from the multiple whisper-shout interrogations via each beam of the top antenna, as well as from the omnidirectional bottom antenna. The replies are compared in range and altitude and duplicate replies are merged so that only one report per scan is produced for each ATCRBS aircraft under surveillance.

Reports are correlated in range and altitude with the predicted position of existing tracks. Reports that successfully correlate are used to extend the position of the corresponding track. Reports that fail to correlate with old tracks are compared to previously uncorrelated reports to start new tracks. Before a new track can be started, the replies that lead to its initiation must agree in all of the most significant altitude bits. A geometric calculation is performed to identify and suppress specular false targets caused by reflection from the terrain. New and extended tracks are then merged and checked to see if they qualify for dissemination (as established tracks) to the collision avoidance algorithms.

Tracks become established by meeting a minimum track life requirement. The purpose of this test is to filter spurious tracks caused by garble and multipath that are generally characterized by short track life. The techniques employed for ATCRBS tracking have permitted the use of a track life requirement of 5 seconds rather than the 30 seconds needed for the tracker used in earlier experimental ATCRBS BCAS equipment.

This reduction in track life required for establishing a track is most significant in that it allows a corresponding reduction in required transmitter power. Using a 5-second establishment time, it is calculated that, in the absence of interference, a TCAS II unit with transmitter power and receiver sensitivity specifications identical to those of an air carrier transponder will be able to detect all threatening ATCRBS-equipped aircraft closing at up to 1200 kt with at least 95% probability of success [6].

ATCRBS SURVEILLANCE PROCESSING

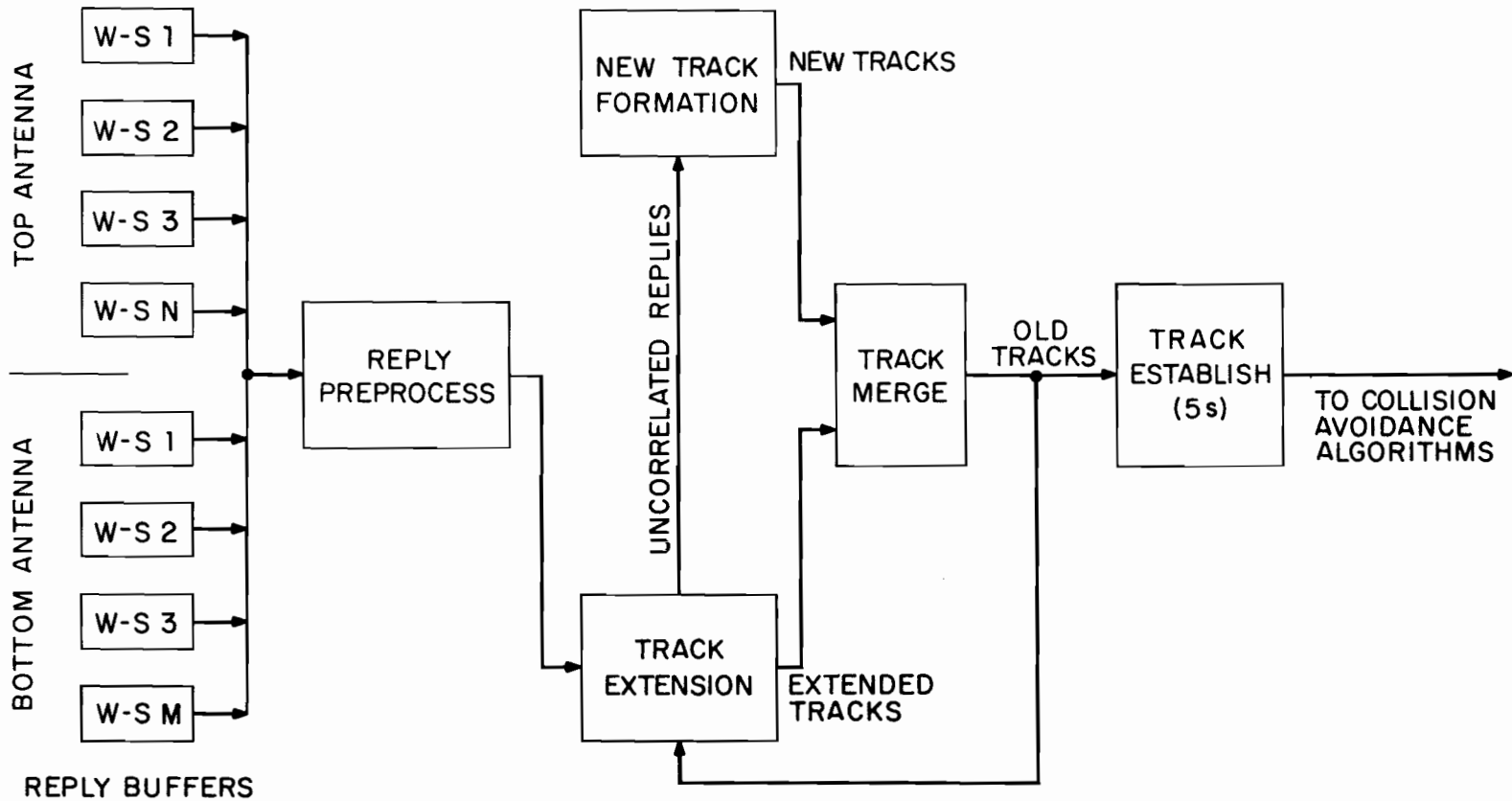

TRACKING ALTITUDE-UNKNOWN AIRCRAFT

When generating traffic advisories, it is important to account for ATCRBS transponders that are not equipped with encoding altimeters. TCAS II can generate traffic advisories on such intruders.

When ATCRBS aircraft with altitude-reporting capability are tracked, the altitude code is used for reply correlation. When there is no altitude code, TCAS II must rely solely on range. For nearby targets, the accuracy of a range-only tracker can be improved if the tracker design takes advantage of the fact that most encounters are non-accelerating. For such encounters, the square of the target slant range is a quadratic function of time with a well-behaved first derivative, whereas linear range rate exhibits strong apparent accelerations. Thus the TCAS II tracks all short-range altitude-unknown aircraft in R^2 with a parabolic least-squares tracker.

TRACKING ALTITUDE-UNKNOWN TARGETS

Unavailability of altitude code reduces reply correlation accuracy.
For non-accelerating encounters, square of range is quadratic in time.

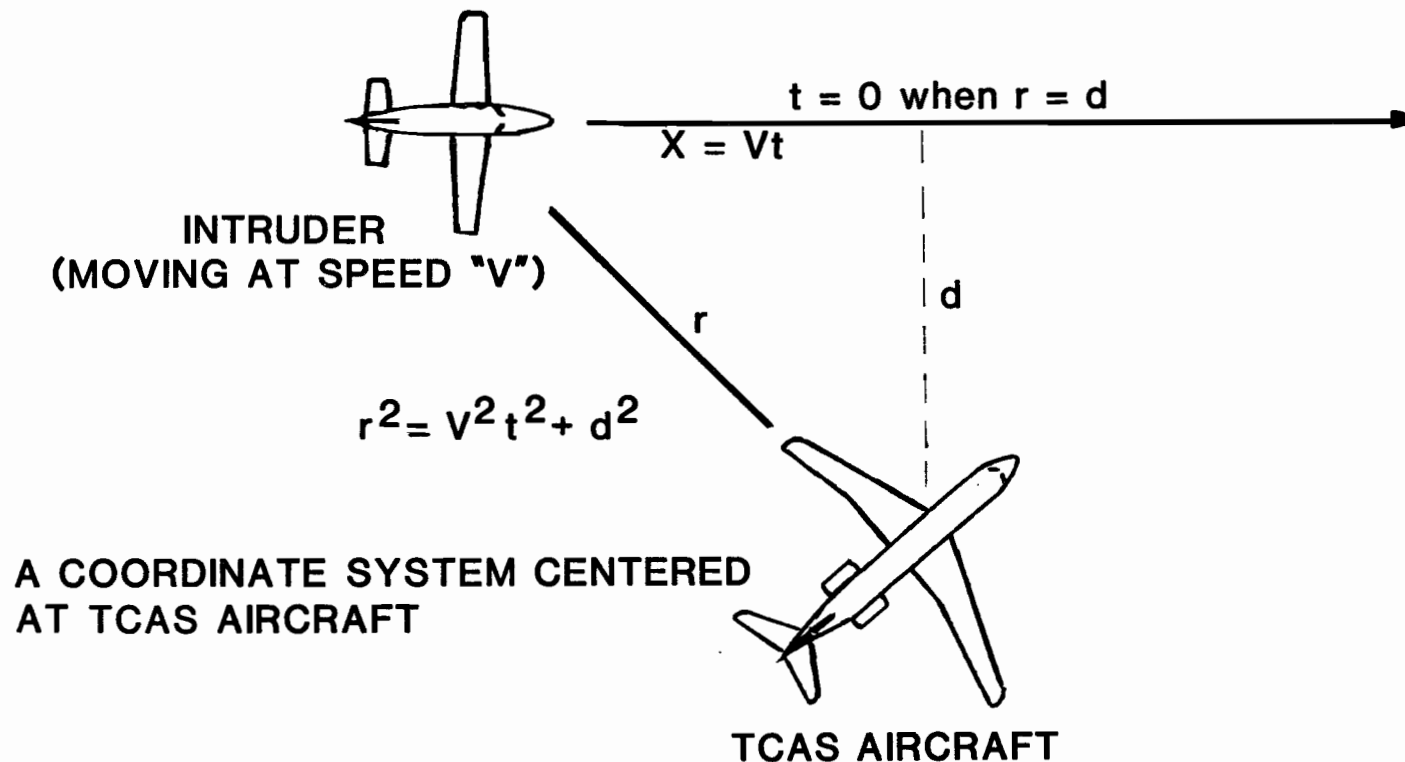

Parabolic , least-squares tracking of r^2 improves predictions at closest approach and allows reliable tracking when altitude correlation is unavailable.

TCAS II ACQUISITION OF MODE S-EQUIPPED AIRCRAFT

The Mode S surveillance subsystem uses a passive technique to determine the addresses of Mode S-equipped aircraft. Passive address acquisition prevents unnecessary interference with other elements of the beacon system [7]. TCAS II listens to the spontaneous replies (termed squitters) generated by all Mode S transponders once per second. The Mode S address in the squitter reply is protected by error coding to ensure a low probability of obtaining a false address. Since the squitter reply does not contain altitude information, the TCAS II attempts to obtain altitude from Mode S replies generated in response to ground interrogations or interrogations from other TCAS aircraft. If altitude is not received shortly after address detection, the Mode S aircraft is actively interrogated to obtain altitude.

EXAMPLE OF MODE S ACQUISITION BY TCAS II

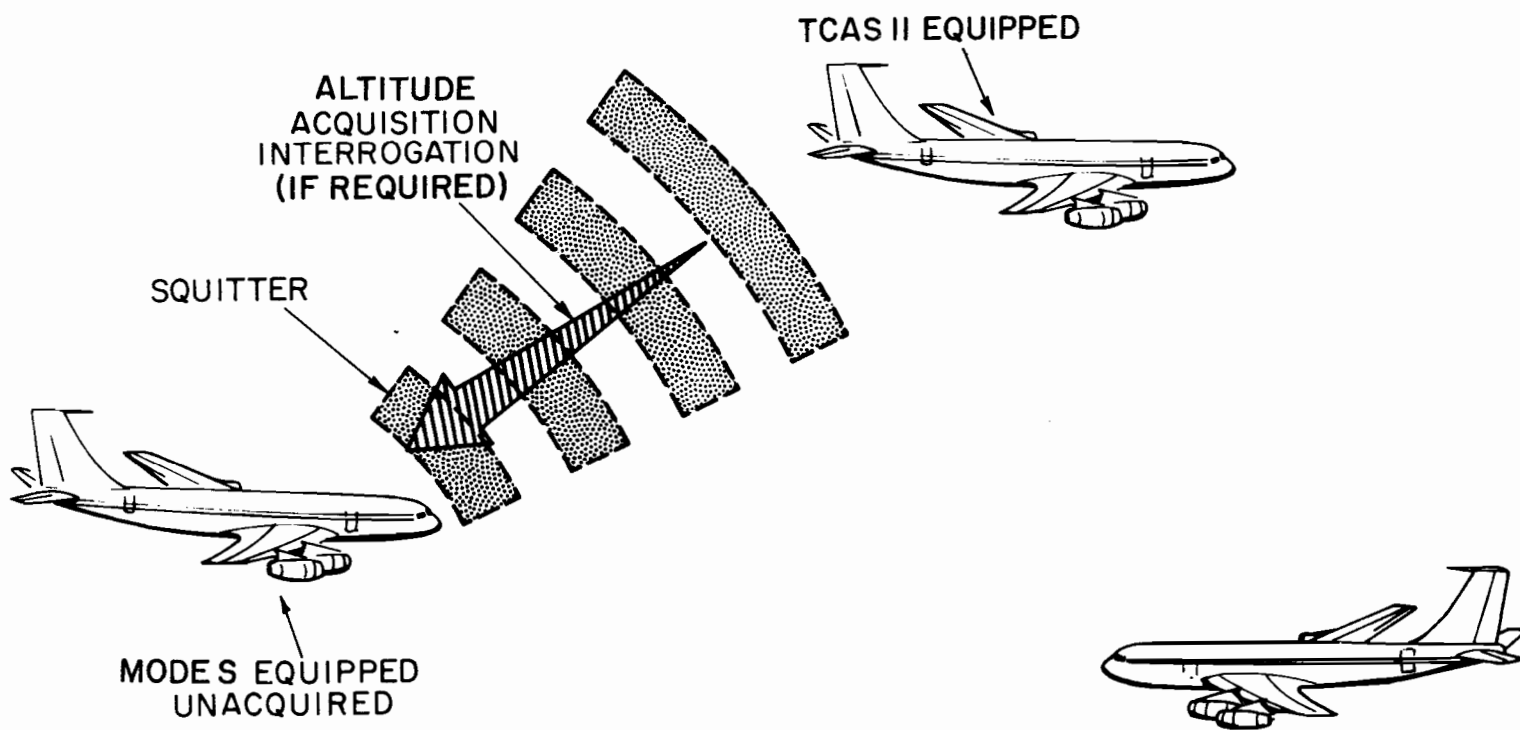

ATC-119-19

MODE S SURVEILLANCE STATES

After TCAS II has acquired the altitude of a detected Mode S aircraft, it compares the altitude of this aircraft to its own altitude to determine whether the target can be ignored or must be interrogated to determine its range (if not already known). If the measured range and the reported speed capability indicate that it is (or could soon be) a collision threat, the target is regularly interrogated by a "roll call" and the resulting track data are fed to the collision avoidance logic. An aircraft at longer range is interrogated only as often as necessary to assure that it will be tracked before it becomes a collision threat. Until this occurs, its address is declared "dormant" and interrogations to that address are temporarily suspended.

The use of passive detection in combination with altitude filtering and dormant addresses minimizes the number of Mode S transmissions required by the TCAS II system. Provision is also included to automatically limit the Mode S interrogation rate when the local density of Mode S transponders and TCAS II aircraft becomes very high.

MODE S SURVEILLANCE STATES

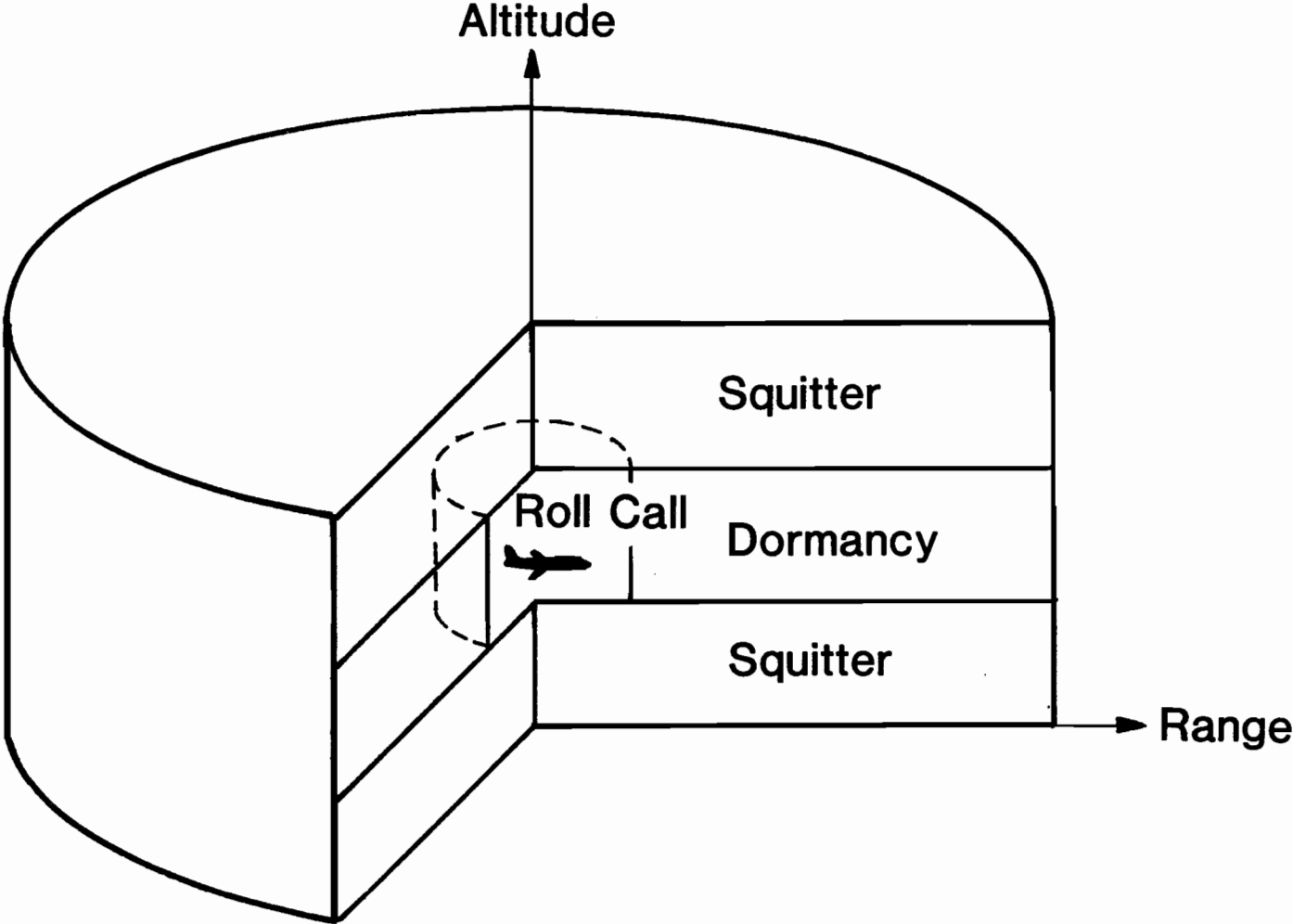

ATC-119-20

TCAS II ROLL CALL SURVEILLANCE OF MODE S-EQUIPPED AIRCRAFT

Air-to-air surveillance of Mode S targets is inherently easier than tracking ATCRBS targets. Since each transponder has a well protected and unique address, the probability of establishing a false track is negligible. The Mode S modulation formats were chosen to be resistant to interference since it was recognized that the Mode S ground system would operate in a heavy ATCRBS environment for a number of years. The only real challenge to the Mode S air-to-air link arises from ground-bounce multipath.

The Mode S interrogation is protected against multipath both by the inherent interference resistance of the binary phase modulation process and by the echo rejection circuitry in the transponder (which protects the Mode S interrogation preamble). The Mode S reply waveform is also protected against multipath. A dynamic thresholding scheme similar to the one previously described for ATCRBS is also used in the Mode S reply processor in TCAS II to protect the reply preamble. Like the interrogation data block, the reply data block is also naturally resistant to multipath since the pulse position demodulation process uses a differential amplitude comparison technique.

Thus, Mode S link failures occur only when the multipath signal strength is almost equal to or greater than the direct signal strength. This occurs relatively rarely, especially when the TCAS II unit transmits and receives through its top-mounted antenna. By using dual antennas and a reinterrogation capability in the TCAS II unit, and by using dual antennas on the Mode S aircraft, it is found that near perfect tracking of Mode S threats is achieved. If the Mode S intruder is equipped with only a bottom-mounted antenna, surveillance performance is somewhat degraded.

EXAMPLE OF MODE S ROLL-CALL TRACKING

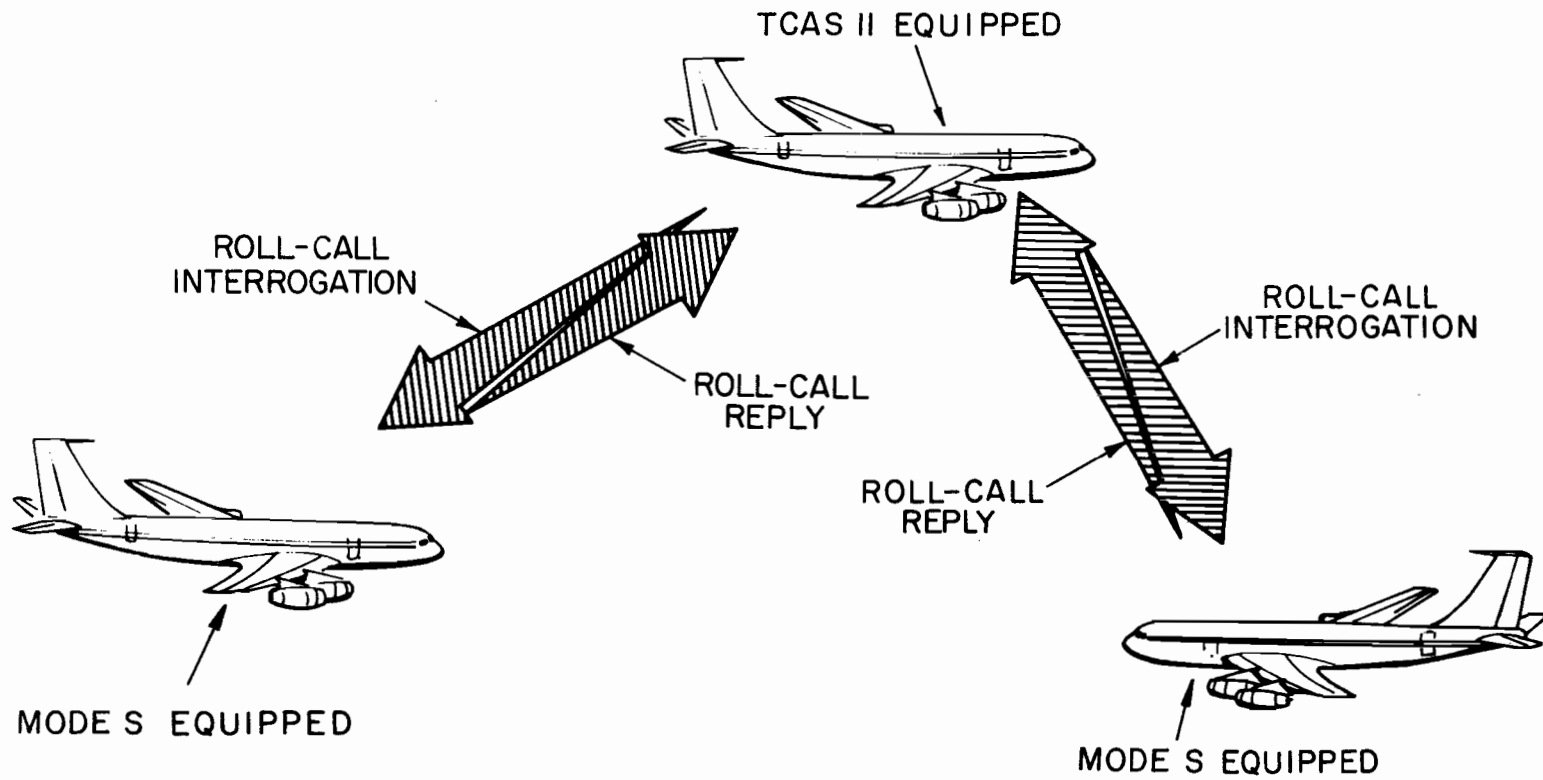

ATC-119-21

COLLISION AVOIDANCE ALGORITHMS*

TCAS II performs its aircraft separation assurance function by displaying to the pilot traffic advisories for potential collision threats, and resolution advisories to designate maneuvers required to achieve safe separation. The TCAS II collision avoidance algorithms use the tracks formed by the TCAS II surveillance function to make this determination. The principal functions of the TCAS II collision avoidance algorithms are threat detection, resolution, and communication and coordination [8].

All airborne, altitude-reporting aircraft that are tracked by TCAS II are considered intruders. TCAS II evaluates each intruder through a prescribed sequence of tests to declare the intruder a threat or a non-threat. The characteristics of an intruder that are examined to determine if it is a threat are its altitude, altitude rate, range, and range rate.

TCAS II generates resolution advisories for all intruders declared threats. Each threat is processed individually for selection of the appropriate resolution advisory based on track data and coordination with other TCAS II equipped aircraft.

TCAS II airborne units communicate with other TCAS II aircraft. Coordination communications involve the air-to-air transmission of maneuver selections to assure the display of compatible resolution advisories.

Advisories generated by TCAS II are displayed to the pilot on suitable cockpit displays. The advisories are removed when an intruder becomes a non-threat.

* The collision avoidance algorithms are being developed by the MITRE Corporation.

TCAS II COLLISION AVOIDANCE ALGORITHMS

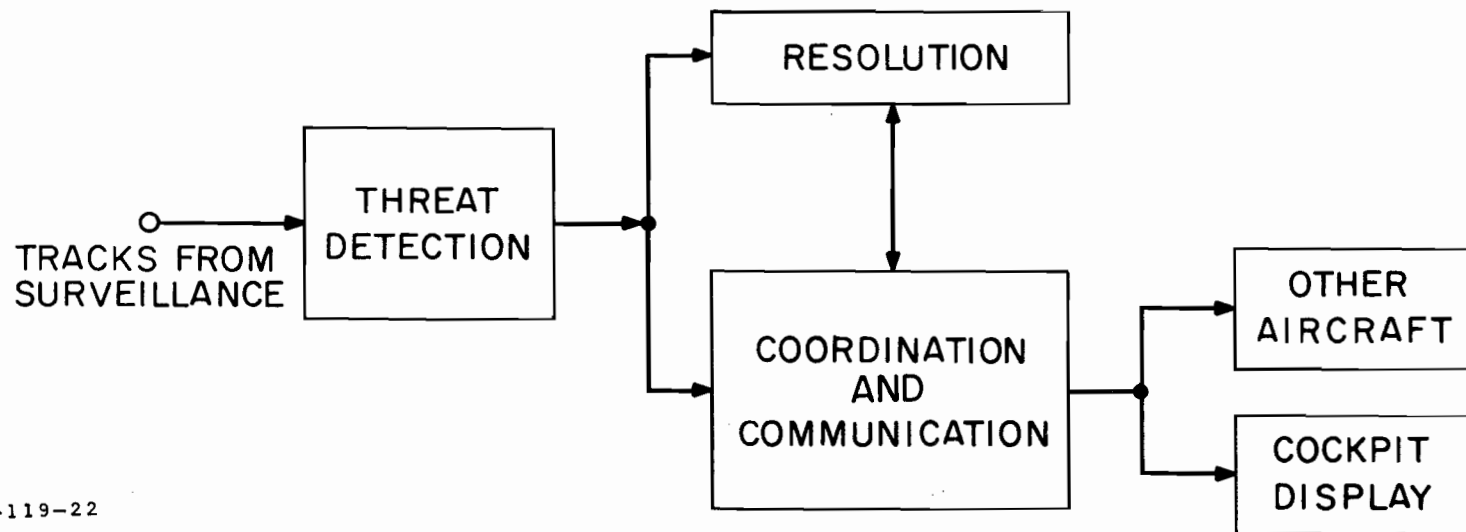

ATC-119-22

TCAS ANGLE-OF-ARRIVAL

The purpose of the angle-of-arrival system used in the minimum TCAS II is to measure the direction of nearby aircraft with sufficient accuracy to aid the pilot in visually acquiring the aircraft. The angle-of-arrival system does not necessarily produce a directional beam with antenna gain in the horizontal plane; the receiving antenna patterns may be omnidirectional.

TCAS ANGLE OF ARRIVAL

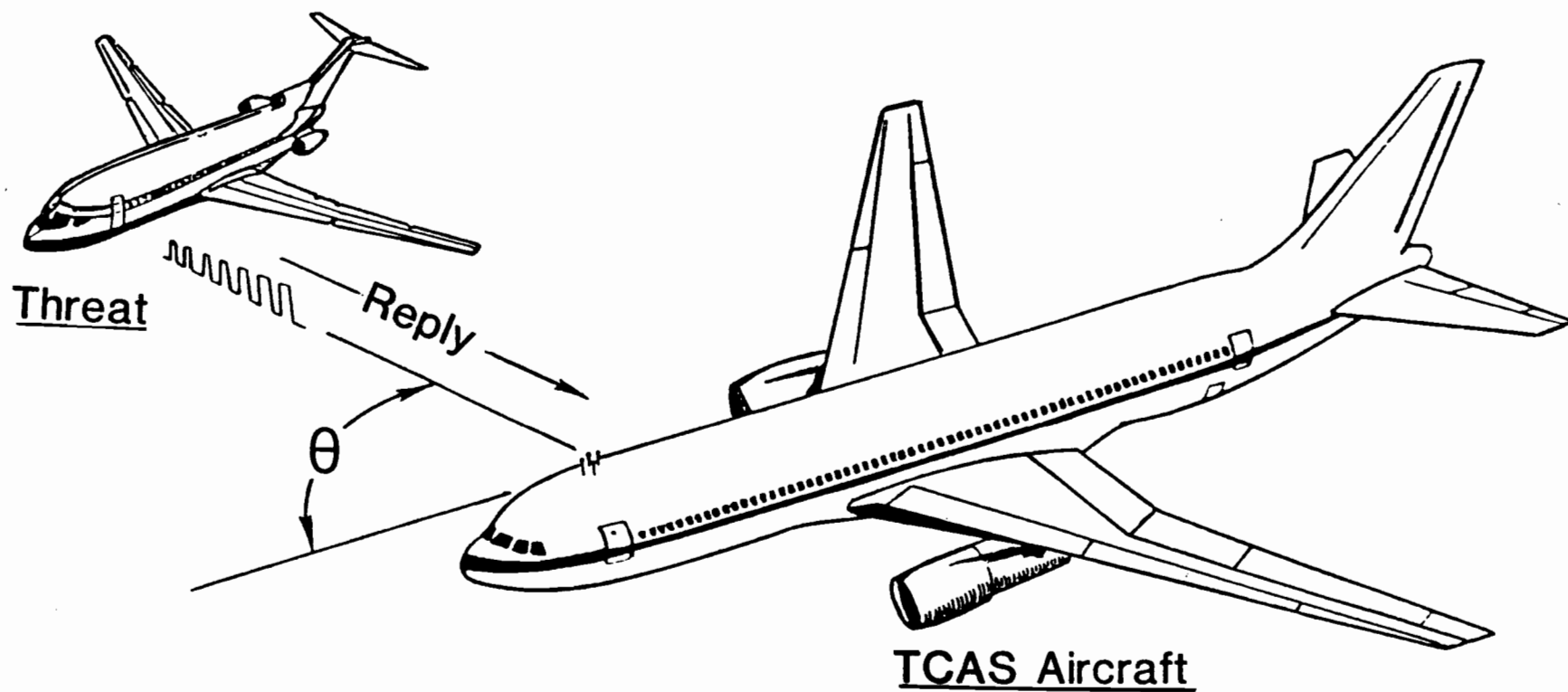

ATC-119-23

INTERFERENCE-LIMITING ALGORITHM

A set of three inequalities has been devised to assure that no transponder is turned off by TCAS II activity for more than 2 percent of the time and for assuring that TCAS II does not contribute to an unacceptably high fruit rate. It is necessary for each TCAS II unit to account for other TCAS II aircraft in its vicinity when limiting its own transmissions. As the number of TCAS II aircraft increases, the interrogation allocation for each of them must decrease. Thus, every TCAS II unit must monitor the number of other TCAS II units (NT) within detection range. This information is then used along with the knowledge of own interrogation rates and powers (ΣP) and own mutual suppression rates (ΣM) to determine the maximum allowable power and maximum sensitivity for ATCRBS and Mode S interrogations within the next surveillance update interval.

The presence of a TCAS II aircraft is announced by the periodic transmissions of a TCAS interrogation containing a message that gives the Mode S address of the TCAS II aircraft. This transmission is sent every 10 seconds using a Mode S "broadcast" format. Mode S transponders are designed to accept message data from a broadcast interrogation without replying. The announcement messages received by the TCAS II's Mode S transponder are monitored by the interference limiting algorithms to develop an estimate of the number of TCAS aircraft (NT).

INTERFERENCE LIMITING ALGORITHM

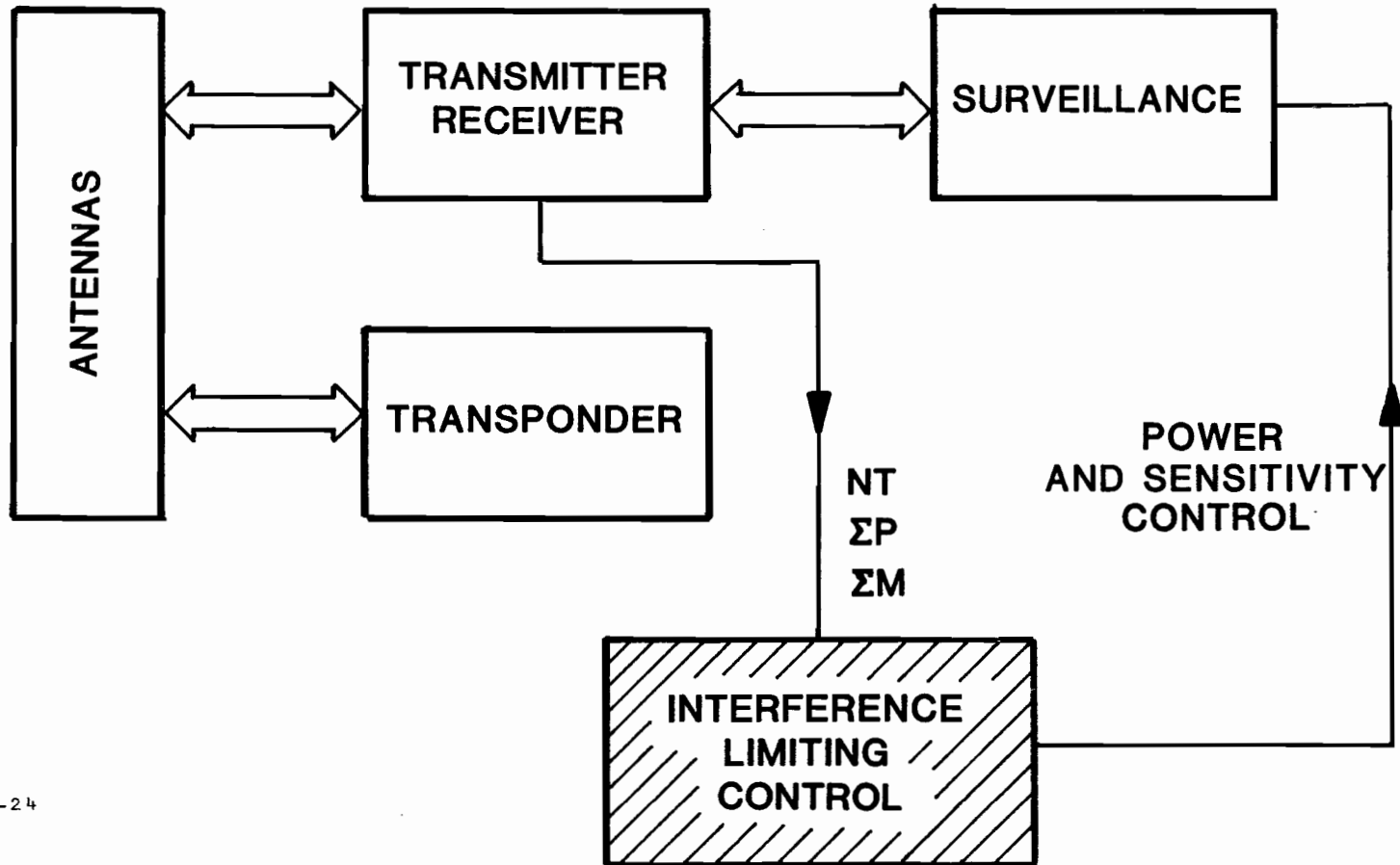

ATC-119-24

MINIMUM TCAS II DESIGN SUMMARY

The minimum TCAS II design is summarized in this table. TCAS II employs a 4-beam directional antenna located on top of the aircraft. Transmit sidelobe suppression is used to control the effective interrogation beamwidth. The angle-of-arrival of the detected aircraft is determined by means of a monopulse bearing estimation technique. The bearing estimate is used to reject replies received from directions other than the current pointing direction of the antenna. The role of the bottom antenna is limited in the TCAS II design to minimize multipath-generated false targets. A high-resolution whisper-shout sequence is used. Although a total of 83 interrogations are transmitted each second, the interference limits are satisfied by transmitting most of these interrogations at very low power. The peak power in the side beams is 4 dB below the peak power transmitted in the forward direction. The peak power aft is 9 dB below the forward power.

Mode S surveillance is accomplished by listening to squitters alternately on the top and bottom antennas. The design splits the listening time equally between these two antennas.

MINIMUM TCAS II DESIGN

TOP ANTENNA

4 Beams, 90°, Transmit SLS,
AOA on reception

BOTTOM ANTENNA

Omni monopole

WHISPER-SHOUT

Top-Forward	24 Levels
Top-Right	20 Levels
Top-Left	20 Levels
Top-Aft	15 Levels
Bottom	4 Levels

COVERAGE IN AZIMUTH

Side beams -4 dB, Aft beam -9 dB

SQUITTER RECEPTION

1 Receiver time shared between top
& bottom antennas

AIRBORNE PERFORMANCE MEASUREMENTS

THE TCAS EXPERIMENTAL UNIT (TEU)

A principal tool for validating the design of the TCAS II surveillance functions has been the Lincoln Laboratory TCAS Experimental Unit (TEU), a real-time implementation of a complete omnidirectional TCAS airborne unit.

The TEU uses a minicomputer for all of its software functions. This machine contains 32K of core and has a 1-microsecond cycle time. The Mode S transponder is physically independent of the TEU and uses a separate pair of antennas. A single 1090-MHz receiver is used by the TEU for the detection of transponder replies. TCAS Mode S interrogations are transmitted from the antenna that successfully communicated with the target on the last scan, and the same antenna is used for receiving the reply. The modulation control unit formats both ATCRBS and Mode S interrogations. The ATCRBS/Mode S reply detector includes video pulse processing and reply decoding circuits for both types of replies. False Mode S preambles are rejected by the Mode S reply decoder which decodes the Mode S PPM format and the Mode S parity code. The ATCRBS reply decoder searches the received pulse train for framing pulse pairs and decides which altitude code pulses are present in each reply. It also determines the target range, flags those code pulses that are potentially garbled, and rejects all phantoms (bracket pairs that could be code pulses belonging to other replies). All further reply processing and tracking is performed in software.

TCAS EXPERIMENTAL UNIT

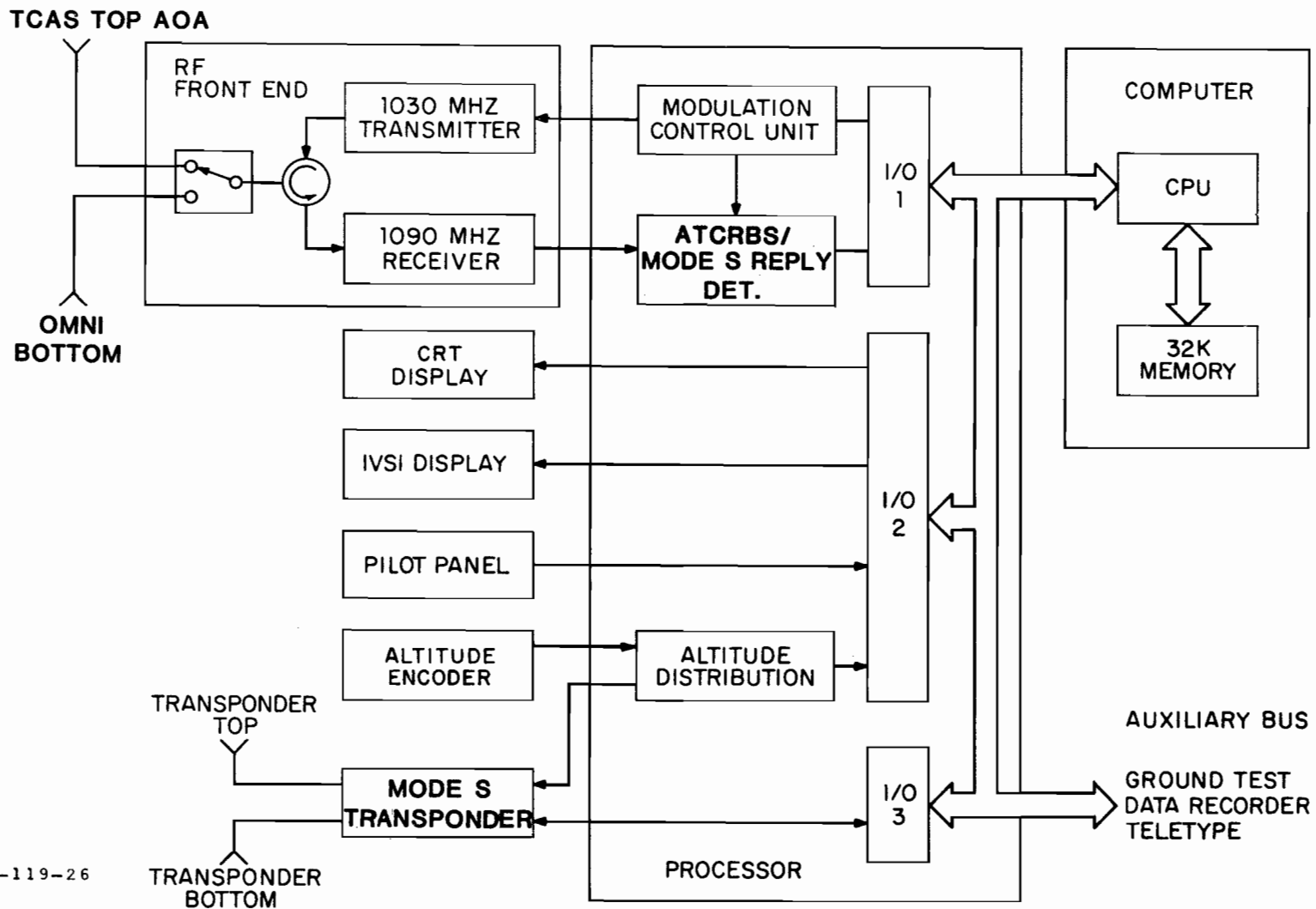

ATC-119-26

TCAS EXPERIMENTAL UNIT CHARACTERISTICS

The TEU surveillance characteristics are summarized in the following table:

Peak Transmit Power (at RF Port):	500 W
Receiver Sensitivity (at RF Port):	-77 dBm (16 dB S/N)
Maximum Range:	14 nautical miles*
Track Capacity:	50 targets, total ATCRBS and/or Mode S
Antennas:	AOA top, omni bottom
Maximum Target Closing Speeds	
Range:	1200 kt
Altitude:	12,000 ft/min

*Receiver range gate setting; TEU is capable of 20-nmi serviceable range.

A photograph of the TEU is shown in the figure. From left to right are shown the computer, the processor, the modified instantaneous vertical speed indicator which is used for display of resolution advisories, and the RF front end.

COMPUTER

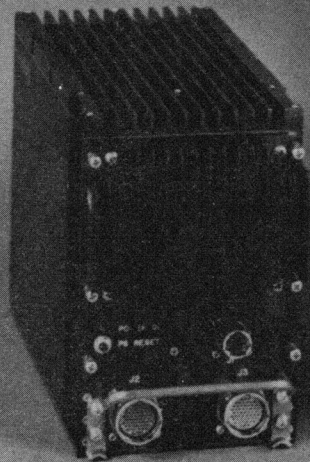

PROCESSOR

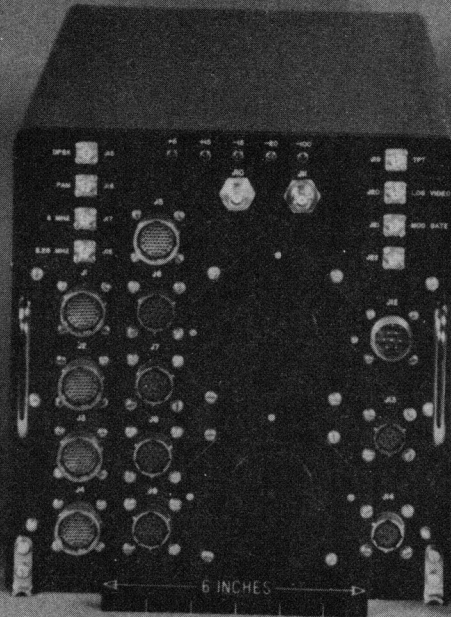

IVSI



RF FRONT END

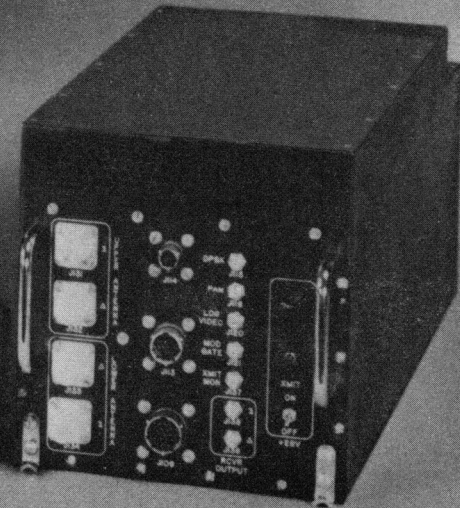

TCAS EXPERIMENTAL UNIT

CP130-652B
ATC-119-27



ATCRBS SURVEILLANCE PERFORMANCE - CONTROLLED ENCOUNTERS

The performance of the ATCRBS surveillance mode has been tested against the collision geometry that occurred in the 1978 mid-air collision in San Diego, California, between a Boeing 727 and a Cessna 172. The results presented in the figure show an actual range-versus-time plot generated by the TEU for an encounter staged with the same aircraft types that were involved in the real collision. The surveillance data for the Cessna 172 aircraft (equipped with a conventional ATCRBS transponder with bottom-only antenna) shows perfect tracking performance throughout the encounter.

The other tracks in the figure represent chance targets in the area at the time the test was conducted. The short false tracks exhibited are typical of surveillance performance at the low altitude of the encounter. These multipath-induced tracks always occur at greater range than the real target track and rarely lead to false alarms.

SAN DIEGO COLLISION GEOMETRY EXAMPLE

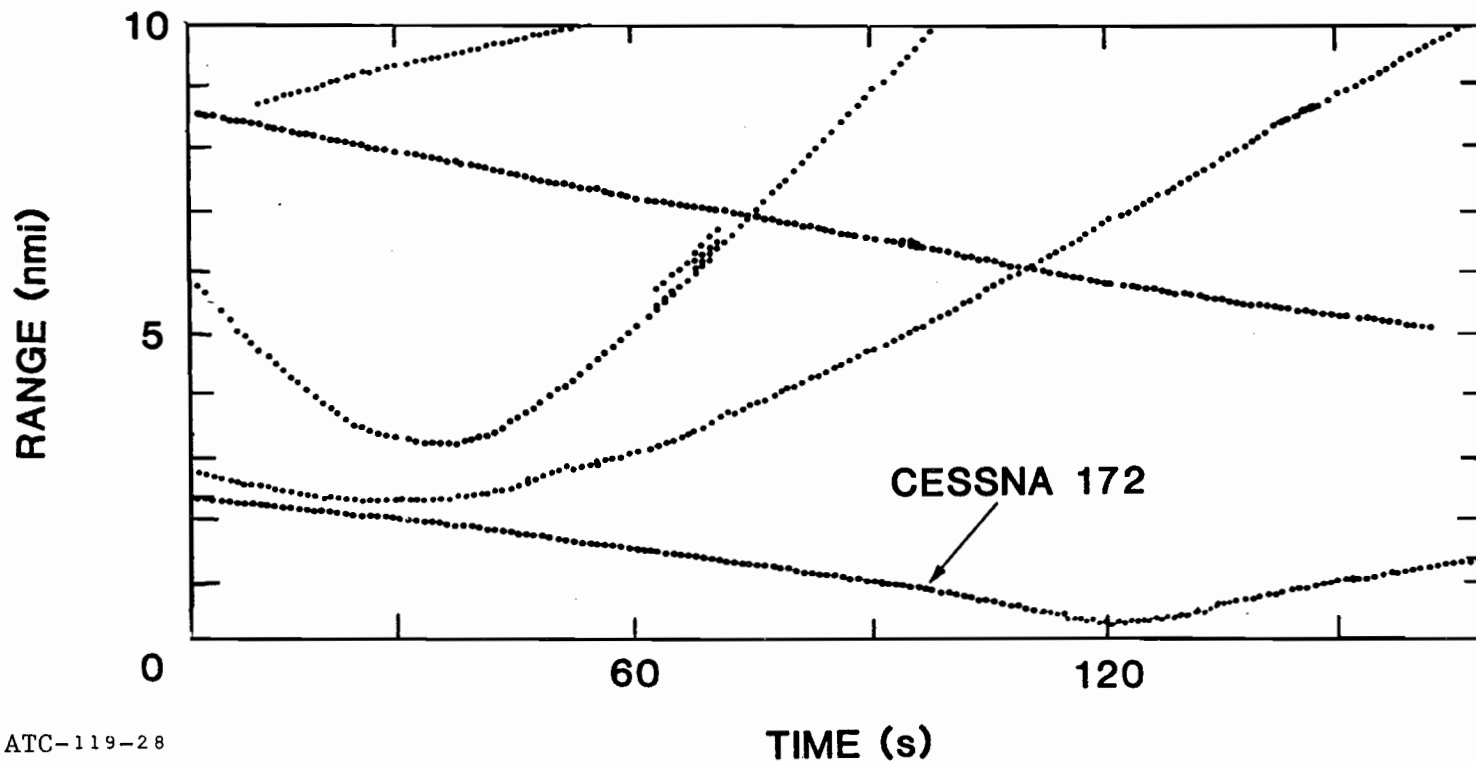
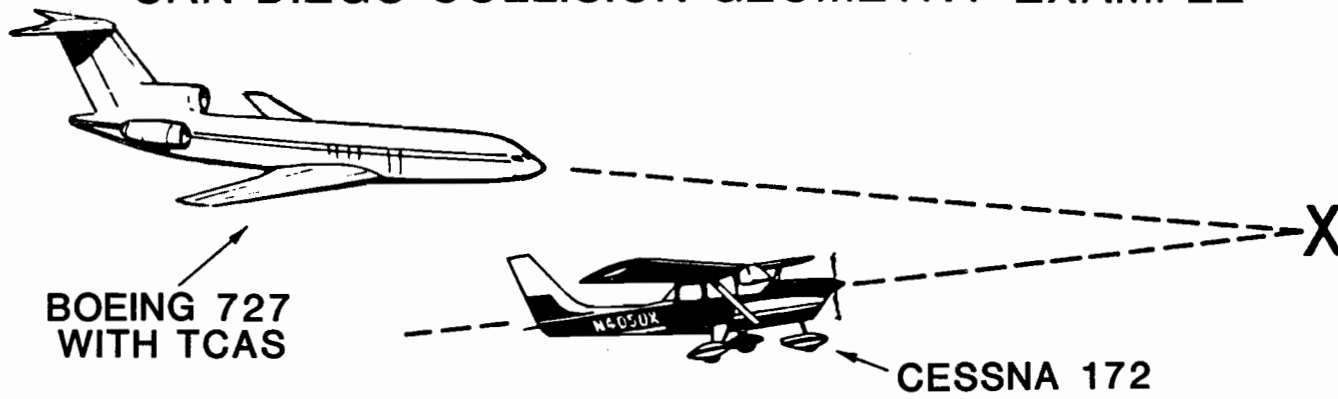

ATCRBS SURVEILLANCE PERFORMANCE - TARGETS OF OPPORTUNITY

In addition to staged encounters, flights have been conducted to collect ATCRBS surveillance data on chance targets equipped with ATCRBS transponders. An example of the results of this type of test is shown in the figure and represents the performance of TCAS in head-on high-speed encounters. Encounter conditions and surveillance performance for the plots labelled A and B were as follows:

CASE	TCAS ALTITUDE (FT)	OTHER ALTITUDE (FT)	CLOSING SPEED (KT)	POINT OF CLOSEST APPROACH (NMI)	ACQUISITION RANGE (NMI)	ACQUISITION TIME*
A	30,300	28,800	990	0.3	11.2	43
B	30,300	32,700	960	0.4	9.3	36

*Seconds prior to point of closest approach.

CHANCE HIGH SPEED ENCOUNTER EXAMPLES

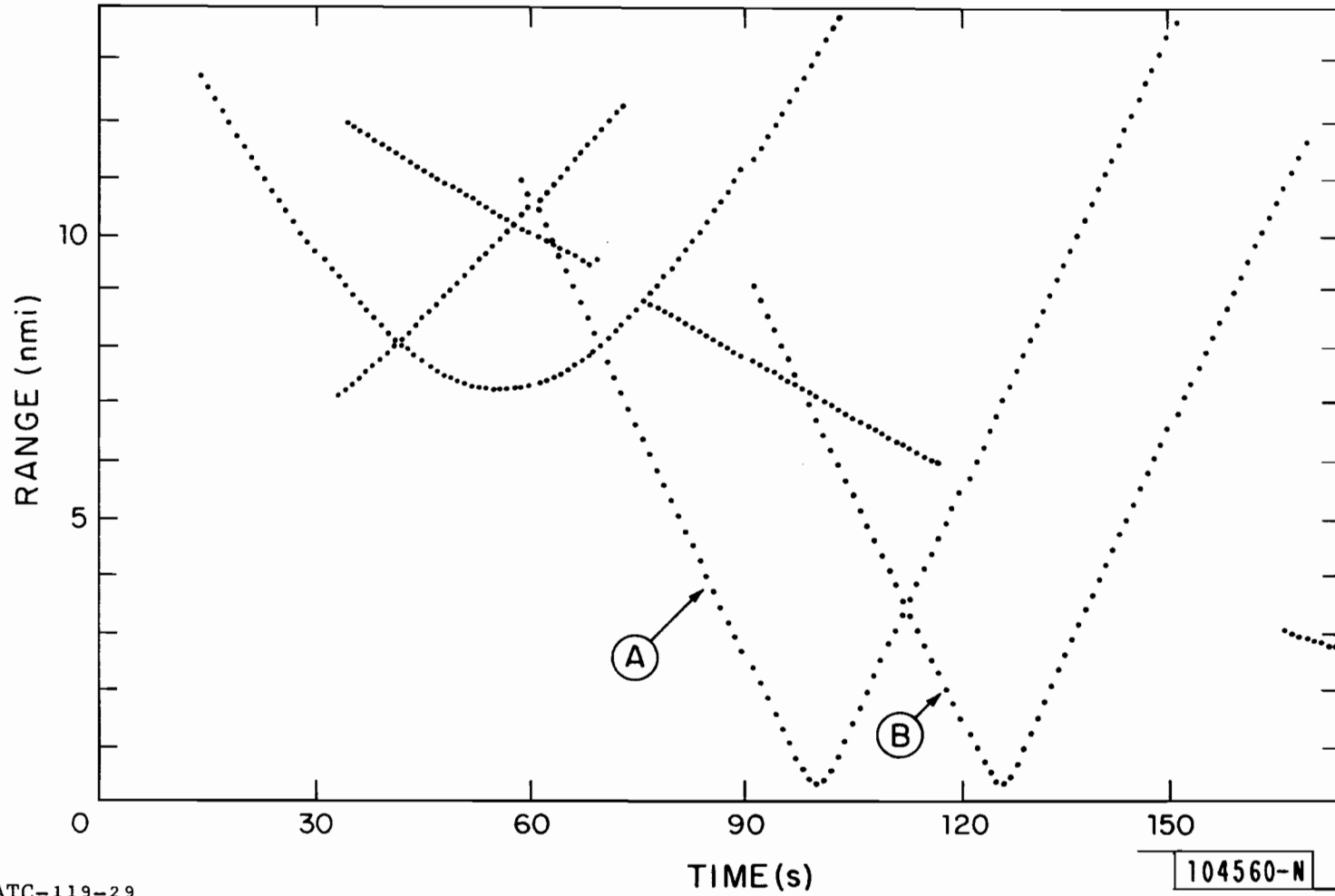

ATC-119-29

104560-N

BEARING MEASUREMENT PERFORMANCE

PLAN-POSITION DISPLAY FOR ENCOUNTER WITH ATRBS AIRCRAFT

This is a plot of the track history for an aircraft flown on an intentional near-miss encounter. The plot includes both airborne track data and ground-derived data transformed to a common coordinate system. These plots use approximately the same format as displayed in the cockpit of the flight test aircraft. For comparison, the aircraft display symbol (triangle) used on the cockpit display in the test aircraft is drawn to scale at the end of the track plot. It is evident after averaging and smoothing, that the tracked data includes both random and non-random error components with the largest apparent error being an angle bias.

PLAN-POSITION DISPLAY FOR ENCOUNTER WITH ATCRBS AIRCRAFT

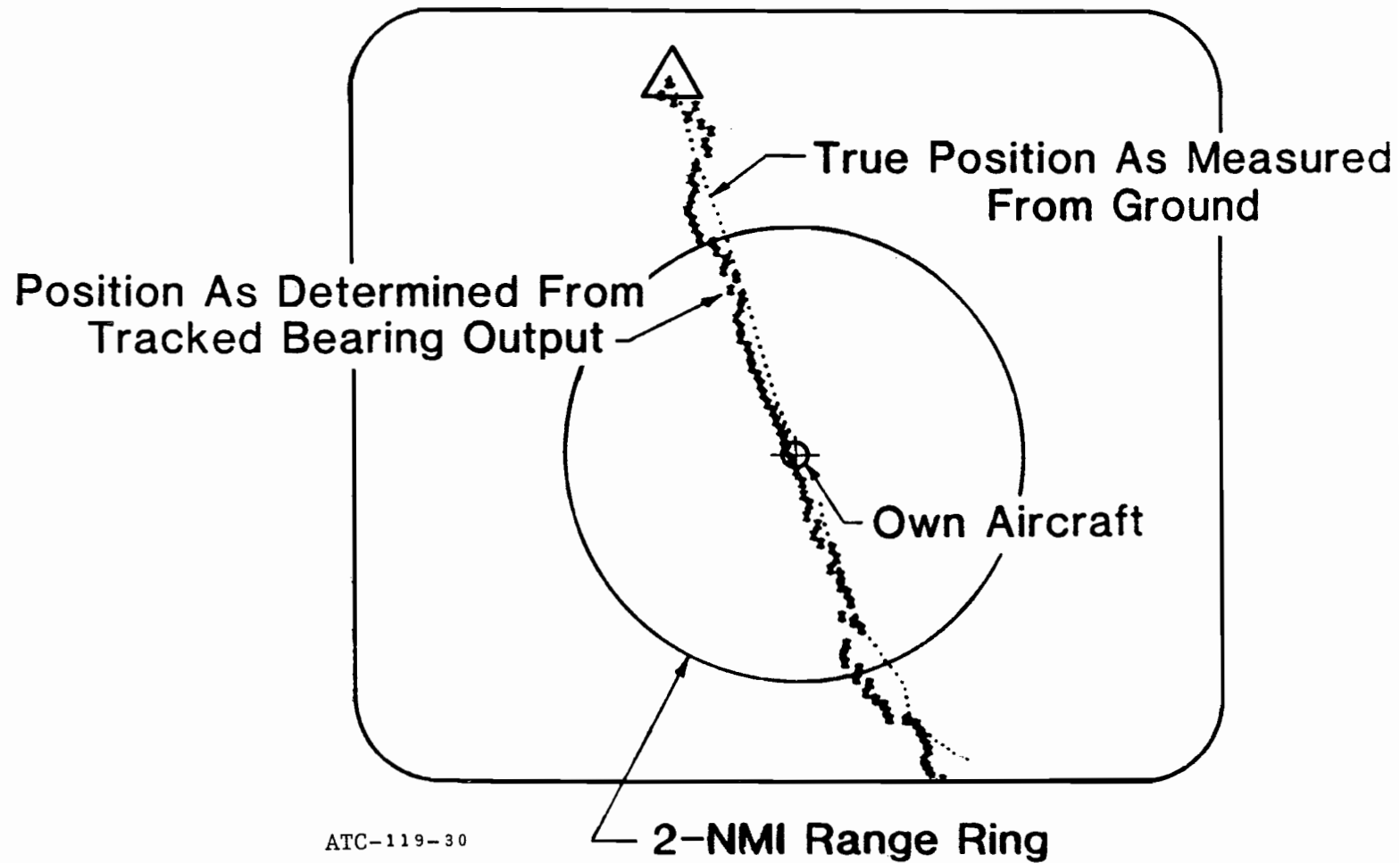

ATC-119-30

MODE S SURVEILLANCE PERFORMANCE

Flight tests of controlled encounters were conducted using the TEU to verify Mode S surveillance performance in operationally interesting geometries. Tests were conducted with the TCAS equipment mounted in several different aircraft, including a Boeing 727. Test scenarios were usually flown at low altitude over land and water to achieve the worst-case multipath environment. The figure shows an example of Mode S surveillance using the 727 as the TCAS aircraft and a Beechcraft Bonanza as the conflicting aircraft. The dots are plotted at 1-second intervals and indicate a successful track update each scan. The range and relative altitude are plotted as seen from the TCAS aircraft. As the aircraft converge, time proceeds from right to left. The level altitude track was begun at a range of more than 11 miles. The target was kept dormant until it was 7 miles away. The symbol 25 indicates the location of the target 25 seconds before closest approach. In all three encounters the tracks were established well in advance of this time. The results are typical of the performance seen in all of the encounters run to date, i.e., near perfect performance against an aircraft equipped with a Mode S diversity transponder. The bottom-most trajectory represents a reenactment of the geometry of the collision that occurred at San Diego in 1978. The closing speed for this encounter is sufficiently slow so that the dots merge into a solid line.

MODE S PERFORMANCE EXAMPLE-(WITH DIVERSITY)

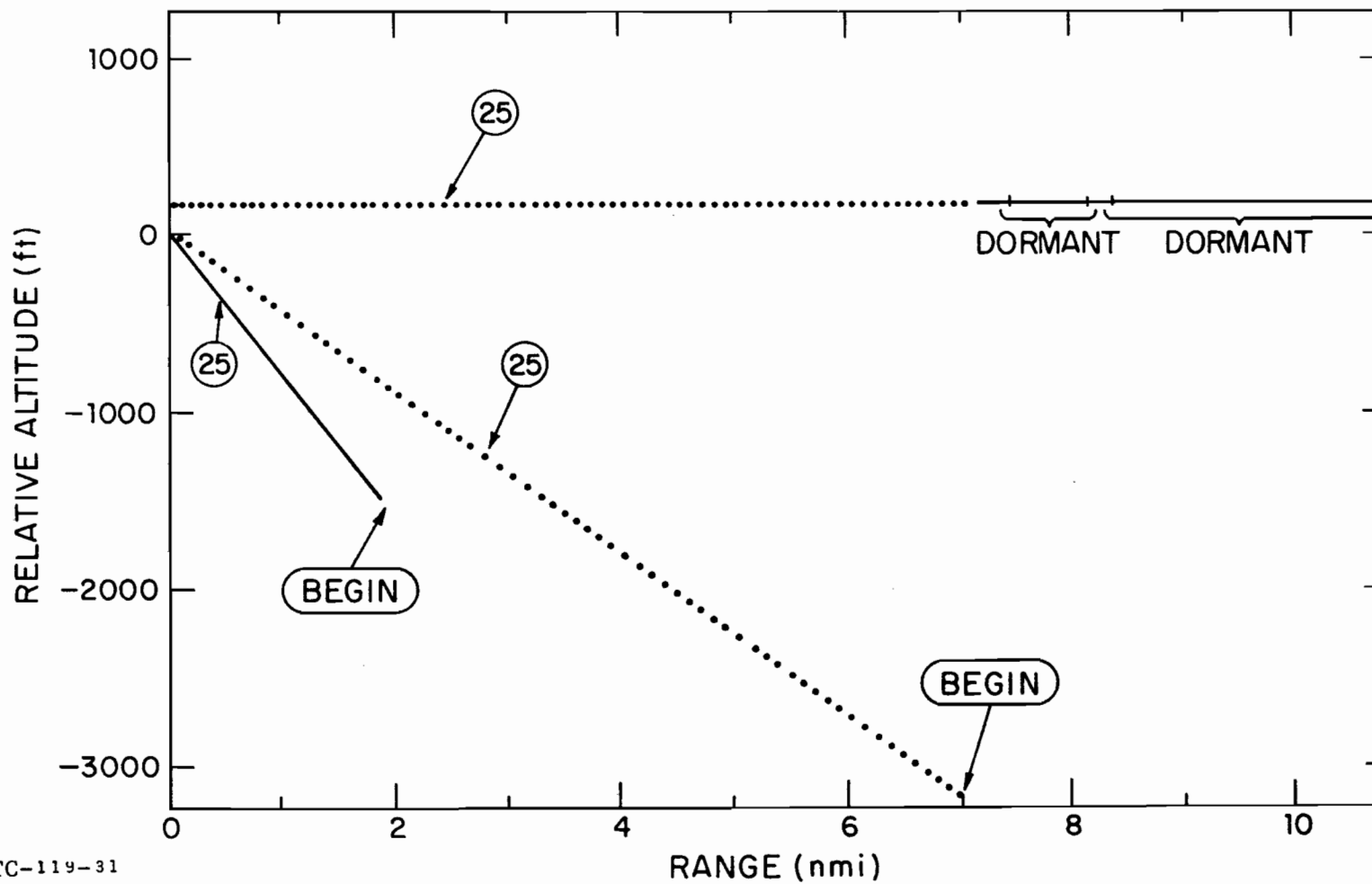

ATC-119-31

BEARING MEASUREMENT PERFORMANCE

PLAN-POSITION DISPLAY FOR ENCOUNTER WITH MODE S AIRCRAFT

This plot shows the same encounter as that of the plan-position display figure for ATCRBS except that the intruder aircraft was tracked with Mode S interrogations. There is less randomness in this plot as would be expected for Mode S replies, but the non-random error component is consistent with the previous figure.

PLAN-POSITION DISPLAY FOR ENCOUNTER WITH MODE S AIRCRAFT

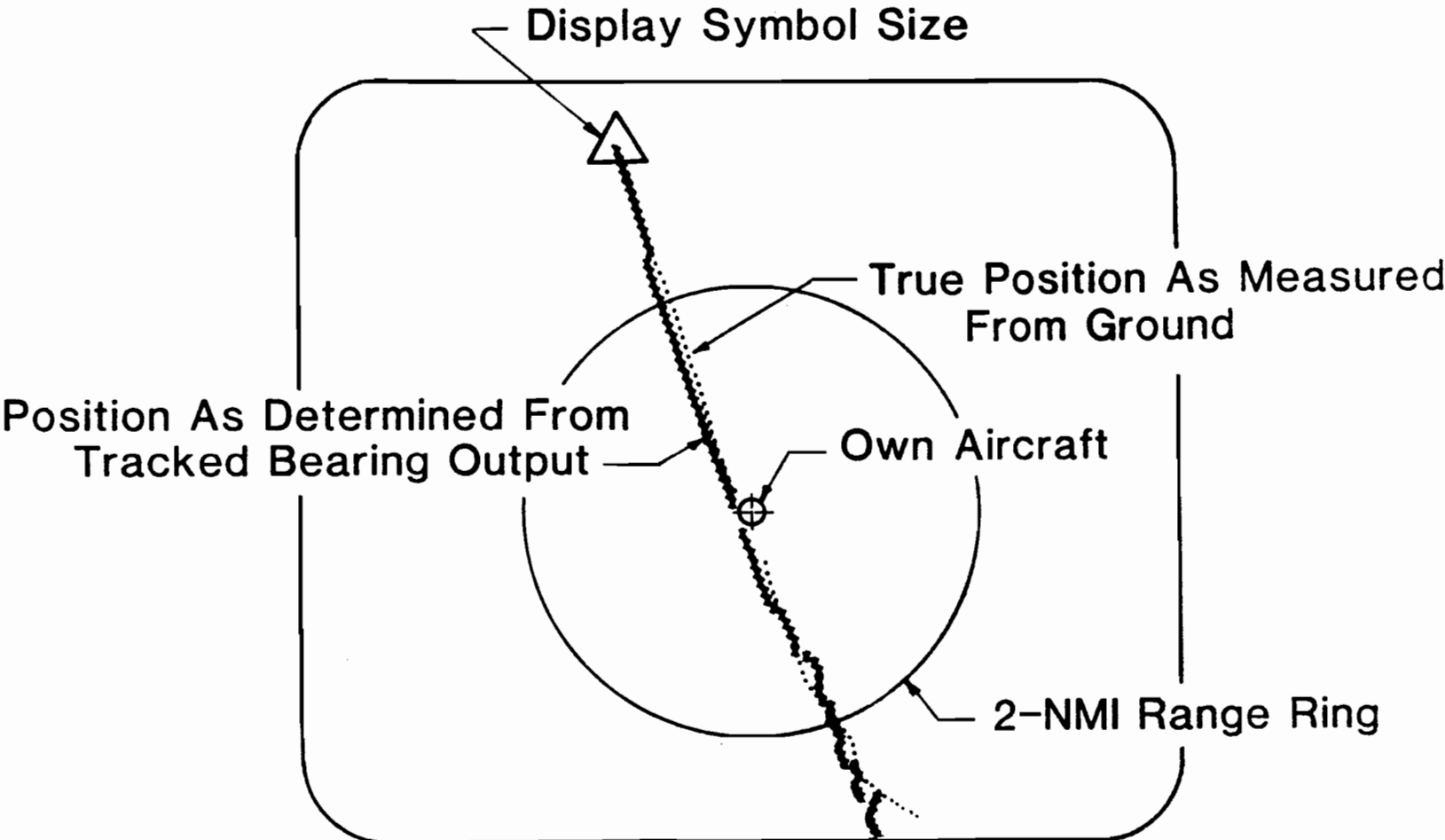

SUMMARY

An airborne collision avoidance unit must detect other aircraft, evaluate collision hazards, determine the proper pilot maneuver, and coordinate with other equipment. Techniques have been described for accomplishing all of these tasks with high reliability for a significant fraction of the aircraft population without requiring special equipment other than standard air traffic control transponders and encoding altimeters on-board the detected aircraft. Although this report has focused on the surveillance task primarily, there has also been significant development activity addressing the remaining tasks [9-11]. Three TCAS Experimental Units have been delivered to the FAA for further evaluation. Preliminary results of these evaluations have been published [12, 13]. These TCAS Experimental units have also been used in an extensive series of TCAS operational evaluation flights using subject pilots in planned encounters to determine the effectiveness of traffic advisories as part of the TCAS operational system.

The design of the TCAS Experimental Units has been duplicated, with certain modifications, by the Dalmo Victor Corp, and repackaged as a pre-production prototype. Two of these commercial units were delivered to the FAA for flight testing and evaluation and subsequently installed for testing on Piedmont Airlines 727 aircraft operating commercially along their normal route structure, which includes most major terminal areas with the exception of California. These were blind tests in which the display data was not visible to the pilot, but most of the encounters were recorded for subsequent analysis. The results show good detection performance and acceptable alarm rates [14]. Recently, one of the Dalmo-Victor units was upgraded to full TCAS II status by the addition of a directional interrogation capability. This unit was flown for several days in the highest-density regions of the Los Angeles Basin airspace along with a TEU that was equipped with a full TCAS II whisper-shout sequence, but which did not include a directional interrogation capability. Both of these equipments demonstrated the capability of TCAS to provide reliable surveillance in densities as high as 0.2 ATCRBS aircraft per nmi². From their performance in those tests it is possible to predict that TCAS will also provide satisfactory surveillance on a population of ATCRBS and Mode S equipped aircraft in the 0.3 aircraft/nmi density anticipated in Los Angeles by the year 2000.

REFERENCES

- [1] V. A. Orlando and J. D. Welch, "Beacon CAS (BCAS) An Integrated Air/Ground Collision Avoidance System", Project Report ATC-62, Lincoln Laboratory, M.I.T. (23 March 1976), FAA-RD-76-2.
- [2] V. A. Orlando, J. D. Welch, W. H. Harman and A. R. Paradis, "TCAS I Design Guidelines", Project Report ATC-114, Lincoln Laboratory, M.I.T. (24 September 1982), FAA-RD-82-12.
- [3] V. A. Orlando, J. D. Welch, "Traffic Alert and Collision Avoidance System (TCAS): A Functional Overview of Active TCAS I", Project Report ATC-118, Lincoln Laboratory, M.I.T. (1 March 1983) DOT/FAA/PM-83/9.
- [4] V. A. Orlando and P. R. Drouilhet, "Mode Select Beacon System Functional Description", Project Report ATC-42C, Lincoln Laboratory, M.I.T. (1 March 1983), DOT/FAA/PM-83/8.
- [5] N. A. Spencer, P. M. Ebert, and L. T. Moses, "Assessment of the Performance of an Active Mode for Beacon Collision Avoidance", The MITRE Corp. (October 1977), FAA-RD-77-151.
- [6] W. H. Harman, "Effects of RF Power Deviations on BCAS Link Reliability", Project Report ATC-76, Laboratory Laboratory, M.I.T. (7 June 1977), FAA-RD-77-78.
- [7] P. H. Mann, "Simulation of Surveillance Processing Algorithm Proposed for the DABS Mode of BCAS", Project Report ATC-82, Lincoln Laboratory, M.I.T. (16 February 1978), FAA-RD-77-138.
- [8] W. P. Niedringhaus, A. D. Zeitlin, "Collision Avoidance Algorithms for Minimum TCAS II," The MITRE Corp., (March 1983), MTR-82W158.
- [9] A. Adkins, B. Billman, R. Strack, J. Windle, "Air Traffic Control/Active Beacon Collision Avoidance System Knoxville Simulation" DOT/FAA Report (May 1980), FAA-RD-80-5.
- [10] T. P. Berry, B. Morgenstern, "An Evaluation of Aircraft Separation Assurance Concepts Using Airline Flight Simulators", ARINC Research Report (November 1979), 1343-01-3-2058.

REFERENCES (Con't)

- [11] L. B. Zarrelli, "Analysis of Active BCAS Alert Rates and Protection Based on Actual Aircraft Tracks," The MITRE Corp., (February 1982), FAA-RD-82-33.
- [12] W. H. Harman, R. R. LaFrey, J. D. Welch, M. L. Wood, "Active BCAS: Design and Validation of the Surveillance Subsystem", Project Report ATC-103, Lincoln Laboratory, M.I.T. (17 December 1980), FAA-RD-80-134.
- [13] R. Tornese, A. L. McFarland, "BCAS Collision Avoidance Logic Performance During Operational Flight Tests", The MITRE Corp. (December 1980), MTR-80W352.
- [14] T. P. Berry, R. D. Brock, "In-Service Evaluation of the Dalmo Victor Active Beacon Collision Avoidance System (BCAS/TCAS)", (October 1982), DOT/FAA/RD-82/90.