

FAA-RD-80-41

**Project Report  
ATC-42  
Revision A**

# **DABS: Functional Description**

**V. A. Orlando  
P. R. Drouilhet**

**11 April 1980**

---

**Lincoln Laboratory**  
MASSACHUSETTS INSTITUTE OF TECHNOLOGY  
*LEXINGTON, MASSACHUSETTS*

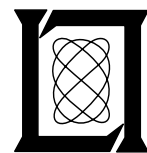

Prepared for the Federal Aviation Administration,  
Washington, D.C. 20591

This document is available to the public through  
the National Technical Information Service,  
Springfield, VA 22161

This document is disseminated under the sponsorship of the Department of Transportation in the interest of information exchange. The United States Government assumes no liability for its contents or use thereof.

1. Report No. FAA-RD-80-41		2. Government Accession No.		3. Recipient's Catalog No.	
4. Title and Subtitle DABS: Functional Description				5. Report Date 11 April 1980	
				6. Performing Organization Code	
7. Author(s) V. A. Orlando, P. R. Drouilhet				8. Performing Organization Report No. ATC-42 Revision A	
9. Performing Organization Name and Address Massachusetts Institute of Technology Lincoln Laboratory P.O. Box 73 Lexington, MA 01173				10. Work Unit No. Proj. No. 052-241-04	
				11. Contract or Grant No. DOT-FA72-WAI-261	
				13. Type of Report and Period Covered Project Report	
12. Sponsoring Agency Name and Address Department of Transportation Federal Aviation Administration Systems Research and Development Service Washington, DC 20591				14. Sponsoring Agency Code	
15. Supplementary Notes The work reported in this document was performed at Lincoln Laboratory, a center for research operated by Massachusetts Institute of Technology under Air Force Contract F19628-80-C-0002.					
16. Abstract  This document provides a functional description of the Discrete Address Beacon System (DABS), a combined secondary surveillance radar (beacon) and ground-air-ground data link system capable of providing the aircraft surveillance and communications necessary to support ATC automation in future traffic environments. DABS is capable of common-channel interoperation with the current ATC beacon system, and may be implemented at low user cost over an extended ATCRBS-to-DABS transition period. In supporting ATC automation, DABS will provide the surveillance and communication performance required by the Automatic Traffic Advisory and Resolution Service (ATARS), the reliable communications needed to support data link services, and the capability of operating with a terminal or enroute, radar digitizer-equipped, ATC surveillance radar.  The material contained in this document updates and expands the information presented in "DABS: A System Description", FAA-RD-74-189, November 1974.					
17. Key Words  Air Traffic Control Surveillance Data Link Data Link Beacon DABS			18. Distribution Statement  Document is available to the public through the National Technical Information Service, Springfield, VA 22151.		
19. Security Classif. (of this report) Unclassified		20. Security Classif. (of this page) Unclassified		21. No. of Pages 104	22. Price

## METRIC CONVERSION FACTORS

### Approximate Conversions to Metric Measures

Symbol	When You Know	Multiply by	To Find	Symbol
<b>LENGTH</b>				
in	inches	*2.5	centimeters	cm
ft	feet	30	centimeters	cm
yd	yards	0.9	meters	m
mi	miles	1.6	kilometers	km
<b>AREA</b>				
in <sup>2</sup>	square inches	6.5	square centimeters	cm <sup>2</sup>
ft <sup>2</sup>	square feet	0.09	square meters	m <sup>2</sup>
yd <sup>2</sup>	square yards	0.8	square meters	m <sup>2</sup>
mi <sup>2</sup>	square miles	2.6	square kilometers	km <sup>2</sup>
	acres	0.4	hectares	ha
<b>MASS (weight)</b>				
oz	ounces	28	grams	g
lb	pounds	0.45	kilograms	kg
	short tons (2000 lb)	0.9	tonnes	t
<b>VOLUME</b>				
tsp	teaspoons	5	milliliters	ml
Tbsp	tablespoons	15	milliliters	ml
fl oz	fluid ounces	30	milliliters	ml
c	cups	0.24	liters	l
pt	pints	0.47	liters	l
qt	quarts	0.95	liters	l
gal	gallons	3.8	liters	l
ft <sup>3</sup>	cubic feet	0.03	cubic meters	m <sup>3</sup>
yd <sup>3</sup>	cubic yards	0.76	cubic meters	m <sup>3</sup>
<b>TEMPERATURE (exact)</b>				
°F	Fahrenheit temperature	5/9 (after subtracting 32)	Celsius temperature	°C

\*1 in = 2.54 (exact). For other exact conversions and more detailed tables, see NBS Misc. Publ. 286, Units of Weights and Measures, Price \$2.25, SO Catalog No. C13.10-286.

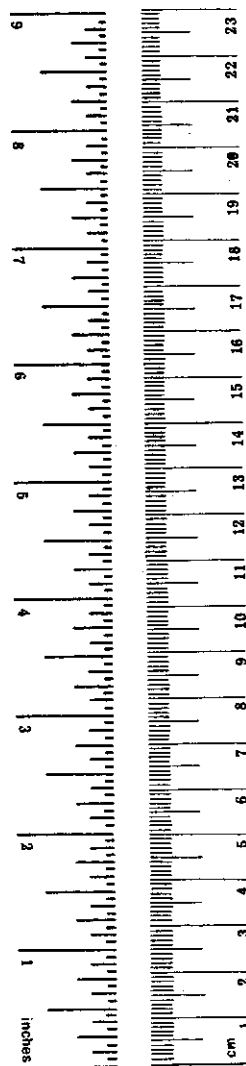

### Approximate Conversions from Metric Measures

Symbol	When You Know	Multiply by	To Find	Symbol
<b>LENGTH</b>				
mm	millimeters	0.04	inches	in
cm	centimeters	0.4	inches	in
m	meters	3.3	feet	ft
m	meters	1.1	yards	yd
km	kilometers	0.6	miles	mi
<b>AREA</b>				
cm <sup>2</sup>	square centimeters	0.16	square inches	in <sup>2</sup>
m <sup>2</sup>	square meters	1.2	square yards	yd <sup>2</sup>
km <sup>2</sup>	square kilometers	0.4	square miles	mi <sup>2</sup>
ha	hectares (10,000 m <sup>2</sup> )	2.5	acres	
<b>MASS (weight)</b>				
g	grams	0.035	ounces	oz
kg	kilograms	2.2	pounds	lb
t	tonnes (1000 kg)	1.1	short tons	
<b>VOLUME</b>				
ml	milliliters	0.03	fluid ounces	fl oz
l	liters	2.1	pints	pt
l	liters	1.06	quarts	qt
l	liters	0.26	gallons	gal
m <sup>3</sup>	cubic meters	35	cubic feet	ft <sup>3</sup>
m <sup>3</sup>	cubic meters	1.3	cubic yards	yd <sup>3</sup>
<b>TEMPERATURE (exact)</b>				
°C	Celsius temperature	9/5 (then add 32)	Fahrenheit temperature	°F

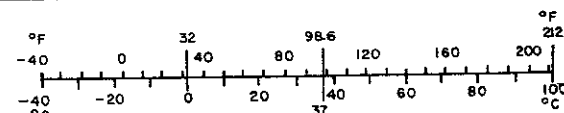

## CONTENTS

CHAPTER 1	OVERVIEW AND SUMMARY	1
CHAPTER 2	THE DABS LINK	13
CHAPTER 3	THE DABS SENSOR	25
CHAPTER 4	THE DABS TRANSPONDER	73
CHAPTER 5	PERFORMANCE	82
REFERENCES		97

## ILLUSTRATIONS

1-1	DABS Elements	3
2-1	ATCRBS/DABS All-Call Interrogation	15
2-2	ATCRBS Reply	16
2-3	DABS Interrogation	17
2-4	DABS Reply	19
2-5	Summary of DABS Uplink Formats	21
2-6	Summary of DABS Downlink Formats	22
2-7	Address/Parity Field Generation	24
3-1	DABS Sensor Functional Block Diagram	26
3-2	ATCRBS/DABS Time Sharing	28
3-3	DABS Roll-Call Scheduling	30
3-4	DABS Cycles	31
3-5	Channel Management	32
3-6	Modulator/Transmitter	35
3-7	Sum and Difference Antenna Patterns	37
3-8	DABS Joint Use Enroute Sensor	39
3-9	Elevation Pattern of a Five Foot Open Array Antenna	41
3-10	Multi-channel Receiver	42
3-11	DABS Reply Processing	43
3-12	ATCRBS Reply Processing	46
3-13	ATCRBS Reply Decoding	47
3-14	Surveillance Processing	50
3-15	DABS Surveillance Processing	51
3-16	ATCRBS Surveillance Processing	53
3-17	Radar Surveillance Processing	55
3-18	Data-Link Processing	57
3-19	Input Message Processing	58
3-20	Output Message Processing	60
3-21	Network Management	61
3-22	Coverage Map Grid Structure	63
3-23	Coverage Coordination	64
3-24	Performance Monitoring	70
3-25	Calibration and Performance Monitoring Equipment (CPME)	72
4-1	Transponder Panel	74
4-2	DABS Transponder	77
4-3	Diversity Transponder	78
4-4	Standard Message Interface Timing Diagram	80

ILLUSTRATIONS (Con't)

5-1	Vertical Lobing	84
5-2	Aircraft Antenna Fading	85
5-3	Miss Probability	87
5-4	DABS Link Reliability for a Terminal Sensor	88
5-5	Noise Induced Monopulse Error	90
5-6	Monopulse Estimate With Interference	92
5-7	Maximum Monopulse Error With Target On Boresight	94
5-8	Capacity Plots	96

TABLES

2-1	DABS Field Descriptions	23
3-1	Control Message Handling	66
5-1	DABS Link Power Budget	83



## CHAPTER 1

### OVERVIEW AND SUMMARY

#### INTRODUCTION

The Discrete Address Beacon System (DABS) is a combined secondary surveillance radar (beacon) and ground-air-ground data link system capable of providing the aircraft surveillance and communications necessary to support ATC automation in the dense traffic environments expected in the future. It is capable of common-channel interoperation with the current ATC beacon system\*, and thus may be implemented at low user cost over an extended ATCRBS-to-DABS transition period. In supporting ATC automation, DABS will provide the surveillance and communication performance required by the Automatic Traffic Advisory and Resolution Service (ATARS), the reliable communications needed to support data link services, and the capability of operating with a terminal or enroute, radar digitizer-equipped, ATC surveillance radar. When operating in conjunction with such a surveillance radar a DABS sensor will use the radar returns either to reinforce beacon tracks, or in cases of transponder failure, to provide tracked radar targets.

The need to support ATARS substantially increases the requirements for ATC surveillance and communication. Today, ATC is primarily concerned with controlled, or IFR, aircraft. ATARS will provide automatic, ground-based, conflict resolution advisories to mode-C equipped VFR and IFR aircraft, and ATC backup separation service to IFR aircraft. To support ATARS, all aircraft in the airspace served, VFR as well as IFR, must be provided with accurate, continuous surveillance, and reliable, minimum delay, digital, communications. In order to meet this requirement at en route facilities, DABS sensors operate with back-to-back beacon antennas to provide twice the beacon data rate available from a standard antenna.

A central DABS design requirement was assurance that the system could be implemented in an evolutionary manner. By the time deployment of DABS begins, approximately 1983, there will be on the order of 200,000 aircraft equipped with ATCRBS transponders, and approximately 500 ground-based interrogators. DABS is designed to operate in this environment, and in a way which will permit the gradual, economic, transition to an all-DABS operation.

The capability for such a transition has been achieved by providing a high degree of compatibility between DABS and ATCRBS. DABS uses the same interrogation and reply frequencies as ATCRBS, and the signal formats have been chosen to permit substantial commonality in hardware. This degree of compatibility permits an economic and smooth transition, in which (a) DABS interrogators will provide surveillance of ATCRBS-equipped aircraft, and (b) DABS transponders will reply to ATCRBS interrogators.

---

\*The Air Traffic Control Radar Beacon System (ATCRBS).

Thus DABS equipment, both on the ground and in aircraft, can be introduced gradually and continue to interoperate with existing systems during an extended transition phase.

### THE DABS CONCEPT

The fundamental difference between DABS and ATCRBS is the manner of addressing aircraft, or selecting which aircraft will respond to an interrogation. In ATCRBS, the selection is spatial, i.e, aircraft within the mainbeam of the interrogator respond. As the beam sweeps around, all angles are interrogated, and all aircraft within line-of-sight of the antenna respond. In DABS, as implied by its name, each aircraft is assigned a unique address code. Selection of which aircraft is to respond to an interrogation is accomplished by including the aircraft's address code in the interrogation. Each such interrogation is thus directed to a particular aircraft. Narrow-beam antennas will continue to be used, but primarily for minimizing interference between sites and as an aid in the determination of aircraft azimuth.

Two major advantages accrue from the use of discrete address for surveillance. First, an interrogator is now able to limit its interrogation to only those targets for which it has surveillance responsibility, rather than to continuously interrogate all targets within line-of-sight. This prevents surveillance system saturation caused by all transponders responding to all interrogators within line-of-sight. Secondly, appropriate timing of interrogations ensures that the responses from aircraft do not overlap, eliminating the mutual interference which results from the overlapping of replies from closely spaced aircraft (so-called synchronous garble).

In addition to the improved surveillance capability, the use of the discrete address in interrogations and replies permits the inclusion of messages to or from a particular aircraft, thereby providing the basis for a ground-air and air-ground digital data link.

### DABS ELEMENTS

As illustrated in Fig. 1-1, DABS is comprised of the sensors, transponders, and the signals-in-space which form the link between them. DABS provides surveillance and ground-air-ground communication service to air traffic control facilities including en route (ARTCC), terminal (TRACON and TRACAB), and the unmanned, sensor based, Automatic Traffic Advisory and Resolution Service (ATARS).

DABS' primary function is to provide these surveillance and communication services in support of air traffic control. However, by proper timing of the interrogations to all DABS-equipped aircraft, suitably equipped aircraft may utilize the DABS replies from other nearby aircraft to perform onboard proximity and conflict detection. This air-to-air mode is termed Synchron-DABS (Ref. 2).

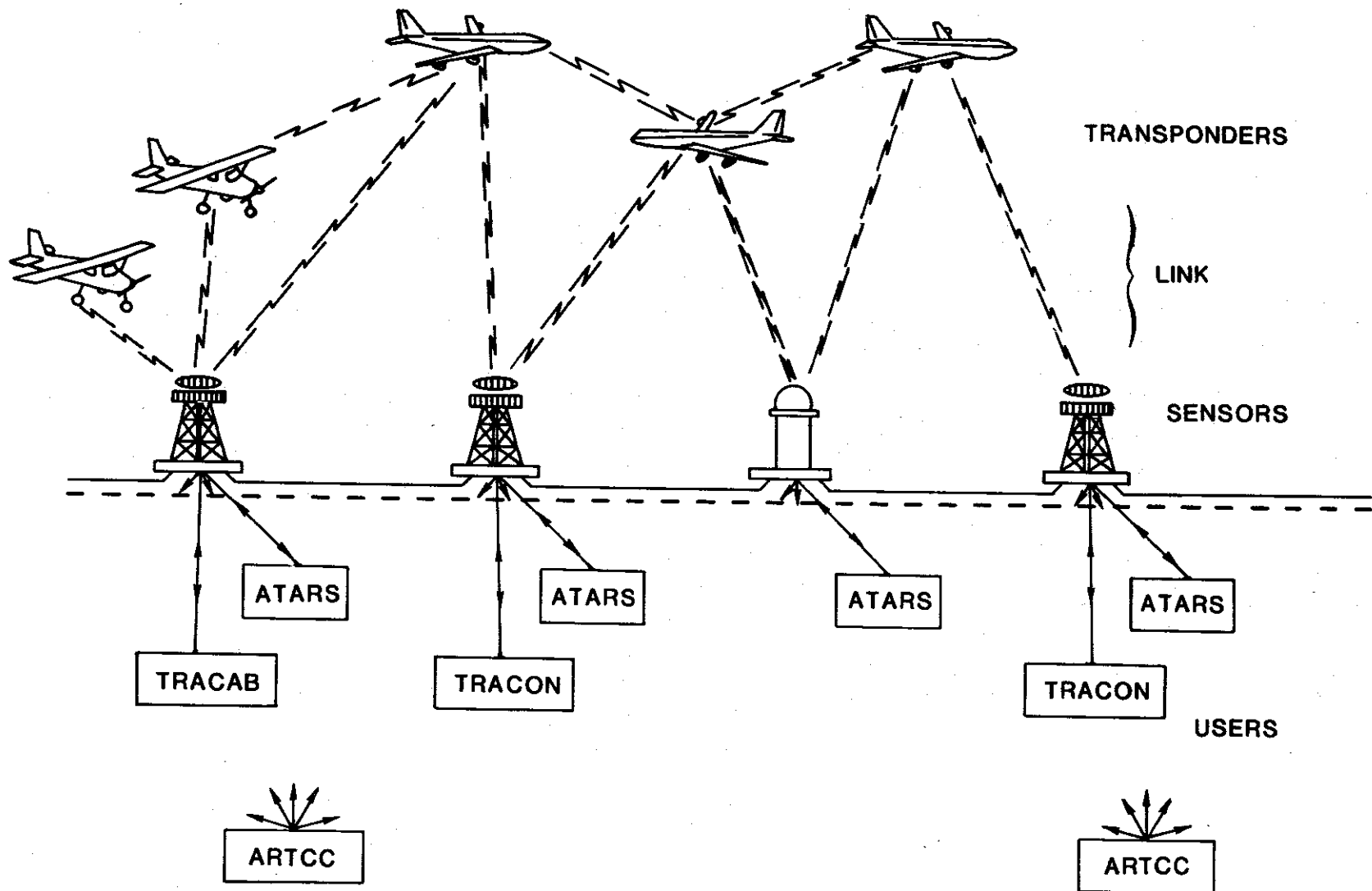

Fig. 1-1. DABS Elements.

The DABS link employs signal formats used for ATCRBS, and adds to these the signal waveforms and message formats necessary to acquire DABS-equipped targets, and for discretely-addressed surveillance and data-link interrogations and replies. The principal characteristics of the DABS signals are as follows:

Interrogation -

Frequency: 1030 MHz  
Modulation: Differential Phase-Shift Keying (DPSK)  
Data Rate: 4 Mbps

Reply -

Frequency: 1090 MHz  
Modulation: Pulse Position (PPM)  
Data Rate: 1 Mbps

Interrogation and Reply -

Data block: 56-bit or 112-bit  
Parity check code (included in data block): 24-bit

A more complete summary of the DABS signal formats is contained in Chapter 2.

The DABS sensor provides surveillance of ATCRBS- and DABS-equipped aircraft, and operates as a store and forward communication relay for data-link communication between aircraft and ATC facilities. In addition, the sensor accepts digitized radar target reports from a collocated radar and combines these with the beacon reports into a composite surveillance output stream. When beacon and radar reports occur on the same target, the radar report is suppressed and the beacon report tagged as radar-reinforced. Radar-only output reports are provided on targets that are not beacon equipped.

To discretely interrogate DABS-equipped aircraft, the sensor maintains a file of the identity and approximate position of all such aircraft within its defined area of coverage.

Each sensor's operation is controlled by a prestored map defining its coverage volume, which may be different in normal operation and in the event of various system failures, e.g., the failure of an adjacent sensor.

In a netted configuration, each sensor may communicate directly with adjacent sensors via ground lines to hand-off targets as they pass from the region of one sensor's coverage to that of an adjacent sensor. In addition, in regions of overlapping coverage, this intersensor communication (in those cases where ground lines are installed) may be used to assist in the reacquisition of a lost target.

In general, each sensor can provide surveillance and communication services to several ATC facilities, i.e., all those whose areas of control responsibility overlap the coverage area of the sensor. The interface between the sensor and each control facility comprises a one-way circuit for the transmission of surveillance data, both radar and beacon, and a two-way circuit for the interchange of data-link messages. The latter is also used to transmit reports of ATARS activity to the ATC facility, and various status and control messages between the sensor and the ATC facility.

The DABS transponder includes all of the functions of an ATCRBS transponder, and adds to these the ability to decode DABS interrogations and to format and transmit the appropriate replies. For data link, the transponder functions primarily as a modem. On receipt of a ground-to-air transmission, it verifies the correctness of the received message using the error-detecting code. Once verified, the transponder transfers the message contents to one or more external devices. For air-to-ground messages, the transponder accepts the message contents from an external input device, and formats and encodes the data for transmission as part of the reply to a subsequent interrogation.

#### DABS SURVEILLANCE

The principal features of DABS surveillance are as follows:

- Unique address
- All-call acquisition
- All-call lockout
- Range-ordered roll-call interrogation
- Adaptive reinterrogation
- Monopulse direction-finding
- Positive handoff
- Multisensor Coverage

Each DABS-equipped aircraft has a permanently assigned unique 24-bit address. This 24-bit address will be included in all discretely-addressed interrogations to that aircraft, and in all DABS replies from that aircraft.

The DABS sensor range-orders interrogations to DABS-equipped aircraft in such a way that the replies do not overlap. The use of monopulse direction finding on the reply permits the sensor to provide surveillance of DABS-equipped aircraft, generally within a single interrogation/reply cycle per rotation (scan) of the interrogator antenna. If a reply to the interrogation is not received, or is received but not successfully decoded, the interrogator has the capability of reinterrogating (several times if necessary) the aircraft during the time the aircraft is in the antenna beam.

In order to be discretely interrogated, an aircraft must be on the sensor's roll-call file, i.e., the sensor must know its address and approximate position. To acquire targets not yet on any sensor's roll-call file,

each sensor transmits all-call interrogations. A DABS-equipped aircraft will respond to such an interrogation with its unique address, and be added to the sensor's roll-call file.

Once on the sensor's roll-call file, the DABS-equipped aircraft may be locked-out from replying to subsequent DABS all-call interrogations. This lockout condition is under positive control of the DABS sensor and is transmitted to the DABS transponder as part of the DABS discrete interrogation. The use of DABS lock-out eliminates unnecessary all-call replies and therefore minimizes interference (particularly all-call synchronous garble) on the air-to-ground channel.

While DABS lock-out can minimize synchronous garble on acquisition, it cannot eliminate it completely nor is it effective in the case where a DABS sensor resumes operation after a period of inactivity and must therefore acquire many DABS aircraft simultaneously. These latter cases are handled by a feature called "the stochastic acquisition mode". In this mode, the DABS sensor interrogates garbling aircraft with a special all-call interrogation that instructs them to reply with a specified less-than-unity reply probability. The resulting reduced reply rate means that some all-call replies will be received ungarbled and these aircraft will thus be acquired. Once an aircraft is acquired it is locked out and hence no longer interferes with the all-call replies from the remaining unacquired aircraft. The process is repeated until all aircraft are acquired.

The use of DABS lockout to minimize interference on all-call replies means that provision must be made to hand off the DABS address to an adjacent site in areas of multisensor coverage. In a netted configuration, DABS aircraft are handed off to an adjacent sensor via direct sensor-to-sensor transmission of the aircraft's address and position. Provision has also been made for the case where DABS sensors have overlapping coverage but do not have ground-to-ground communications links. The principal alternatives are:

Cooperative Unlocking. This alternative requires that each site selectively unlock aircraft at surveillance boundaries in order to allow them to be acquired by the adjacent sensor's normal all-call interrogations.

Site Addressed Lockout. The DABS transponder can be selectively and independently locked out to special all-call interrogations originating from up to 15 different sensor sites. Adjacent sites using different site address numbers are completely unaffected by the other sites' lockout activity and hence can perform acquisition and lockout in a completely autonomous manner.

Lockout Override. A special all-call interrogation can be used that instructs the DABS transponder to ignore any previous lockout instructions. The resulting all-call garble is handled by the stochastic acquisition mode. While offering reduced performance compared to the other alternatives, the approach provides a means for sensors with

overlapping coverage to operate with no site-to-site coordination. Hence it may be useful for operation across national boundaries or for mobile military interrogators.

If for any reason an aircraft ceases to receive discretely-addressed interrogations for a period of approximately 16 seconds (corresponding to a few interrogator scans), any existing lockout will lapse so that the aircraft may be reacquired by normal DABS acquisition.

In regions of airspace visible to more than one DABS sensor, each DABS target will generally be simultaneously on the roll-call of at least two sensors to provide continuity of surveillance and data-link service in the event of a link or sensor failure.

### ATCRBS MODE OF DABS

The DABS sensor provides surveillance of ATCRBS targets with quality better than that of presently operating equipment. This is important because of the high density of ATCRBS-equipped targets which will be experienced during the early years of the ATCRBS-to-DABS transition.

The principal characteristics of ATCRBS surveillance provided by a DABS sensor are:

- Reduced interrogation rate,
- Monopulse direction finding,
- Improved reply degarbling,
- False target identification.

The use of monopulse direction finding on ATCRBS replies permits operation at a reduced ATCRBS interrogation rate, nominally four interrogations in the 3-dB antenna beamwidth. This reduction in ATCRBS interrogation rate causes an immediate and significant reduction in the ATCRBS interference environment at the time when an ATCRBS sensor is replaced by a DABS sensor.

Improved reply processing is used to minimize the effects of mainbeam and sidelobe interference. A major element of this is the use of pulse-by-pulse monopulse data to help decode overlapping replies.

A major current problem in ATCRBS is the appearance of false targets due to reflection from large objects such as buildings, or hillsides. The DABS sensor is programmed to identify and flag such false targets using both target reply parameters (e.g., mode-A code) and the pre-stored geometry of principal reflecting surfaces.

In side-by-side experimental measurements comparing the performance of the ATCRBS mode of DABS with currently operational ATCRBS equipment, it has been shown that the new system provides improvements in range and azimuth accuracies by about 5:1, as well as significant improvement in target report reliability (Ref. 3).

## DABS DATA LINK

DABS provides both ground-to-air and air-to-ground data link capability. Air-to-ground messages may be either pilot-initiated, e.g., a request for a clearance change or for weather information, or ground-initiated, e.g., to read out onboard instrumentation.

The critical nature of many of the messages to be carried by DABS requires a high degree of message integrity; it must be known both at the transponder and at the sensor that a message has been received correctly before the transaction can be considered complete. The required message integrity is ensured by providing for error detection, and technical acknowledgement.

Error-detecting codes are used on both interrogations and replies to essentially eliminate the acceptance of a message containing an error. When the presence of an (uncorrectable)\* error is detected, the whole transmission is rejected. Technical acknowledgment of the correct receipt of an uplink message is achieved by the receipt of a correct reply at the proper time. Technical acknowledgement for a downlink message is provided by an acknowledgment included in a subsequent interrogation. If an error had been detected, no acknowledgment would be received and the message would be repeated.

The three main classes of messages accommodated by DABS are:

- Surveillance data,
- Standard message,
- Extended-length message.

### Surveillance Data

Surveillance data may be included in each normal DABS interrogation and reply (with the exception of the special extended length message and all-call formats). Normally, in a reply this includes an altitude report identical to the ATRBS mode-C report. However, either the ground or the pilot may initiate the inclusion of the ATRBS mode-A code in place of the altitude report, e.g., to indicate an emergency condition. In an interrogation, this may include a command to lockout the transponder to all-call interrogations.

### Standard Message

Most DABS data-link transmissions will be handled as one 56-bit standard message included as part of a 112-bit interrogation or reply; e.g., an ATARS transmission. These transmissions may include surveillance data in addition to the data-link message, and thus will generally be used in place of, rather than in addition to, a surveillance interrogation and/or reply.

\*The sensor can correct certain types of error occurring in replies. Since the transponder has no error-correction capability, an interrogation is only accepted when it is free of error.



In order to prevent interference between DABS replies from different aircraft, the control field of each interrogation specifies the length of the associated reply. Thus when a long reply is needed the interrogator knows in advance and schedules the proper time the reply should be received and allows enough time to receive the long replies. When an aircraft-initiated air-to-ground data-link message is to be sent, a bit is set in the control field of a reply which requests the interrogator to schedule a long reply in response to a subsequent interrogation. The long reply, containing the data-link message, is then transmitted when directed by the interrogator.

#### Extended Length Message

Each standard message must be acknowledged before the transmission of the next one. In order to provide for the more efficient transmission of longer messages, an extended-length message (ELM) capability is incorporated. Using this, a sequence of up to sixteen 80-bit message segments (within 112-bit transmissions) can be transmitted, either ground-to-air or air-to-ground and acknowledged with a single reply or interrogation. This acknowledgment indicates which, if any, of the message segments were not received (or received in error), so that only those need be retransmitted.

Extended-length messages do not contain the surveillance data and thus cannot substitute for a surveillance interrogation and/or reply. As in the case of the air-to-ground standard message, the transponder must request permission to transmit an air-to-ground ELM, and then does so under interrogator control.

#### Multisite Operation

The data link protocol for the standard ground-to-air message operates correctly in areas of overlapping sensor coverage without any requirements for site-to-site coordination. This permits the autonomous delivery of time-critical tactical messages under any circumstances. The other protocols, e.g., the air-to-ground standard and the extended length messages, require that only one sensor at a time exercise these protocols for a particular aircraft in order to avoid message loss or error.

#### SURVEILLANCE MANAGEMENT

DABS limits its surveillance to targets of interest, i.e., to those within a defined coverage volume. This contrasts with ATCRBS in which all targets within line-of-sight are interrogated. Control of the DABS sensor's surveillance and communications functions is based upon a prestored map which defines the action of the sensor for the regions of airspace within its visibility.

For an isolated sensor (one for which there are no other DABS sensors with continuous or overlapping coverage), the surveillance management functions are quite simple. They consist of defining the regions of airspace in which:

- (a) the sensor provides surveillance and data-link service, and
- (b) the sensor locks out DABS-equipped aircraft from responding to all-call interrogations.

As DABS sensors become deployed, multiple coverage will exist at higher altitudes. DABS includes a network management function to control the operation of the DABS sensors in this environment. Adjacent sensors will normally be netted and hence will communicate directly with each other, both to handoff targets as they cross surveillance boundaries, and to assist one another in maintaining continuity of surveillance and data-link service. Non-netted sensors will coordinate their surveillance activities using one of the alternatives previously described. Data link coordination is effected through the use of multisite coordination features incorporated in the DABS transponder.

As in the isolated sensor case, the basis for network management is a map prestored at each sensor which defines its responsibilities for targets in each region of airspace. Not only does this map define the actions of the sensor itself, it also designates which adjacent sensors provide coverage of the same region of airspace and defines the location of coverage boundaries. Netted sensors refer to this map to determine which adjacent sensor can give it assistance in maintaining track on a given target, and when a sensor should initiate a handoff of the target to another sensor. Non-netted sensors use the map to determine when to use the transponder multisite coordination features for downlink or ELM transactions as well as to determine when to initiate periodic DABS unlocking to enable acquisition by an adjacent sensor.

Multiple sensor coverage is exploited in DABS to assure a continuity of both surveillance and data-link service. Where such multiple coverage is available, a target is always maintained simultaneously on roll-call of at least two sensors, thereby providing instantaneous backup in the event of the failure of one sensor/aircraft link. If for some reason a netted sensor loses contact with an aircraft, it calls on the adjacent tracking sensor for assistance in reacquiring the target.

In order to preclude possible ambiguities which can occur when two sensors simultaneously have an aircraft on their roll, a single sensor is normally designated primary in each region of airspace. The special functions which are the responsibility of the primary sensor are:

- (a) readout of air-to-ground data-link messages,
- (b) synchronous interrogation,
- (c) lockout to DABS all-calls,
- (d) ELM transactions.

The determination of which DABS sensor is to act as primary for a particular aircraft is made by the air traffic control facility which has control responsibility for the aircraft. This is done to ensure that air initiated data link messages are read out by the sensor connected to the controlling ATC facility. For uncontrolled aircraft, the DABS sensors make the assignment themselves, based on coverage map information.

## DABS/ATC INTERFACE

The DABS/ATC interface is particularly simple in the case of an isolated DABS sensor interacting with a single control facility, e.g., a sensor at an airport interconnected only with the local TRACON. In this situation the sensor provides surveillance data to the TRACON, and operates as a relay point for data-link messages between aircraft and ATC.

In general, however, each sensor is capable of providing surveillance and communication service for more than one facility, and in turn each control facility may receive data from more than one sensor. This capability of greater connectivity permits control facilities to take advantage of multiple coverage to maintain surveillance and data-link service in the event of an equipment or link failure at a particular sensor. Surveillance boundaries between adjacent sensors are determined primarily by coverage geometry; these will not be the same as the control boundaries between adjacent ATC facilities, which are determined by air traffic flow patterns.

In general, a control facility will use the data from only one sensor to maintain its track on a particular aircraft. For an en route facility, data on the same aircraft may be available from another sensor as an instantaneous backup. Typically the data from the sensor designated as primary would be used, as presumably this sensor would have best coverage in a particular region of airspace. The control facility may use any sensor which has an aircraft in its track file for the transmission of standard ground-to-air data-link messages to that aircraft. In the case of a particularly urgent message, more than one sensor can be used simultaneously for ground-to-air message delivery to minimize the possibility of any delay in its reception.

## OTHER INTERFACES

The DABS sensor will interface with other external devices and facilities. These include:

Data Link. In general, the data link processes will use the DABS sensor as a communications modem and will therefore use the same communications interface employed by the ATC facilities.

MTD/SRAP. Digitized radar data will be input to the DABS sensor via a special input port designated for this purpose. Provision is made to interface with either the Moving Target Detector (MTD) or the Sensor Receiver and Processor (SRAP).

Military Air Defense Command. A special configuration of back-to-back DABS sensor will operate at joint use sites. This configuration will include interfaces to military equipment to permit the coordination of beacon surveillance and secure IFF modes of operation. A special surveillance output interface is included to provide the military ATC facility with data in the proper format.

## SYSTEM PERFORMANCE SUMMARY

### Surveillance -

Capacity	- 250, 400 or 700 aircraft per sensor
Sigma-azimuth	- 0.06 deg., $\pm 0.033^\circ$ bias
Sigma-range	- 50 feet, $\pm 150$ feet bias
Data update interval	- 4 seconds (terminal sensor beacon data)
	- 5 seconds (enroute sensor)
	- 10 seconds(en route sensor primary radar data)

### Data Link -

Capacity	All identified ATC messages require a few percent of available capacity.
Delivery Reliability	> 0.99 in 4 seconds for short tactical messages
Undetected error rate	< $10^{-7}$

### System Reliability -

Multiple coverage.  
Automatic monitoring and network reconfiguration.  
Automatic substitution of redundant sensor components without loss of database in case of failure.  
Remote maintenance monitor.

The available interrogation time is sufficient to permit a sensor to maintain discrete-address surveillance of more than 1000 aircraft. This is considerably in excess of the maximum expected target load. A typical sensor would be sized with the processing capability or track file storage to accommodate a much smaller number, e.g., 400 targets.

The achievable range measurement accuracy is dominated primarily by transponder turn-around time uncertainty.

## CHAPTER 2

### THE DABS LINK

#### SIGNAL WAVEFORMS

There are five signal types used by DABS for surveillance of ATCRBS-and DABS-equipped aircraft, and data-link communication with DABS-equipped aircraft. These are:

- (a) The ATCRBS/DABS all-call interrogation, used for surveillance of ATCRBS-equipped aircraft and acquisition of DABS-equipped aircraft not already on a sensor's roll-call.
- (b) The ATCRBS-only all-call interrogation, used for surveillance of ATCRBS equipped aircraft in conjunction with the DABS-only all-call. It does not elicit a response from DABS equipped aircraft.
- (c) The ATCRBS reply, used by ATCRBS transponders in replying to ATCRBS and ATCRBS/DABS all-call interrogations and by DABS transponders in replying to ATCRBS interrogators.
- (d) The DABS interrogation, used for roll-call surveillance and data-link communication to DABS-equipped aircraft. It is also used for the DABS-only all-call interrogation format needed for the stochastic acquisition mode, site addressed lockout and lockout override functions.
- (e) The DABS reply, used by DABS transponders in response to DABS interrogations and ATCRBS/DABS all-call interrogations and DABS-only all-call interrogations.

To maximize hardware compatibility between DABS and ATCRBS, DABS interrogations and replies use the same frequencies as are used for ATCRBS interrogations and replies, i.e., 1030 and 1090 MHz, respectively.

The characteristics of these signal types are summarized in the following paragraphs, together with the most common DABS data block formats. A more detailed description of the DABS interrogations and replies is presented in the DABS National Standard.

#### ATCRBS/DABS and ATCRBS-Only All-Call Interrogations

The ATCRBS/DABS and ATCRBS-only all-call interrogations are similar to the corresponding ATCRBS interrogations as defined in the United States National Standard for ATCRBS (Ref. 5) but with an additional pulse P4 following P3

(Fig. 2-1). A P-4 pulse width of 1.6  $\mu$ sec defines the ATCRBS/DABS all-call interrogation, while a P-4 pulse width of 0.8  $\mu$ sec defines the ATCRBS-only all-call interrogation.

An ATCRBS transponder is unaffected by the presence of the P4 pulse. It will respond with a normal ATCRBS reply. A DABS transponder will recognize the interrogation as a DABS all-call or ATCRBS-only all-call and transmit a DABS reply containing its discrete address to the former and not respond to the latter.

As in ATCRBS, DABS interrogator sidelobe suppression (SLS or ISLS) is accomplished by the transmission of a control pulse P2 on an SLS control pattern (usually omni-directional in azimuth). If this pulse is received by either an ATCRBS or DABS transponder at an amplitude exceeding that of the P1 pulse of the interrogation, the transponder will not reply.

#### ATCRBS Reply

The ATCRBS reply signal characteristics are as defined in the United States National Standard for ATCRBS. The signal format is depicted in Fig. 2.2.

#### DABS Interrogation

The DABS interrogation is formed by three pulses, P<sub>1</sub>, P<sub>2</sub> and P<sub>6</sub> as illustrated in Fig. 2-3.

Pulses P<sub>1</sub> and P<sub>2</sub> form the preamble and are spaced 2  $\mu$ s apart. An ATCRBS transponder which receives this interrogation will interpret the pair as an ATCRBS sidelobe suppression command and will remain in suppression ( $35 \pm 10 \mu$ sec) during the remainder of the DABS interrogation. Without such suppression, the subsequent DABS P<sub>6</sub> pulse would, with high probability, trigger the ATCRBS transponder, causing a spurious reply.

The P<sub>6</sub> pulse of the DABS interrogation is either 16.25 or 30.25  $\mu$ s long and contains the data in the form of DPSK (Differential Phase Shift Keying) modulation at a 4 Mbps rate. A phase reversal of the rf carrier at the beginning of a bit interval represents a binary one while the absence of such reversal denotes a binary zero.

The 4 Mbps rate permits transmission of 112-bit messages within the minimum available ATCRBS suppression interval. DPSK provides superior interference immunity, increased fade margin, and greater multipath immunity than pulse amplitude modulation (PAM). These advantages are realized at a small increment in transponder cost.

Transmit sidelobe suppression is accomplished by the transmission of a control pulse (P5) on an SLS control pattern. If the control pulse amplitude received by the transponder exceeds the amplitude of the interrogation, the sync phase reversal will be obscured and the interrogation will be rejected. With discrete address interrogations, transmit SLS is not required to prevent

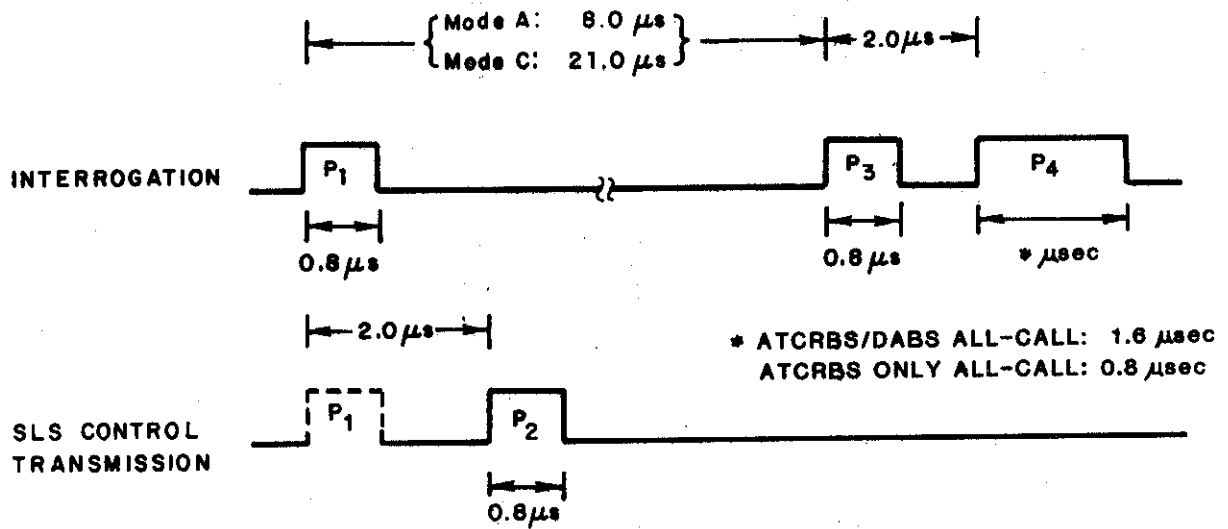

Fig. 2-1. ATCRBS/DABS All-Call Interrogation.

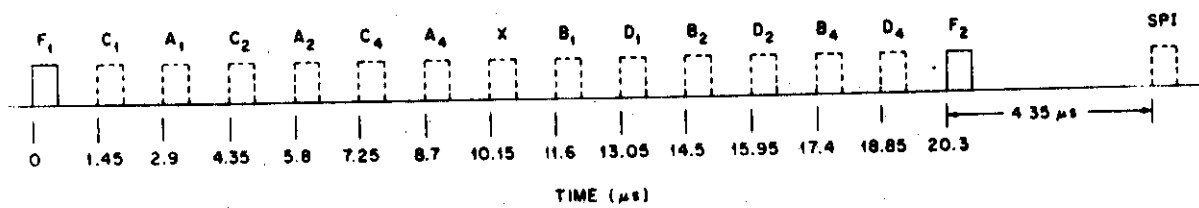

Fig. 2-2. ATCRBS Reply.



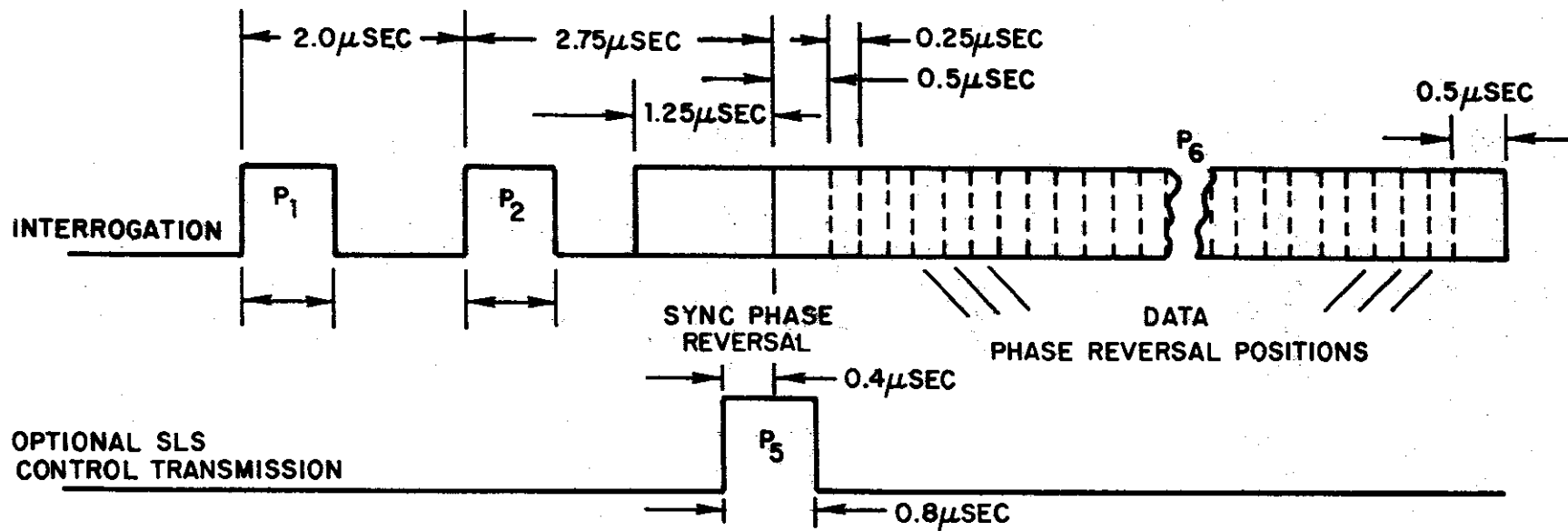

Fig. 2-3. DABS Interrogation.

sidelobe replies, as in general an aircraft will be interrogated only when in the mainbeam of the interrogator antenna. However, transmit SLS on discretely-addressed interrogations minimizes the probability of an aircraft erroneously accepting an interrogation directed to another aircraft; most such interrogations will be received through an interrogator antenna sidelobe, and thus will be rejected by the transponder without decoding.

### DABS Reply Waveform

A DABS reply consists of a preamble and a data block containing 56 or 112 pulses. The signal format is depicted in Fig. 2-4.

The preamble consists of a series of four 0.5  $\mu$ s pulses. The data block begins 8.0  $\mu$ s after the leading edge of the first preamble pulse. Binary data are transmitted at a 1 Mbps data rate using pulse position modulation (PPM) as follows: in the 1.0  $\mu$ s interval corresponding to each data bit, a 0.5  $\mu$ s pulse is transmitted in the first half of the interval if the data bit is a 1, and in the second half of the interval if the data bit is a 0.

Transponder cost considerations limited the choice of reply signal formats to ones which could be generated by the proven, low-cost, pulsed-cavity oscillator transmitters currently used in ATCRBS transponders. Within that constraint, the reply format has been designed to achieve reliable air-to-ground operation in the presence of heavy ATCRBS interference.

The four-pulse preamble is designed to be easily distinguished from ATCRBS replies. It can be reliably recognized and used as a source of reply timing in the presence of one overlapping ATCRBS reply, while at the same time resulting in a low rate of false alarms arising from multiple ATCRBS replies.

The choice of PPM for the data modulation permits reliable bit detection in the presence of ATCRBS interference. In addition, PPM results in a constant number of pulses in each reply, assuring sufficient energy for an accurate monopulse estimate.

Operation at 1 Mbps, in combination with the use of the 24-bit parity check coding described below, further enhances downlink reliability by permitting the correction of any error pattern which can result from a single ATCRBS reply interfering with the desired DABS reply.

### DABS SIGNAL CONTENT

The information transmitted in DABS interrogations and replies is contained in data blocks which can carry either 56 or 112 bits of information. The interrogation data block is formed by the sequence of (DPSK) phase reversals within  $P_6$ , while the reply data block is represented by the pulse position modulation of the DABS reply waveform.

Information within each data block is encoded in fields, each field existing for a dedicated purpose. All data blocks contain at least two essential fields, the format descriptor and the address/parity field. The

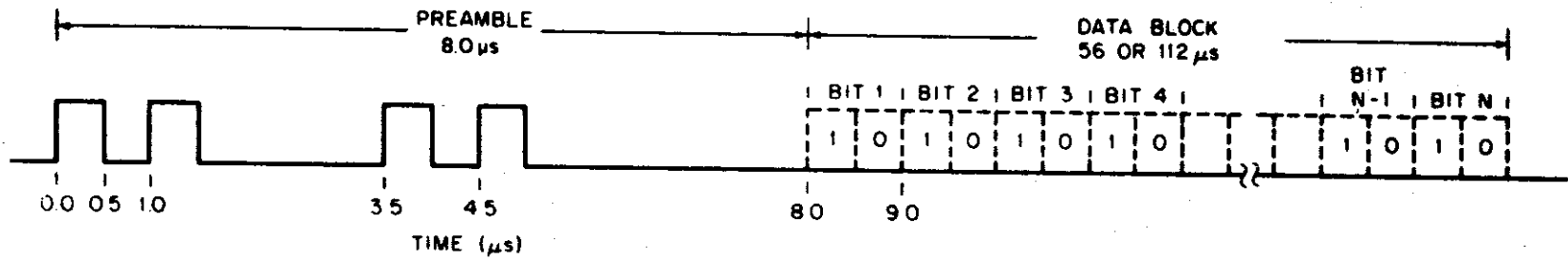

Fig. 2-4. DABS Reply.

5-bit format descriptor is transmitted at the beginning of each data block while the address/parity field is transmitted at the end. For different purposes and missions of the DABS system, 25 different formats can be used; 12 are presently defined. Format information is summarized in figs. 2-5 and 2-6 as well as Table 2-1. For details see the DABS National Standard.

The 24-bit address/parity field contains the aircraft's 24-bit unique address code overlaid on (summed bit-by-bit modulo 2 with) 24 parity check bits generated on the preceding part of the transmission, as illustrated in Fig. 2-7.

An error occurring anywhere in the reception of an interrogation or a reply will modify the decoded address. On the uplink, the transponder will not accept the message and will not reply, as the interrogation does not appear to be addressed to it. On the downlink, the interrogator will recognize that an error has occurred, since the reply does not contain the expected address. Because the interrogator knows the address of the transponder replying to a discrete interrogation, the interrogator can perform a limited amount of error-correction. The code parameters have been selected to permit the correction of many error patterns which span no more than 24 bits. In particular, most bursts of errors caused by interference from a simultaneously-received ATCRBS reply can be corrected.

Format	
No.	
0	<u>UF</u> (0 0000)(AQ:1)( BI:26 )(AP:24) . . . . Short Special Surveillance
1	(0 0001)-----27------(AP:24)
2	(0 0010)(EP:8)-----19------(AP:24) . . . . Short Synchr. Surveillance
3	(0 0011)-----27------(AP:24)
4	(0 0100)(PC:3)(RR:5)(DI:3)(SD:16)(AP:24) . . . . Surveillance, Altitude
5	(0 0101)(PC:3)(RR:5)(DI:3)(SD:16)(AP:24) . . . . Surveillance, Identity
6	(0 0110)-----27------(AP:24) . . . . Ground-Air Coordination
7	(0 0111)-----27------(AP:24)
8	(0 1000)-----27------(AP:24)
9	(0 1001)-----27------(AP:24)
10	(0 1010)-----27------(AP:24)
11	(0 1011)(PR:4)(II:4)(--19 one's--)(AP:24) . . . . DABS-Only All-Call
12	(0 1100)-----27------(AP:24)
13	(0 1101)-----27------(AP:24)
14	(0 1110)-----27------(AP:24)
15	(0 1111)-----27------(AP:24)
16	(1 0000)(AQ:1)( BI:26 )(MU:56)(AP:24) . Long Special Surveillance
17	(1 0001)-----83------(AP:24)
18	(1 0010)(EP:8)-----19------(MS:56)(AP:24) . Long Synchr. Surveillance
19	(1 0011)-----83------(AP:24)
20	(1 0100)(PC:3)(RR:5)(DI:3)(SD:16)(MA:56)(AP:24) . Comm-A, Altitude
21	(1 0101)(PC:3)(RR:5)(DI:3)(SD:16)(MA:56)(AP:24) . Comm-A, Identity
22	(1 0110)-----83------(AP:24) . Ground-Air Coordination
23	(1 0111)-----83------(AP:24)
24	(11)(RC:2)(NC:4)( MC:80 )(AP:24) . Comm-C (ELM)

Notes: (1) (XX:M) denotes a field designated "XX" which is assigned M bits,  
(2) ---N--- denotes free coding space with N available bits,  
(3) UF (Uplink Format) codes 24 through 31 are reserved for Comm-C transmissions. The leading bits of these codes are always "11"; the remaining bits vary with the content of the RC and NC fields.

Fig. 2-5. Summary of DABS Uplink Formats.

Format

DF No.		
0	(0 0000) (AQ:1) (BR:13) (AC:13) (AP:24)	. . . . . Short Special Surveillance
1	(0 0001)-----27----- (AP:24)	
2	(0 0010) (EP:8)-----6----- (AC:13) (AP:24)	. . . . . Short Synchr. Surveillance
3	(0 0011)-----27----- (AP:24)	
4	(0 0100) (FS:3) (DR:5) (UM:6) (AC:13) (AP:24)	. . . . . Surveillance, Altitude
5	(0 0101) (FS:3) (DR:5) (UM:6) (ID:13) (AP:24)	. . . . . Surveillance, Identity
6	(0 0110)-----27----- (AP:24)	. . . . . Not Used
7	(0 0111)-----27----- (AP:24)	
8	(0 1000)-----27----- (AP:24)	
9	(0 1001)-----27----- (AP:24)	
10	(0 1010)-----27----- (AP:24)	
11	(0 1011) (CA:3) (AA:24) (PI:24)	. . . . . All-Call Reply
12	(0 1100)-----27----- (AP:24)	
13	(0 1101)-----27----- (AP:24)	
14	(0 1110)-----27----- (AP:24)	
15	(0 1111)-----27----- (AP:24)	
16	(1 0000) (AQ:1) (BR:13) (AC:13) (SC:56) (AP:24)	. . Long Special Surveillance
17	(1 0001)-----83----- (AP:24)	
18	(1 0010) (EP:8)-----6----- (AC:13) (MT:56) (AP:24)	. . Long Synchr. Surveillance
19	(1 0011)-----83----- (AP:24)	
20	(1 0100) (FS:3) (DR:5) (UM:6) (AC:13) (MB:56) (AP:24)	. . Comm-B, Altitude
21	(1 0101) (FS:3) (DR:5) (UM:6) (ID:13) (MB:56) (AP:24)	. . Comm-B, Identity
22	(1 0110)-----83----- (AP:24)	. . Not Used
23	(1 0111)-----83----- (AP:24)	
24	(11)---1--- (KE:1) (ND:4) (MD:80) (AP:24)	. . Comm-D (ELM)

Notes: (1) (XX:M) denotes a field designated "XX" which is assigned M bits,  
 (2) ---N--- denotes free coding space with N available bits,  
 (3) DF (Downlink Format) codes 24 through 31 are reserved for Comm-D transmissions. The leading bits of these codes are always "11"; the remaining bits vary with the content of the KE and ND fields.

Fig. 2-6. Summary of DABS Downlink Formats.

TABLE 2-1

DABS FIELD DESCRIPTIONS

<u>Code</u>	<u>Field Name</u>	<u>Downlink (D)/Uplink (U) Meaning</u>
AA	Address Announced	D Aircrf. identification in All-Call reply
AC	Altitude Code	D equivalent to aircraft Mode-C code
AP	Address/Parity	U/D error detection field
AQ	Acquisition	U/D part of BCAS protocol
BR	BCAS Reply Data	D special data for BCAS
CA	Capability	D aircraft report of system capability
DF	Downlink Format	D downlink descriptor
DI	Data Identification	U describes content of SD field
DR	Downlink Request	D aircraft requests permission to send data
EP	Epoch	U/D synchro-DABS time indicator
FS	Flight Status	D aircraft's situation report
ID	Identification	D equivalent to ATCRBS identity number
II	Interrogator Identification	U site number for multisite features
KE	Control, ELM	D part of Extended Length Message protocol
MA	Message, Comm-A	U message to aircraft
MB	Message, Comm-B	D message from aircraft
MC	Message, Comm-C	U long message segment to aircraft
MD	Message, Comm-D	D long message segment from aircraft
MS	Message, Synchro-DABS	D uplink synchro DABS message
MT	Message, Synchro-DABS	D downlink synchro DABS message
MU	Message, Uplink	U message without surveillance function
MS	Message, Synchro-DABS	D uplink synchro DABS message
MT	Message, Synchro-DABS	D downlink synchro DABS message
MU	Message, Uplink	U message without surveillance function (BCAS etc.)
NC	Number, C-segment	U part of ELM protocol
ND	Number, D-segment	D part of ELM protocol
PC	Protocol	U operating commands for the transponder
PI	Parity/Interr. Identifier	D reports source of interrogation
PR	Probability of Reply	U used in stochastic acquisition mode
RC	Reply Control	U part of ELM protocol
RR	Reply Request	U commands details of reply
SC	Special Communication	D BCAS report
SD	Special Designator	U control codes to transponder
UF	Uplink Format	U format descriptor
UM	Utility Message	D short message from aircraft

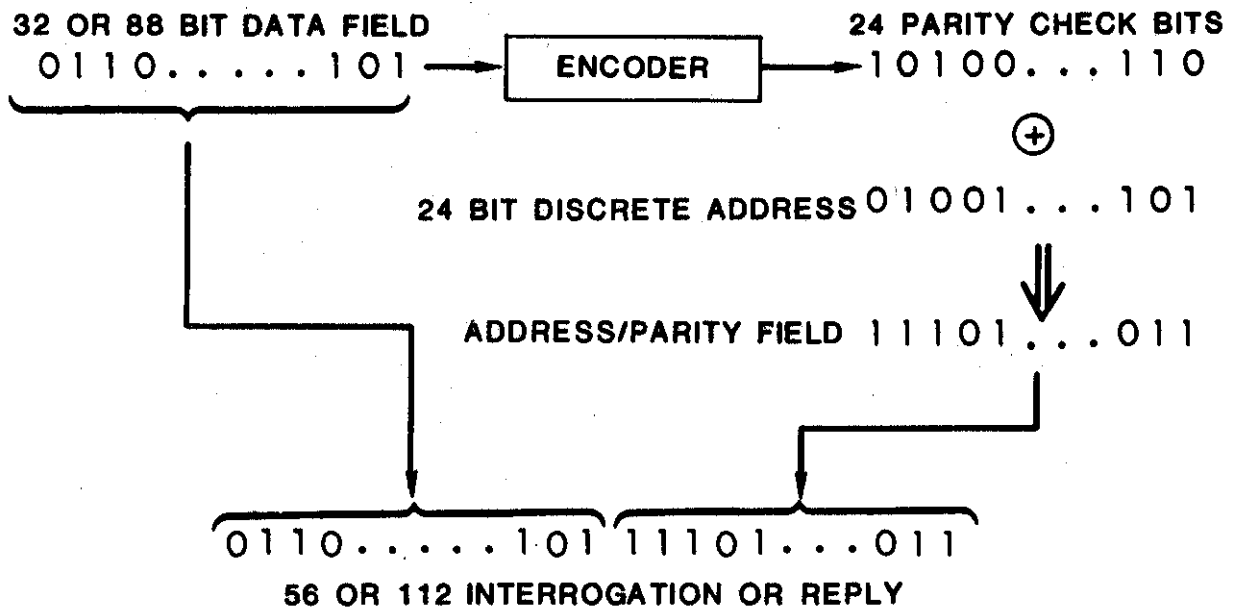

Fig. 2-7. Address/Parity Field Generation.



## CHAPTER 3

### THE DABS SENSOR

The DABS sensor performs surveillance of DABS- and ATRCBS-equipped aircraft within its assigned area of coverage, and acts as a communication relay for data-link messages between DABS-equipped aircraft and air traffic control facilities. In addition, the sensor accepts digital target reports from a collocated radar, and merges these into a common surveillance output stream, correlating the radar and beacon reports when both exist on the same target.

Each sensor includes an Automatic Traffic Advisory and Resolution Service (ATARS) which provides conflict detection and resolution service to DABS-equipped aircraft.

The sensor interfaces with the airborne transponders via the RF link, and (when netted) with adjacent sensors and ATC facilities via low-baud-rate digital communication circuits.

The functional architecture of the sensor is illustrated in Fig. 3-1. Most sensor functions are conveniently categorized according to the time scale on which they operate, as follows:

- (a) Those which involve the generation and processing of signals, and therefore operate on a microsecond time scale; e.g.:

- modulator/transmitter
- multichannel receiver
- DABS and ATRCBS reply processors

- (b) Those which involve channel transactions, and operate at a millisecond time scale, commensurate with the dwell time of the interrogator antenna on a target; e.g.: channel management and ATRCBS reply correlation

- (c) Those which are paced by the antenna scan time, and therefore operate on a time scale the order of a second; e.g.:

- surveillance processing
- data-link processing
- network management
- performance monitoring
- ATARS

Two additional functional elements, which do not fall into the above categories, are the antenna system and the clock.

The remainder of this chapter describes each of these functions in turn, and their major interactions. Because of its central importance to overall sensor operation, channel management is considered first, followed by those

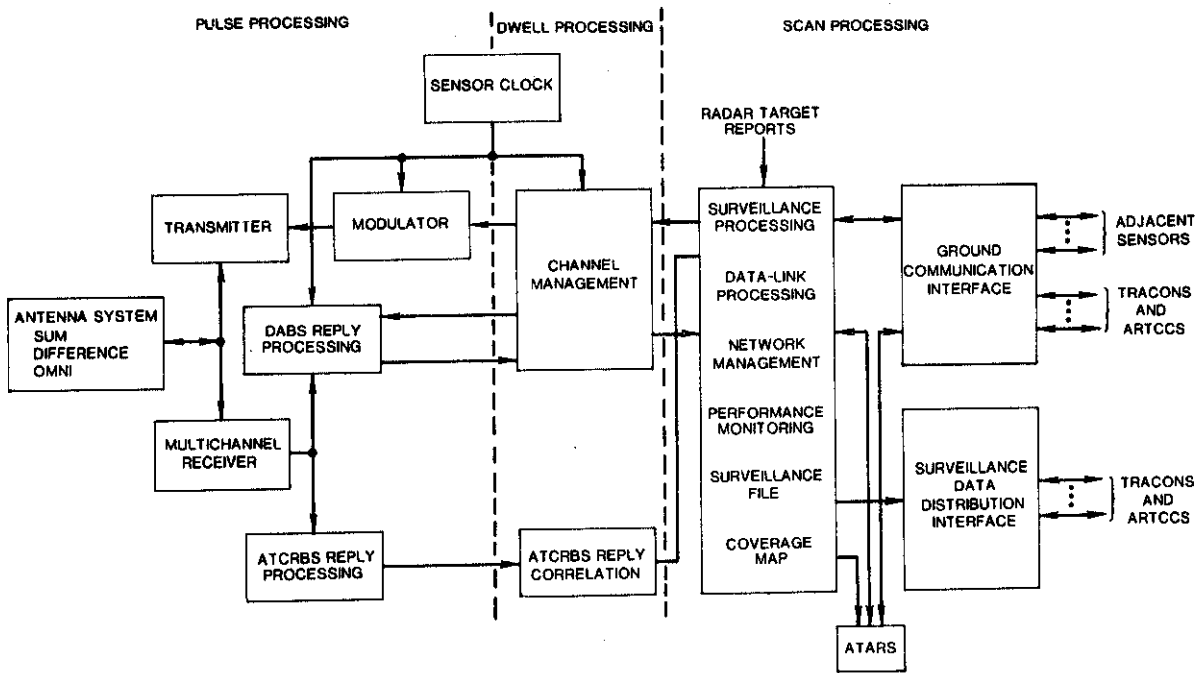

Fig. 3-1. DABS Sensor Functional Block Diagram.

functions responsible for the generation and processing of channel signals, and finally those involved in surveillance and data-link message distribution and multisensor network coordination.

### CHANNEL MANAGEMENT

Channel management regulates all activity on the RF channel through control of the modulator/transmitter and the ATCRBS and DABS reply processors. Its principal function is the scheduling of ATCRBS and DABS interrogations.

When configured for back-to-back antenna operation, channel management separately schedules interrogations for each antenna face, and controls switching between the faces.

To provide surveillance of both ATCRBS- and DABS-equipped aircraft with minimal mutual interference, the RF channel is time-shared between the ATCRBS (and DABS all-call) modes and the DABS mode as illustrated in Fig. 3-2.

### ATCRBS Scheduling

ATCRBS interrogations are scheduled at the beginning of an ATCRBS period as determined by a site adaption input that defines the sensor time line. To reduce the incidence of fruit and second-time-around target reports, these interrogations can be pseudo-randomly jittered from the nominal interrogation time.

In any of the above modes, a range of ATCRBS interrogation rates can be accommodated. In order to provide a maximum of channel time for DABS activity, the sensor has been designed for a nominal ATCRBS rate of two interrogations per mode, e.g., A,C,A,C per beam dwell.

Following each ATCRBS interrogation, the sensor processes ATCRBS replies for an interval corresponding to the maximum desired coverage range at the current antenna azimuth. When the desired coverage range is short, initiation of the subsequent DABS interval may be delayed to allow replies from longer-range ATCRBS targets to "ring out" so that they do not interfere with DABS replies.

### DABS Scheduling

Scheduling of DABS interrogations and replies operates under the following principal ground rules:

- (a) DABS interrogations are addressed only to aircraft within the antenna beam.
- (b) Channel time is allocated to each DABS interrogation and reply based upon a prediction of aircraft range.
- (c) DABS surveillance and data-link procedures may require more than one interrogation to each aircraft. Therefore, the sensor is able to reinterrogate an aircraft while it remains in the beam.

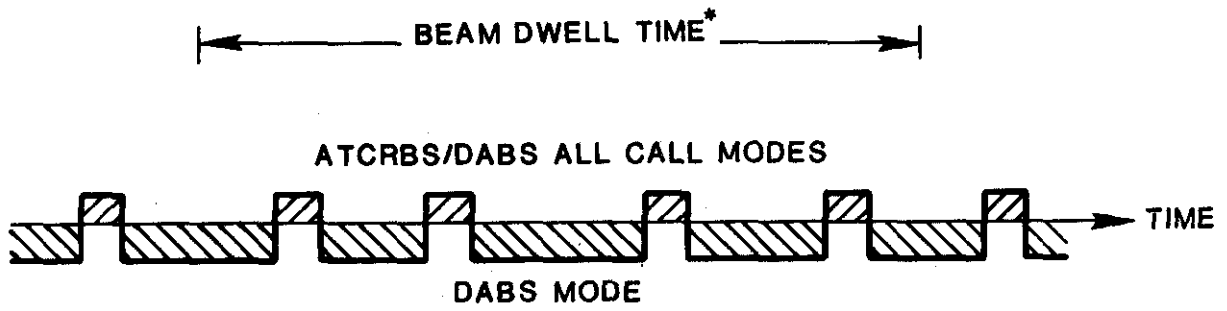

**\* TYPICALLY 25-30 MS FOR A TERMINAL SENSOR**

Fig. 3-2. ATCRBS/DABS Time Sharing.

The sensor maintains an active target list, comprising those DABS targets that are within the antenna beam, and makes repeated passes through this list, scheduling discretely-addressed DABS interrogations and replies on a nonconflicting basis. A single aircraft may appear on one or more of the resulting schedules of interrogations and replies, so that multiple surveillance and communication tasks can be accomplished. In the case of a failure to receive a reply, the capability for repeated scheduling of interrogations to an aircraft provides a high overall surveillance/ communication reliability.

The principal elements of DABS roll-call scheduling are illustrated in Fig. 3-3. The intervals of time devoted to DABS roll-call activity are called DABS periods. During a DABS period, one or more roll-call schedules are produced. A schedule is a set of interrogation and reply times which allows the sensor to carry out one transaction per target to some or all of the targets on the active target list. The interrogations are timed so that nonoverlapping blocks of channel time are assigned to each individual interrogation and reply. If insufficient time is available to schedule all targets on the list, the time is allocated to targets according to a preassigned transaction priority.

Roll-call scheduling begins with the first (longest range) target on the list, scheduling an interrogation at the assigned start time of the schedule; next, the expected reply arrival time is computed and a suitable listening period provided. Subsequent targets are scheduled by placing their reply listening periods in sequence and computing the corresponding interrogation times. A cycle is completed when the next interrogation, if so scheduled, would overlap the first reply. This interrogation is deferred to start a new cycle.

Several types of transactions must be efficiently combined in forming a DABS schedule. Since the aircraft on the active target list are in various stages of completion, with respect to DABS activity, each one is likely to be represented on a given schedule by a different kind of transaction. Figure 3-4(a) illustrates a typical cycle comprised of long and short interrogations, coupled with long and short replies.

This cycle includes one synchronized transaction, shown crosshatched, which differs from the others in that the reply is separated from its neighbors by time buffers. These buffers are required for the prevention of interference on the Synchro-DABS air-to-air link.

The cycles shown in Figs. 3-4(b) and 3-4(c) illustrate the inclusion of downlink and uplink ELM transactions.

#### Channel Management Organization

The five subfunctions which comprise channel management are (a) channel control, (b) transaction preparation, (c) target list update, (d) roll-call scheduling, and (e) transaction update.

The data flow between these subfunctions, and their interfaces with other sensor functions, are illustrated in Fig. 3-5.

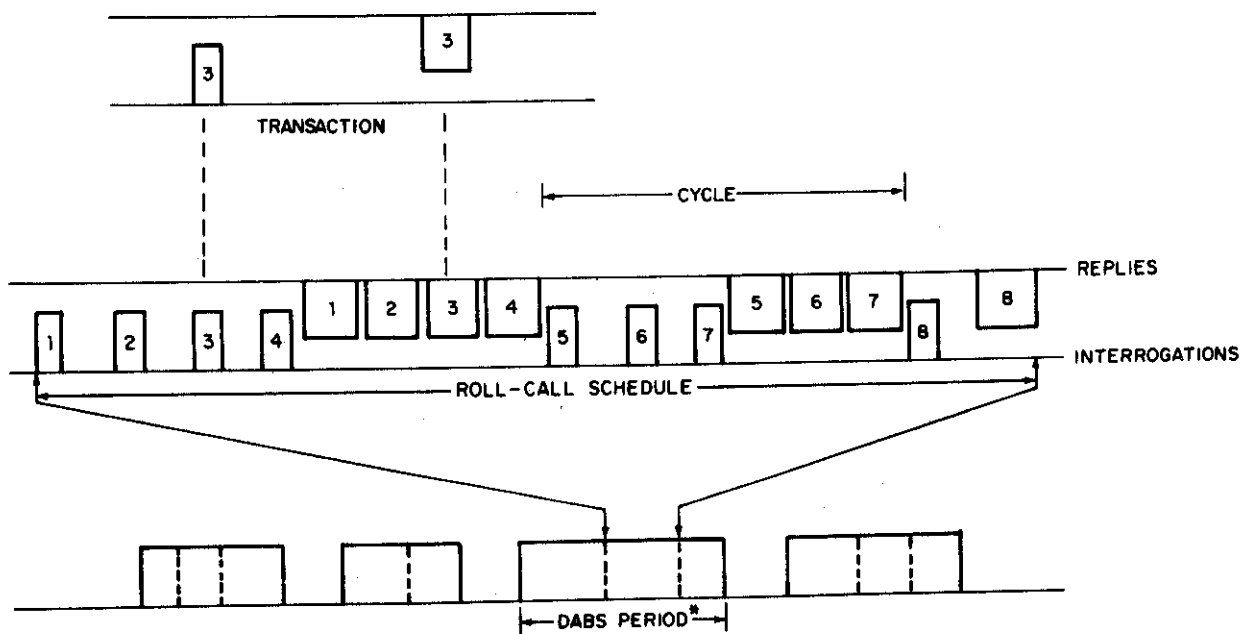

\*This DABS period comprises three schedules. The second schedule includes eight transactions, grouped in three cycles of 4, 3 and 1 transactions, respectively.

Fig. 3-3. DABS Roll-Call Scheduling.

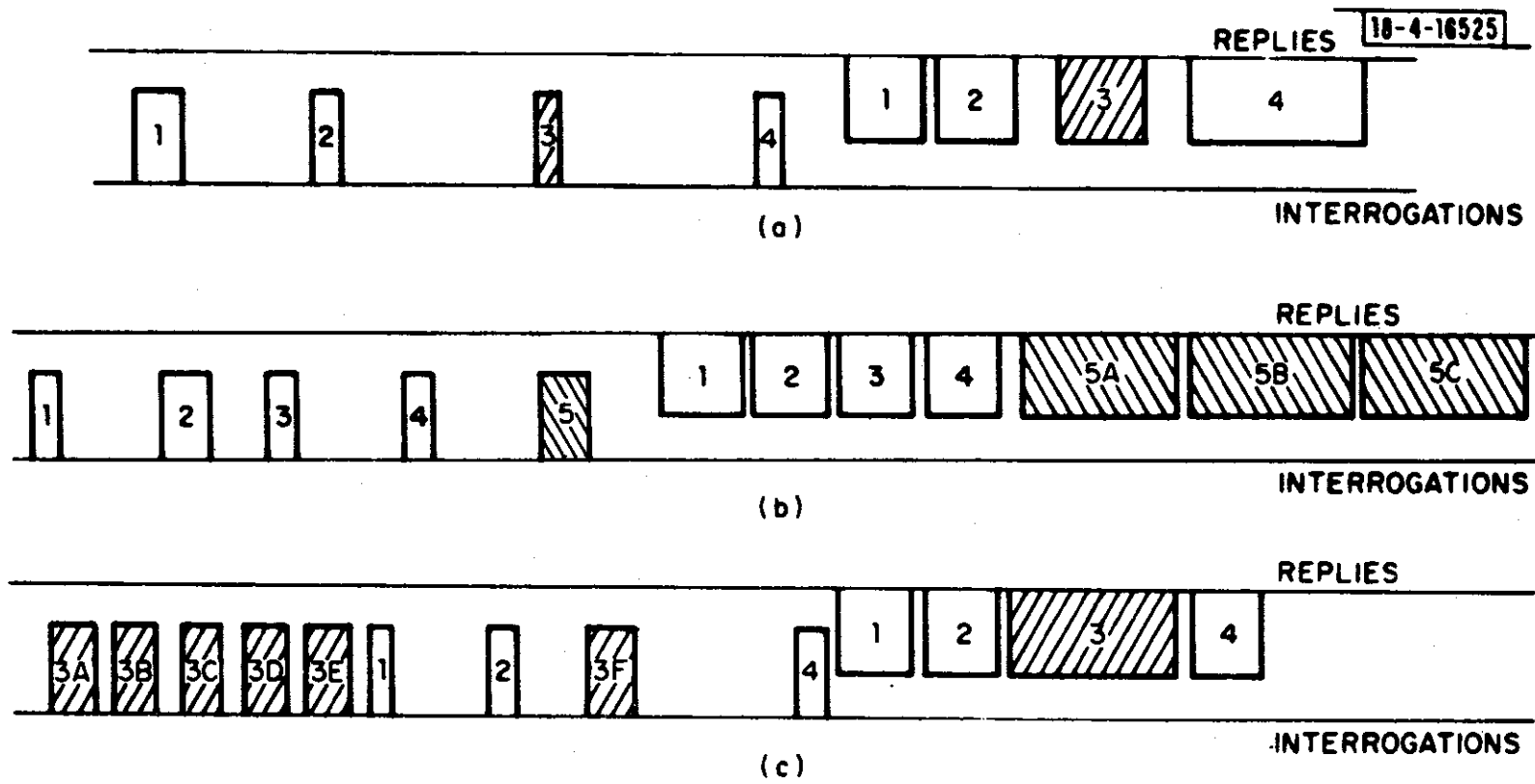

Fig. 3-4. DABS Cycles.

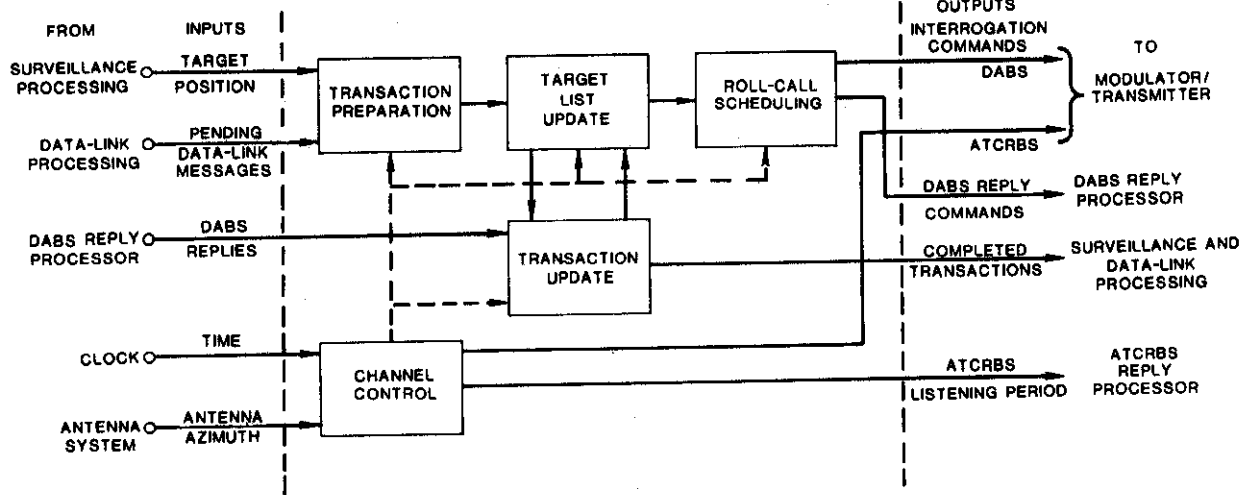

Fig. 3-5. Channel Management.



Interfaces: Channel management receives inputs from surveillance processing, data-link processing, and network management. Surveillance processing provides channel management with the predicted position (azimuth and range) of DABS aircraft. Data-link processing provides organized lists of pending uplink messages for each DABS aircraft. Network management controls the track state to define the kinds of service, both surveillance and communication, to be afforded each aircraft.

Channel management has control over the modulator/transmitter unit and the DABS and ATRCBS reply processors. Channel management communicates with these units by generating interrogation and reply control commands and by receiving DABS reply data blocks. When a target leaves the beam, a record of channel activity and downlink message content is passed on to the surveillance processing, data-link processing, and network management functions.

Channel Control: Channel control monitors the system real-time clock and the antenna pointing direction, seeing to it that all ATRCBS and DABS activities take place at the proper time and in the proper sequence. The other four channel management subfunctions are periodically activated by channel control. In addition, channel control regulates the flow of control commands to the modulator/transmitter and to the reply processors, and it directs the transfer of DABS reply data blocks from the DABS reply processor to channel management. In the back-to-back configuration, commands to the modulator/transmitter include an antenna face designation.

Transaction Preparation: At regular intervals, channel control directs transaction preparation to provide a list of targets about to enter the beam. For the back-to-back configuration, there are two such lists, corresponding to the two beams. Transaction preparation consults the surveillance file which contains predicted position, the pending uplink message data placed there by data-link processing, and control information generated by network management. If Synchro-DABS service, uplink messages, and/or downlink message requests are pending for a target entering the beam, transaction preparation will determine the number and type of transactions required to accomplish these tasks.

Transaction preparation creates a list of data blocks, one for each new target, containing a complete specification of the required set of transactions needed to accomplish all pending surveillance and communication tasks.

Target List Update: An active target list is updated regularly by the target list update subfunction. The entries on this list are the data blocks which have been formulated by the transaction preparation subfunction. Data blocks on new targets, supplied by transaction preparation, are merged into the list, while old targets, either leaving the beam or completely serviced, are removed.

In order to facilitate the computation of a nonconflicting schedule of interrogations and replies, an active target list is arranged in order of decreasing target range. This ordering is maintained each time the list is modified. In the back-to-back configuration, two active target lists are maintained.

Roll-call Scheduling: As directed by channel control, roll-call scheduling operates on the contents of an active target list to produce DABS schedules according to the procedures described earlier. If insufficient time remains for a complete schedule (i.e., one transaction per aircraft on the active target list) then the available time is allocated based on transaction priority as follows:

- Level 1 -Interrogations for surveillance, ATCRBS ID, synchronization and high priority Comm-A/Comm-B messages.
- Level 2 -Additional (low priority) Comm-A/Comm-B messages.
- Level 3 -Uplink ELM's
- Level 4 -Downlink ELM's.

The outputs of roll-call scheduling are DABS interrogation control blocks specifying interrogation time, power level, and data-block contents, and reply control blocks specifying expected reply time and address.

Transaction Update: If a target enters the beam with several transactions to be carried out, these transactions will normally take place on successive schedules. The transaction update function examines each reply and, if the transaction was successful, modifies the target's data block so that the next pending transaction will be carried out in the subsequent schedule. If the transaction was unsuccessful, it will be repeated in the next schedule, and the next pending transaction delayed to a later schedule. Finally, transaction update indicates the completion of targets for which no further transactions are pending.

#### CLOCK

Each DABS sensor is equipped with a "time-of-day" clock which permits precisely-timed coordination of activities at different sensors. Site-to-site synchronization of  $\pm 2.5$  milliseconds is required for utilization of multi-site surveillance data. If synchro-DABS were to be implemented in a mode using site-to-site coordination of interrogations, the synchronization requirement would change to the order of one microsecond.

System time is continuously available to the modulator/transmitter, DABS and ATCRBS reply processors, and channel management. In addition, the sensor clock provides timing references for the generation of both DABS and ATCRBS interrogation waveforms, and the demodulation of replies.

#### MODULATOR/TRANSMITTER

The modulator/transmitter (Fig. 3-6) accepts digital control inputs from channel management and generates the requisite RF interrogation signals. For each interrogation to be transmitted, the control inputs specify the mode, the transmission time (with  $1/16 \mu s$  resolution), and, for a DABS interrogation, the contents of the data block prior to encoding. The modulator generates the sequence of parity check bits and combines them with the specified discrete address.

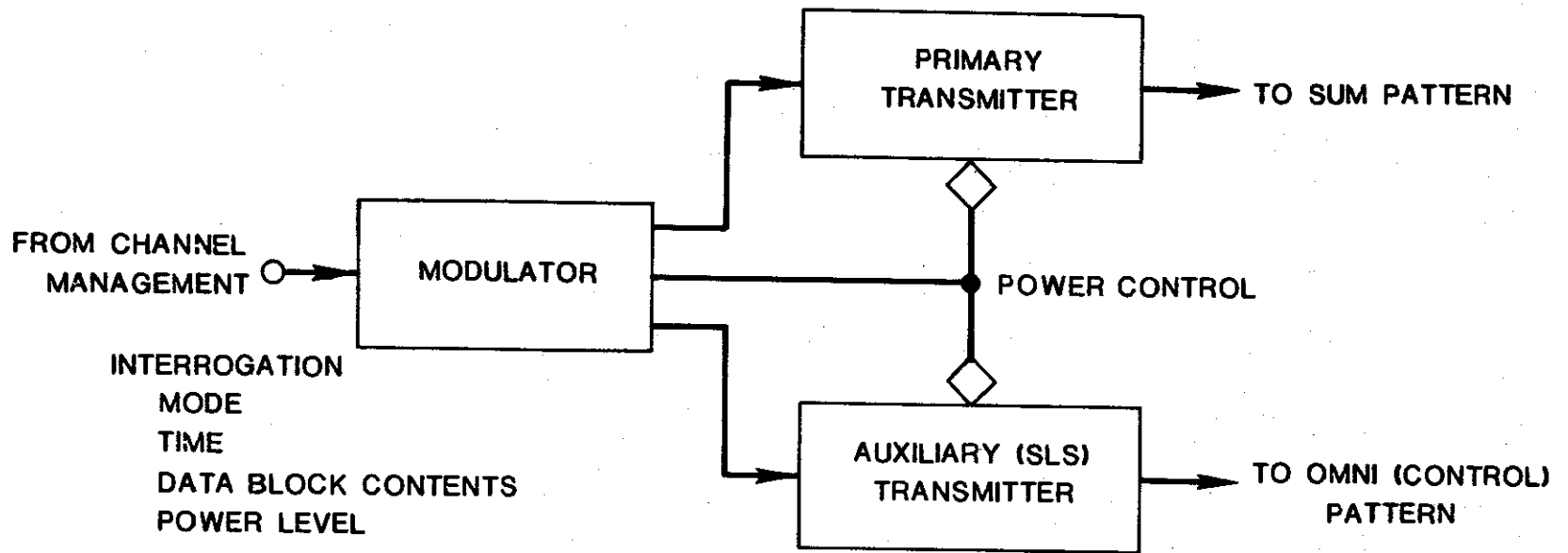

Fig. 3-6. Modulator/Transmitter.

DABS interrogations may be transmitted at low or high power (nominally 100 or 800 watts respectively) under control of channel management. ATRCBS transmit power is site-adaptable with nominal values of 300 watts for a terminal sensor and 800 watts for an enroute sensor.

An auxiliary transmitter is required for the generation of the SLS control pulses, since the DABS SLS pulse (P5) is transmitted simultaneously with the DABS interrogation.

#### ANTENNA SYSTEM

The DABS sensor employs a rotating fan beam antenna having two patterns, a sum ( $\Sigma$ ) pattern and a difference ( $\Delta$ ) pattern (Fig. 3-7(a)). The interrogation is transmitted, and the reply received, on the sum pattern; the reply is also received on the difference pattern, and the ratio of the amplitudes of the signals received on the difference and sum patterns (Fig. 3-7(b)) is used to estimate the off-boresight angle of the target, i.e., the angular difference between the target position and the antenna pointing angle.

In addition to the sum and difference patterns, the antenna system includes an SLS control pattern. This pattern is used for the transmission of the P2 and P5 sidelobe suppression pulses. It is also used on receive, where comparison of the amplitudes of the same signal received on the sum pattern and the control pattern permits rejection of signals received via a sidelobe of the sum pattern.

To perform its function, the gain of the SLS control pattern exceeds that of the sum pattern in all directions except those corresponding to the main beam of the sum pattern, i.e., it should "cover" the sidelobes of the sum pattern.

Historically a separate antenna has been used to generate the SLS control pattern which has nearly constant gain as a function of azimuth, i.e., is omnidirectional in azimuth; the control pattern is thus referred to as the omni ( $\Omega$ ) pattern. However, other control pattern characteristics are employed such as that associated with an SLS antenna designed as an "integral" part of the sum and difference antenna. Generally this approach employs an auxiliary control pattern radiator in the rearward direction to ensure adequate coverage of the sum backlobes.

#### Antenna Configuration

The DABS antenna system may either stand alone, mounted on its own pedestal, or it may share a pedestal with a radar sensor. The latter will be the case when a DABS and radar are collocated.

When sharing a pedestal with a radar antenna, the DABS antenna employs a completely separate radiating structure, mounted, for example, above the radar antenna. On slowly rotating radar antennas (long-range air route surveillance radars which rotate at 5 to 6 rpm), back-to-back beacon antennas are used to realize a beacon data update rate twice that of the host radar.

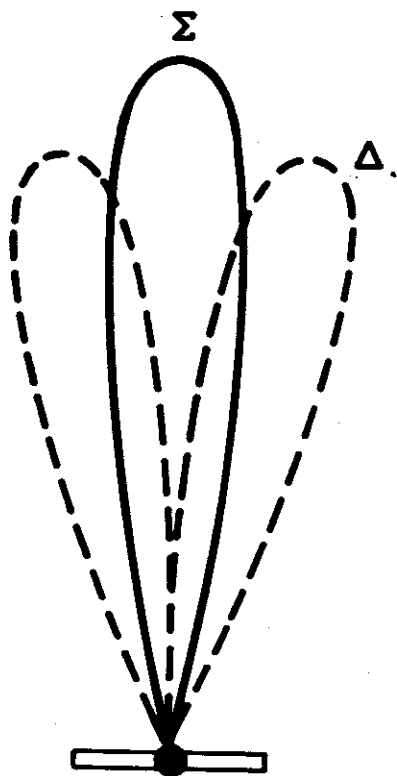

(a)

$\Sigma$  SUM  
 $\Delta$  = DIFFERENCE  
 $\theta_{ob}$  = OFF-BORESIGHT ANGLE

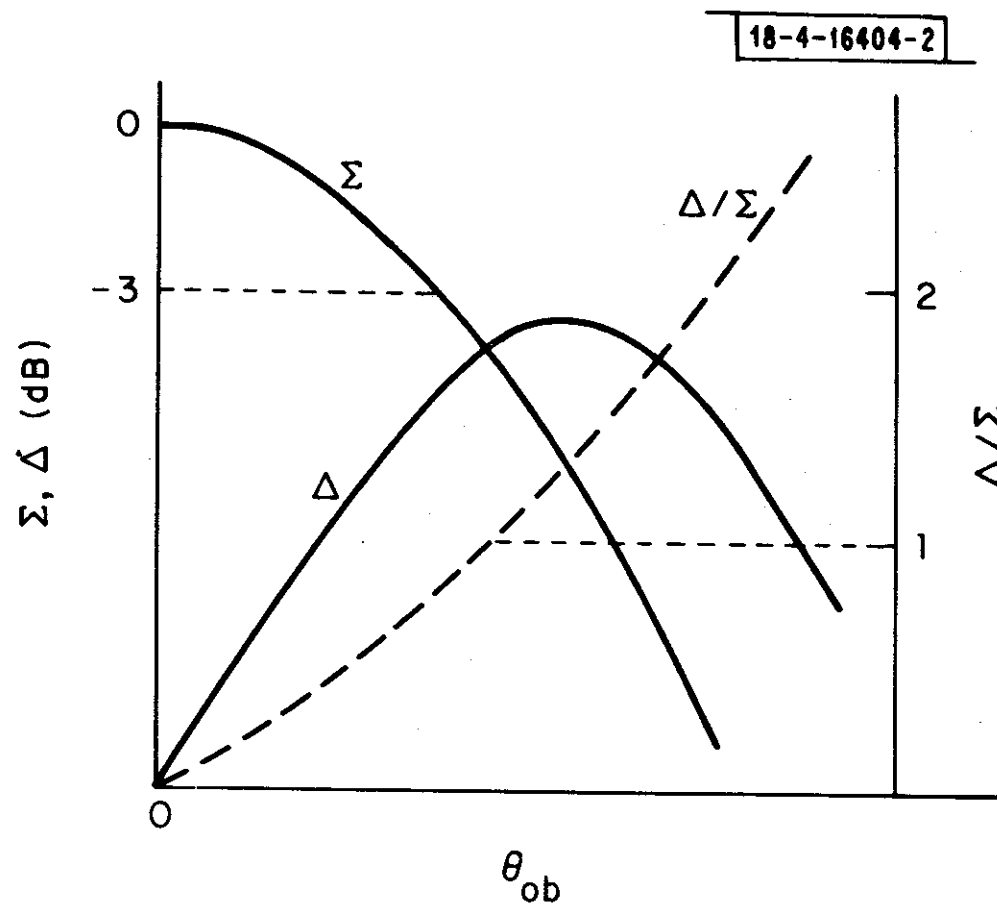

(b)

Fig. 3-7. Sum and Difference Antenna Patterns.

The back-to-back beacon antennas are mounted atop the collocated radar antenna if space permits. If space is restricted, such as in a radome, the forward antenna is chin mounted on the radar feed support boom with the rearward antenna mounted at approximately the same height on the backside of the radar antenna.

Some en route interrogators operate jointly for the benefit of both the FAA and the Military Air Defense Command. In this situation the antennas and associated microwave signal paths are configured to allow the military exclusive use of one antenna (the front face) for their Mode 4 surveillance purposes when requested. Each such military request would generally encompass an azimuth wedge of from 10 to 30 degrees within a single scan. The enroute DABS update rate, would of course, revert to one-half of the normal rate during this interval.

A block diagram of the configuration of a DABS sensor and military interrogator operating jointly is shown in Fig. 3-8.

#### Azimuth Pattern Characteristics

The choice of azimuth beamwidth is constrained by two conflicting requirements. A broad beam results in a higher target capacity, i.e., the sensor can provide discrete-address surveillance and data-link service to a larger number of aircraft (see Chapter 5). A narrow beam provides higher azimuth measurement accuracy. The most generally useful range of a 3-dB azimuth beamwidth for the DABS sensor appears to be 2.4 to 4 degrees.

Both sum and difference patterns must have low amplitude azimuth sidelobes to minimize the effects of sidelobe interference on reply detection and monopulse azimuth estimation.

#### Elevation Pattern Characteristics

A rapid cutoff of the antenna patterns at the horizon is desirable to minimize the energy incident on, and reflected by, the ground, and thereby to:

- (a) decrease the magnitude of lobing; and
- (b) reduce the error introduced in the azimuth measurement due to off-axis multipath signals.

While the specific requirements on lower edge cutoff are highly site-dependent, a cutoff rate of approximately 2 dB per degree appears adequate for most typical site environments.

Above the horizon, the DABS sensor must provide coverage to elevation angles of 30 to 40 degrees. Current beacon sensors use antennas having relatively constant gain with elevation angle (termed sector beams); used with sensitivity-time control (STC), this minimizes the dynamic range requirements of the receiver. A more tapered pattern (intermediate between the sector beam and the cosecant-squared pattern frequently used in radar applications) is preferred for DABS. The tapered pattern has greater gain near the horizon,

**NOTE:** NORMAL MODE 4/FRONT FACE CONFIGURATION SHOWN.

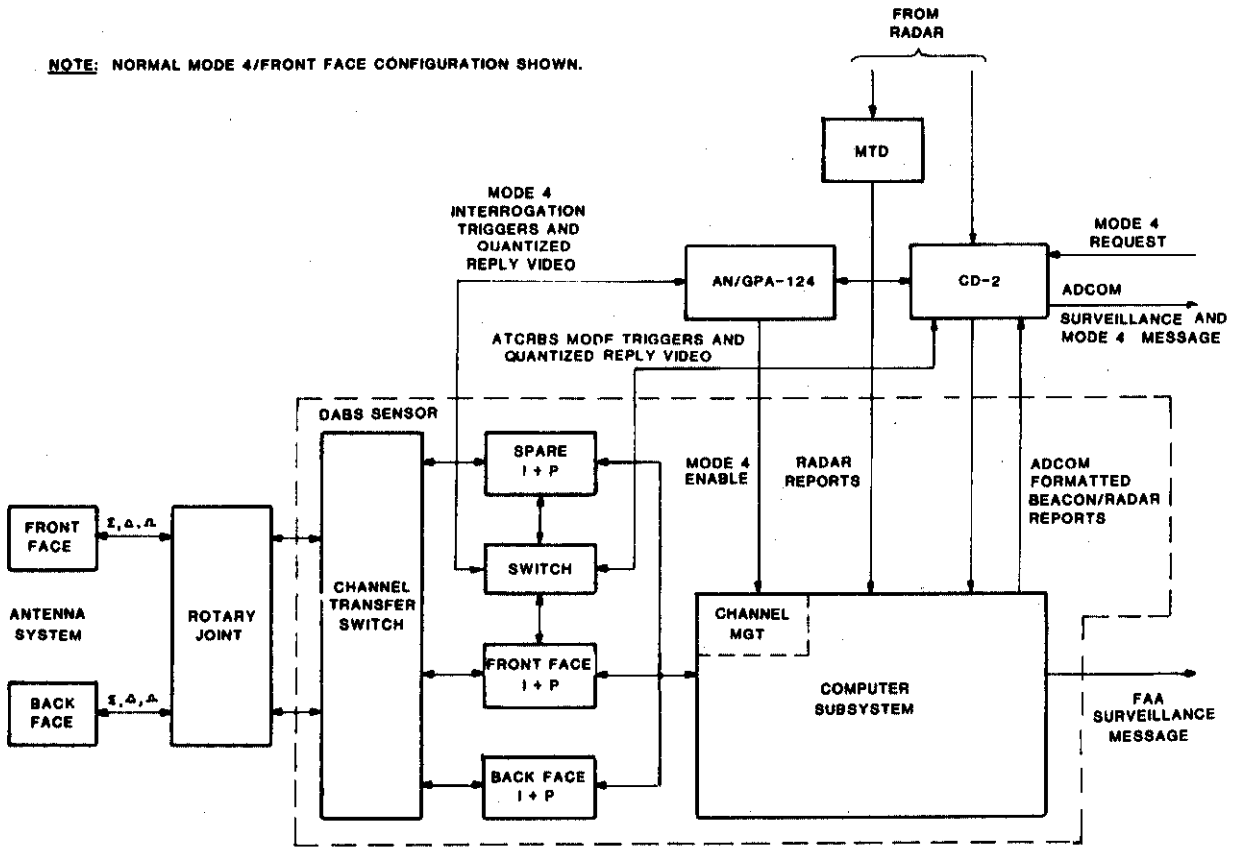

Fig. 3-8. DABS Joint Use Enroute Sensor.

providing a higher fade margin for long-range, low-elevation angle targets. Its lower gain at high elevation angles is balanced by the reduced range of aircraft at those elevations.

Each of the above pattern characteristics are typified in Figs. 3-9(a) and 3-9(b). Figure 3-9(a) illustrates the measured elevation pattern of a representative DABS five-foot open array designed for constant gain with elevation angle. Figure 3-9(b) illustrates the measured elevation pattern of a five-foot open array with a more nearly cosecant-squared characteristic as a function of elevation angle. Both antennas have a sharp lower edge cutoff. The peak-of-beam gain of the tapered pattern antenna is approximately 3-4 dB greater than that of the constant gain antenna.

#### MULTICHANNEL RECEIVER

The multichannel receiver accepts the three RF signals from the sum, difference, and omni (control) patterns of the antenna system, and produces three outputs for use by the ATCRBS and DABS reply processors. These outputs are:

- (a)  $\log \Sigma$  -the log amplitude of the sum pattern signal;
- (b)  $\log \Omega$  -the log amplitude of the omni pattern; and
- (c)  $f(\Delta/\Sigma)$ -a bipolar video signal proportional to the ratio of the amplitudes of the difference to sum pattern signals.

The  $\log \Sigma$  signal is the "principal" receiver output, used for the detection of reply pulses. Comparison of the amplitudes of the  $\log \Sigma$  and  $\log \Omega$  signals indicates whether a pulse detected in the  $\log \Sigma$  output was received via the mainlobe ( $\log \Sigma > T^* + \log \Omega$ ) or via a sidelobe ( $\log \Sigma < T^* + \log \Omega$ ) of the sum pattern. The digitized value of the  $f(\Delta/\Sigma)$  signal from each received pulse is compared with a prestored antenna/receiver calibration curve to provide an estimate of the angle of arrival of the signal relative to the antenna boresight.

Figure 3-10 is a block diagram of a possible realization of the multi-channel receiver. The figure illustrates the use of the so-called "half-angle monopulse processor" to generate a  $f(\Delta/\Sigma)$  output which is unambiguous (i.e., single-valued) over the full range of values of  $\Delta/\Sigma$ , approximately according to the relationship:

$$f(\Delta/\Sigma) = 2 \tan^{-1} (\Delta/\Sigma).$$

The half-angle monopulse processor provides a highly accurate and stable calibration characteristic over a wide range of input signal amplitudes.

#### DABS REPLY PROCESSING

DABS reply processing operates on the multi-channel receiver outputs to detect and decode DABS all-call and roll-call replies, and to generate an estimate of target range and azimuth from each detected reply. The principal steps in DABS reply processing are depicted in Fig. 3-11.

\*A preset threshold.



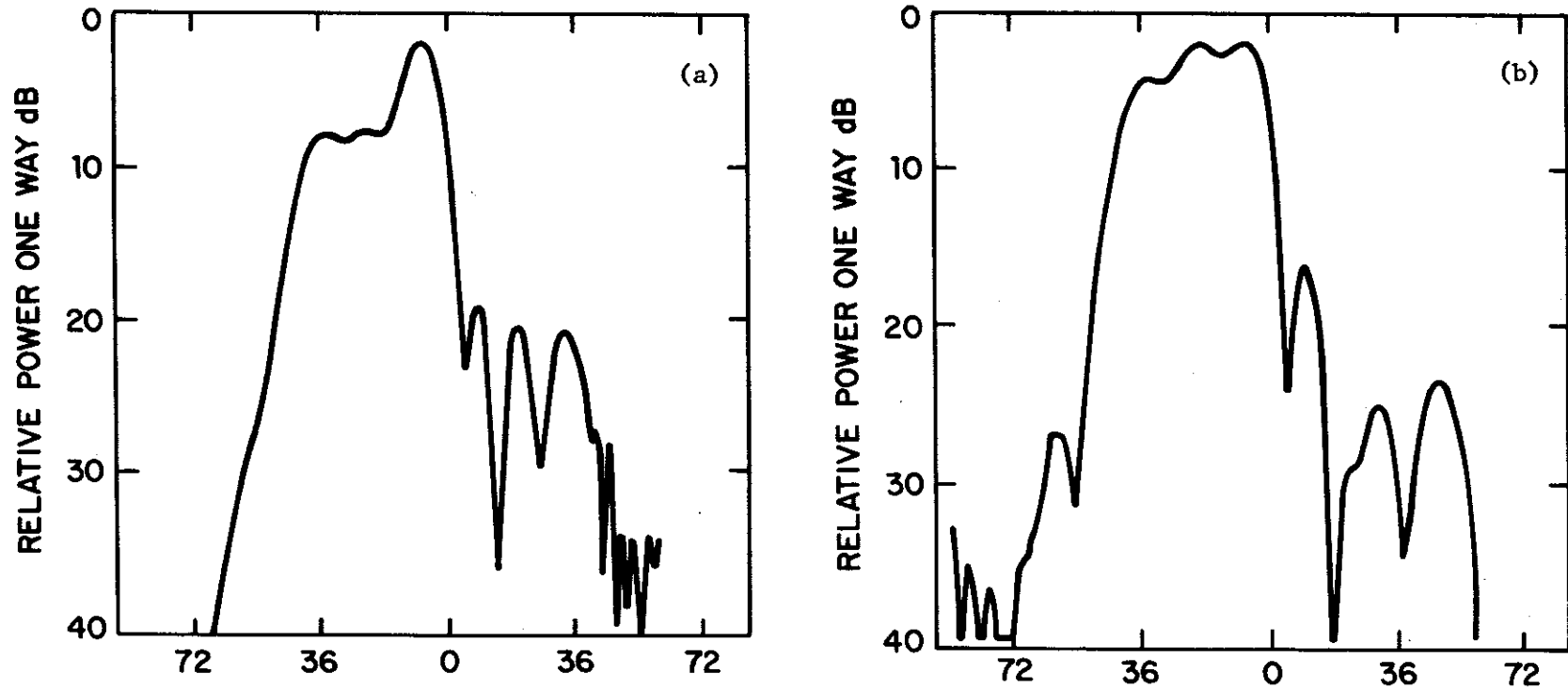

Fig. 3-9. Elevation Pattern of a Five Foot Open Array Antenna.

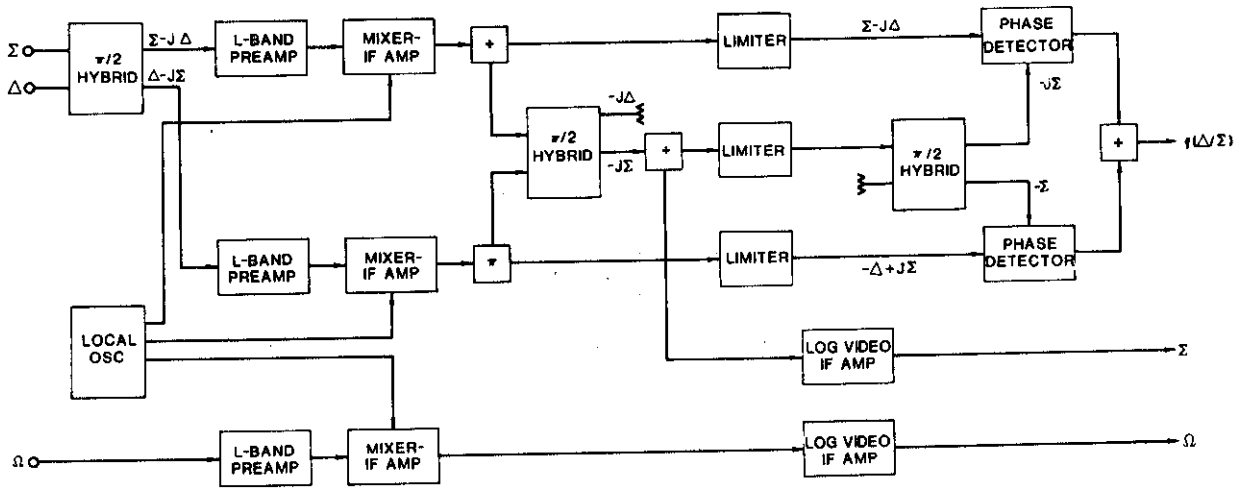

Fig. 3-10. Multi-channel Receiver.

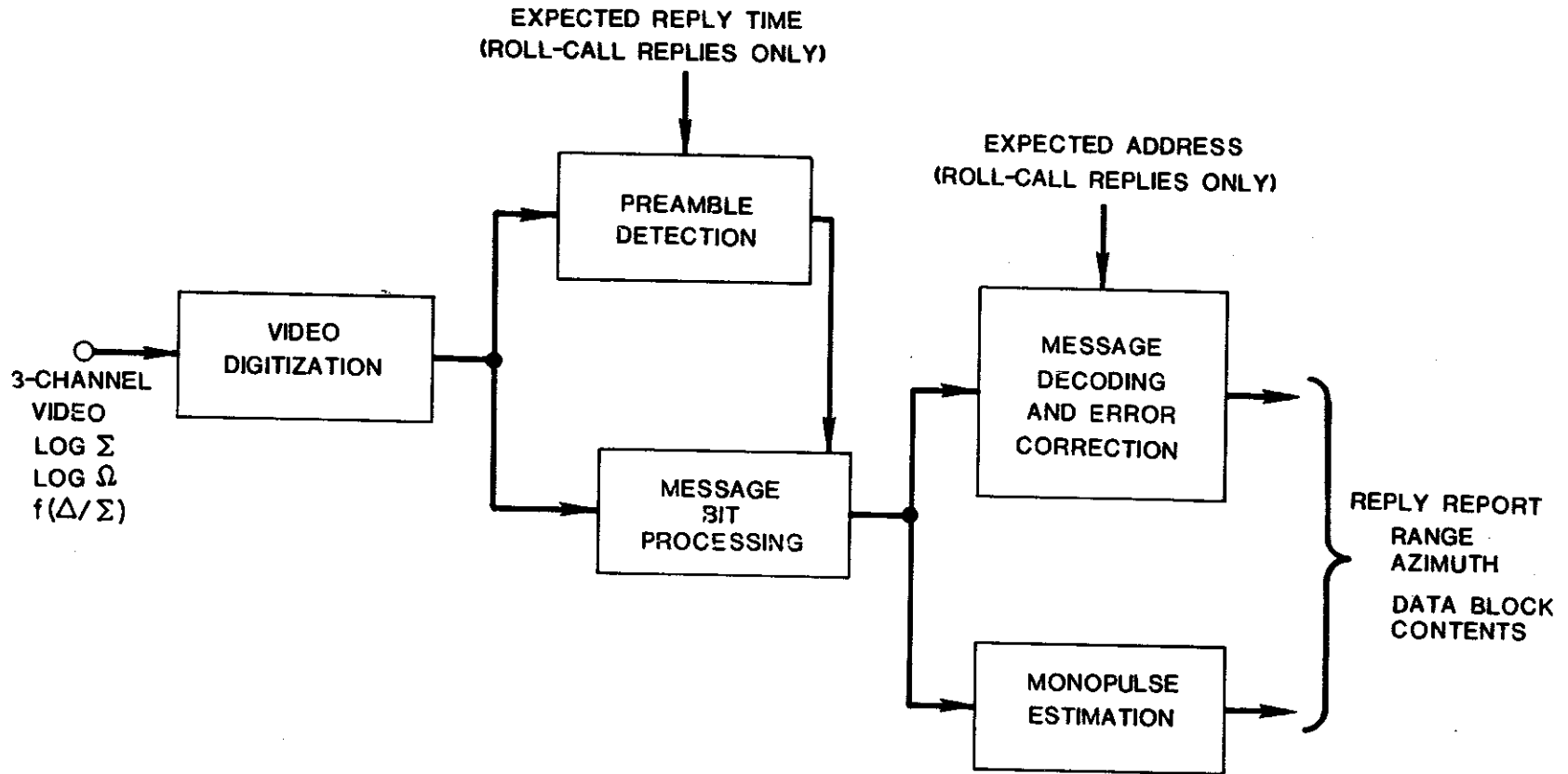

Fig. 3-11. DABS Reply Processing.

### Preamble Detection

DABS replies are detected on the basis of the four-pulse preamble waveform preceding the reply data block. The preamble detector provides accurate time-of-arrival estimation for target ranging and for synchronization of message bit processing and reply decoding.

In the case of replies to roll-call interrogations, channel management provides to the preamble detector an estimate of expected reply time and an uncertainty window. A reply is accepted only if its preamble is detected within this window. Since the reply processor cannot start decoding a new reply when it is still decoding an earlier one, the use of this window minimizes the probability that the reply decoder will miss the desired reply due to DABS fruit.

### Message Bit Processing

Message bit processing operates on sampled video waveforms to produce a sequence of demodulated message bits, and a confidence bit (high or low) for each demodulated message bit.

Since a message bit is transmitted as a pulse in one of two possible positions, depending on whether the bit value is a 0 or a 1, bit decisions are based primarily on the relative amplitudes of the signals received in these two pulse positions. The sidelobe flag is used to help resolve ambiguous situations in which a signal is received in both pulse positions.

Bit decisions are indicated as high confidence only when a mainbeam signal appears in one pulse position, and either no signal or a sidelobe signal appears in the other.

### Message Decoding and Error Correction

Message decoding uses the parity check code to detect errors on the demodulated message. Since in roll-call replies the parity check bits are combined with the transponder address, the decoder must know the expected address (supplied by channel management) in order to perform error detection.

Whenever a decoded reply contains errors, error correction is attempted if the total number of low-confidence bits in the reply does not exceed a preset threshold. The use of this threshold minimizes the possibility of erroneously "correcting" a reply which contains a very large number of errors. Error correction will be successful only if:

- (a) all errors are confined within a span of 24 contiguous bits, and
- (b) all errors occur in bits flagged as low confidence.

Garbling by a single strong ATRBS reply, which can result in bit decision errors spanning no more than 24 bits, usually results in a correctable error pattern. Thus, with high probability the DABS data block will be correctly decoded unless it is garbled by more than one strong ATRBS reply.

## ATCRBS REPLY PROCESSING

The ATCRBS processing subsystem has been designed to produce accurate, reliable target reports at low interrogation rates in order to maximize the channel time available for the DABS mode of operation. Monopulse information is used both to determine target azimuth and to assist in the decoding of overlapped replies. Sidelobe fruit replies are detected and rejected by comparison of the signal amplitudes received on the sum and omni patterns. ATCRBS modes A, C, and 2 replies are processed, and the extracted codes included in the target report.

ATCRBS reply processing takes place in three successive steps (Fig. 3-12):

- (a) Reply decoding operates on the three video outputs of the multichannel receiver to detect ATCRBS replies, and, for each detected reply, provides an estimate of target range, azimuth, code and code confidence.
- (b) Reply correlation attempts to combine all replies received from an aircraft during one interrogator antenna scan into a single target report containing target range, azimuth, code and code confidence for each mode (A,C,2) in which the target responded.
- (c) Report-to-track correlation edits, and corrects as necessary, target reports by comparing them with a track file generated from reports received on previous scans. This step assists in the elimination of mainbeam fruit, the flagging of false targets, and the correction of missing and garbled code pulses.

The first two steps are described in the remainder of this section. The final step, report-to-track correlation, is discussed in a later section on surveillance processing.

### Reply Decoding

The major elements of ATCRBS reply decoding are illustrated in Fig. 3-13.

Video Digitization: provides a digital representation of pulses whose widths are within an acceptable range. This representation includes leading edge location, a monopulse sample, and a sidelobe flag. Overly long pulses are assumed to have resulted from an overlapping of pulses from two replies, and pseudoleading edges are inserted based on the observed trailing edge position.

A monopulse sample is produced for each pulse of acceptable width, except for pulses which are overlapped enough to result in garbled monopulse samples.

Bracket Detection: is based on the detection of two pulses in the leading edge data stream which have the appropriate spacing ( $\approx 20.3 \mu\text{s}$ ). Bracket pulse

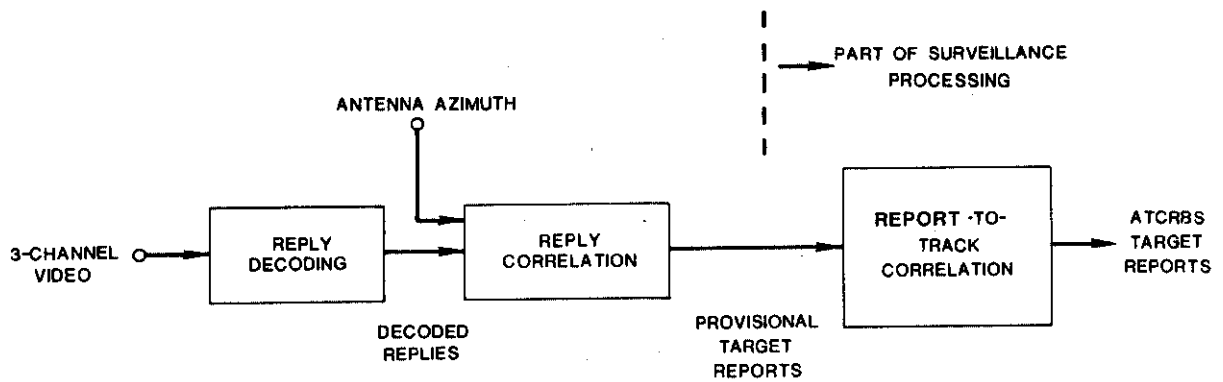

Fig. 3-12. ATCRBS Reply Processing.

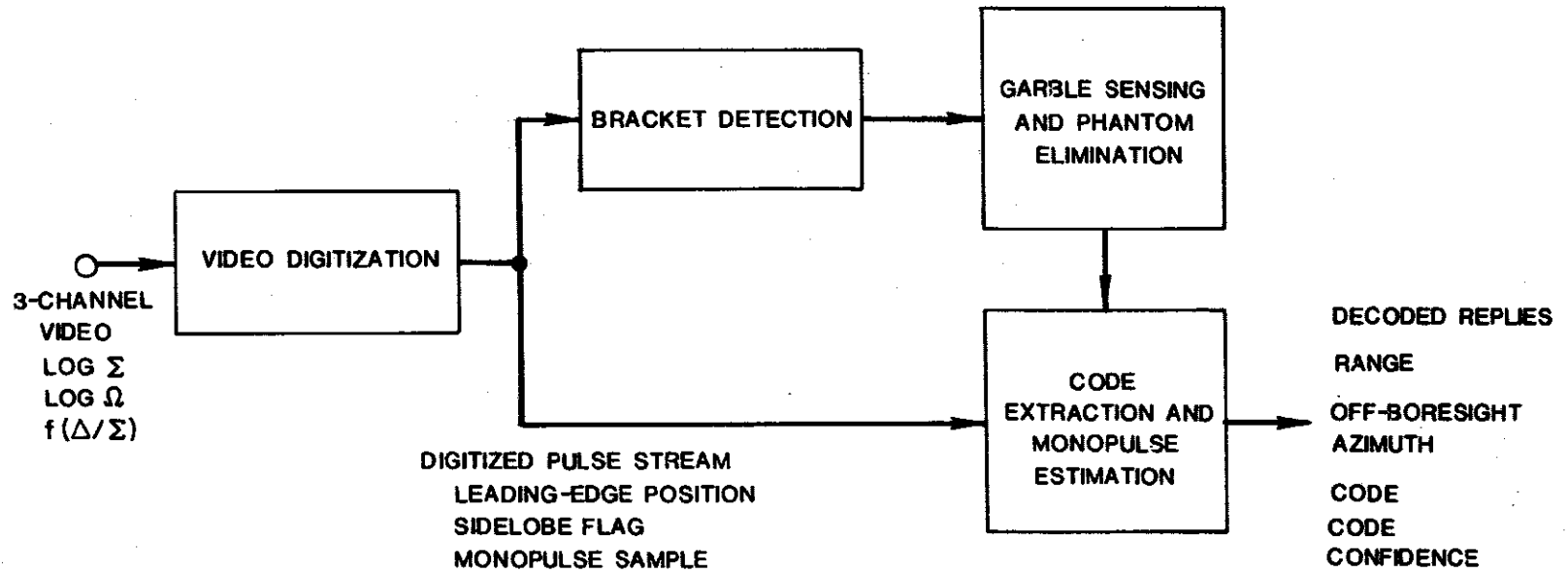

Fig. 3-13. ATCRBS Reply Decoding.

pairs for which both pulses are flagged as sidelobe pulses are not declared, and thus sidelobe replies are not decoded.

Garble Sensing and Phantom Elimination: Garble sensing is based on the time separation of two detected bracket pairs which would result in overlapping pulse decode regions for the two replies. The incorrect declaration of a bracket pair made up of pulses from two garbling replies is termed a "phantom." Phantoms produced by two garbling replies will be correctly eliminated if no additional garbling reply occurs for 20.3  $\mu$ s.

Code Extraction: Code extraction is initiated by the declaration of a bracket pair, which defines the possible information pulse locations. Information pulses are associated with a reply (bracket pair) on the basis of their leading edge location relative to the bracket pair and their monopulse sample values relative to a monopulse reference. The initial monopulse reference is the monopulse sample of the first framing pulse, except when that pulse is in a possible garble region of an earlier reply or is labelled as sidelobe. If the first framing pulse is not suitable, the monopulse sample of the second framing pulse is used as the monopulse reference. If that pulse is also not suitable, the reply is rejected.

Each information pulse decision is accompanied by a confidence bit (high/low confidence). A pulse is decoded as high confidence, '1', if it falls within one of the acceptable pulse decoding regions of the reply being decoded and its monopulse sample correlates with the monopulse reference of that reply and not with any garbling reply (if any). A pulse position is decoded as high confidence, '0', if no pulse is detected in its decode region and no pulse leading edge is detected in the sample position just ahead of this decode region.

Monopulse Estimation: Each pulse which lies within a valid information pulse position of a detected reply and which correlates with the monopulse reference of that reply is used to update the reference by averaging the reference value and the sample value. The monopulse estimate for a decoded ATRBS reply is the final value of the monopulse reference for the reply at the time the  $F_2$  pulse has been processed. In order to avoid an erroneous monopulse estimate because of a bad reference sample at the start of pulse decoding, an ATRBS monopulse estimate is not declared unless it includes at least two monopulse samples.

### Reply Correlation

The function of reply correlation is to combine all replies received from a transponder in one scan into a single target report. Each reply received from reply processing is correlated (compared) in range, azimuth and high-confidence code pulses with existing target report files. If a reply does not correlate with any existing target report file, a new file is started with the reply.

Code correlation is done by comparing only high-confidence code positions of a reply with the high-confidence code positions of the code estimate contained in the target report file. This code estimate (mode 2, A or C) is up-



dated by forming a new estimate consisting of the composite of the current file code estimate and the high confidence code positions of the correlating reply. Likewise, the composite confidence bit sequence for each reply mode is updated by adding to the high confidence positions in the target report file any new high confidence positions in the correlating reply.

The azimuth estimate provided in a target report consists of the azimuth estimate of the reply closest to boresight when replies are received only on one side of boresight, or the average of the azimuths of the two replies which straddle boresight.

### SURVEILLANCE PROCESSING

Surveillance processing maintains target files on all ATRCBS, DABS, and radar-only aircraft within the sensor's coverage volume. Its principal functions are:

- (a) To predict next-scan position of DABS aircraft for interrogation scheduling;
- (b) To edit and correct ATRCBS target reports based upon data from previous scans;
- (c) To perform radar/beacon correlation of target reports from a collocated radar;
- (d) To filter radar-only target reports based upon data from previous scans;
- (e) To disseminate composite ATRCBS/radar and DABS/radar surveillance data to ATC users.

The data flow between the principal elements of surveillance processing is illustrated in Fig. 3-14.

### DABS Surveillance Processing

DABS surveillance processing (Fig. 3-15) operates on the set of DABS replies received from an aircraft during a scan to produce a target report on that aircraft and a prediction of its position on the next scan.

A single DABS report for a given address is selected to represent the surveillance data for each track. Many reports with the same address may be present, either because of multiple roll-calls for data-link activity or because this aircraft is just being acquired and has answered an all-call. The report selection process includes finding the report which is near beam center to maximize azimuthal accuracy, and also finding the report at shortest range to exclude false (reflected) targets.

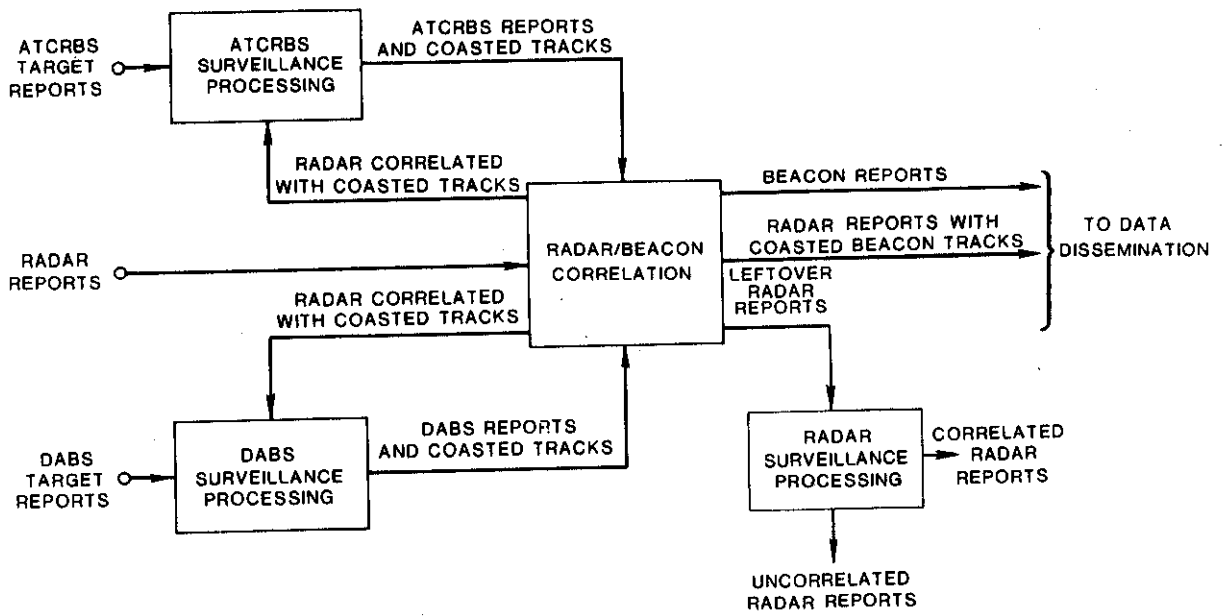

Fig. 3-14. Surveillance Processing.

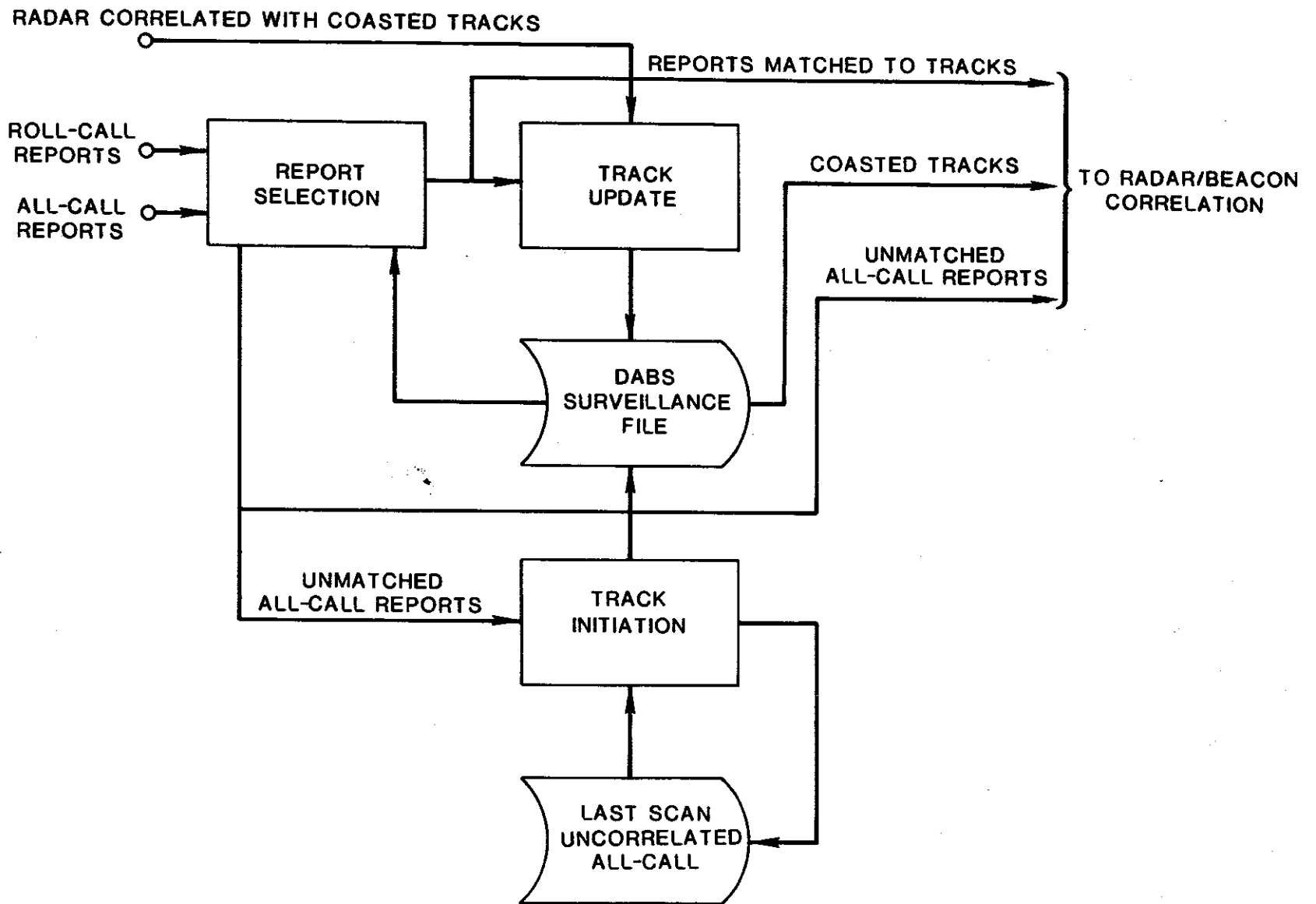

Fig. 3-15. DABS Surveillance Processing.

The DABS all-call reports whose address does not match an existing track are examined in the track initiation process to determine if an address match can be made with uncorrelated reports held over from the previous scan. When a match is found, a test for false track due to reflection is made; if the test is negative, a newly-initiated track is entered into the surveillance file. The still-unmatched reports are saved for one scan and are also used in radar correlation.

The occurrence of synchronous garble of DABS all-call replies is signified by the receipt of two or more undecodable all-call replies at a consistent range during a beam dwell. When this condition is detected, an acquisition track is initiated at the range and azimuth of the detected reply. Channel management will then schedule stochastic DABS-only all-call interrogations for this track when it appears on the active target list. If a successful reply is received, the aircraft will then be discretely interrogated and locked out to remove it from the garbling set. Acquisition tracks are only retained for one scan since continued garbling will result in generation of a fresh acquisition track each scan.

Finally, all DABS reports that match with tracks, and radar reports that correlate with coasted tracks, (i.e., tracks that were not matched to a DABS report this scan), are used to update and project the DABS track ahead one scan. This new projection is used by channel management to determine when to schedule the next roll-call interrogation to the aircraft.

#### ATCRBS Surveillance Processing

ATCRBS surveillance processing (Fig. 3-16) edits, and corrects as necessary, ATCRBS target reports by comparing reports received on the current scan with target tracks derived from reports received on previous scans. Editing includes eliminating residual fruit replies which may have been passed by the ATCRBS reply correlator, and flagging reports suspected of being due to reflections, i.e., false targets. When target reports correlate with an existing track, missing or low-confidence code bits may be corrected by insertion of the corresponding bits from the track file.

The lack of a unique identity code as part of each ATCRBS reply (as opposed to DABS replies) makes necessary a report-to-track correlation function as the first step in ATCRBS surveillance processing. Report-to-track correlation is based upon the several attributes of the report. A report is said to be associated with a track if it falls within a specified range, azimuth, altitude association interval. Then, if only one ATCRBS report associates with a single track, that report/track pair is declared correlated. For those cases where more than one report associates with a track, or more than one track associates with a report, or both, report and track correlations are based upon the following factors:

- (a) code match
- (b) number of replies in the report
- (c) altitude match

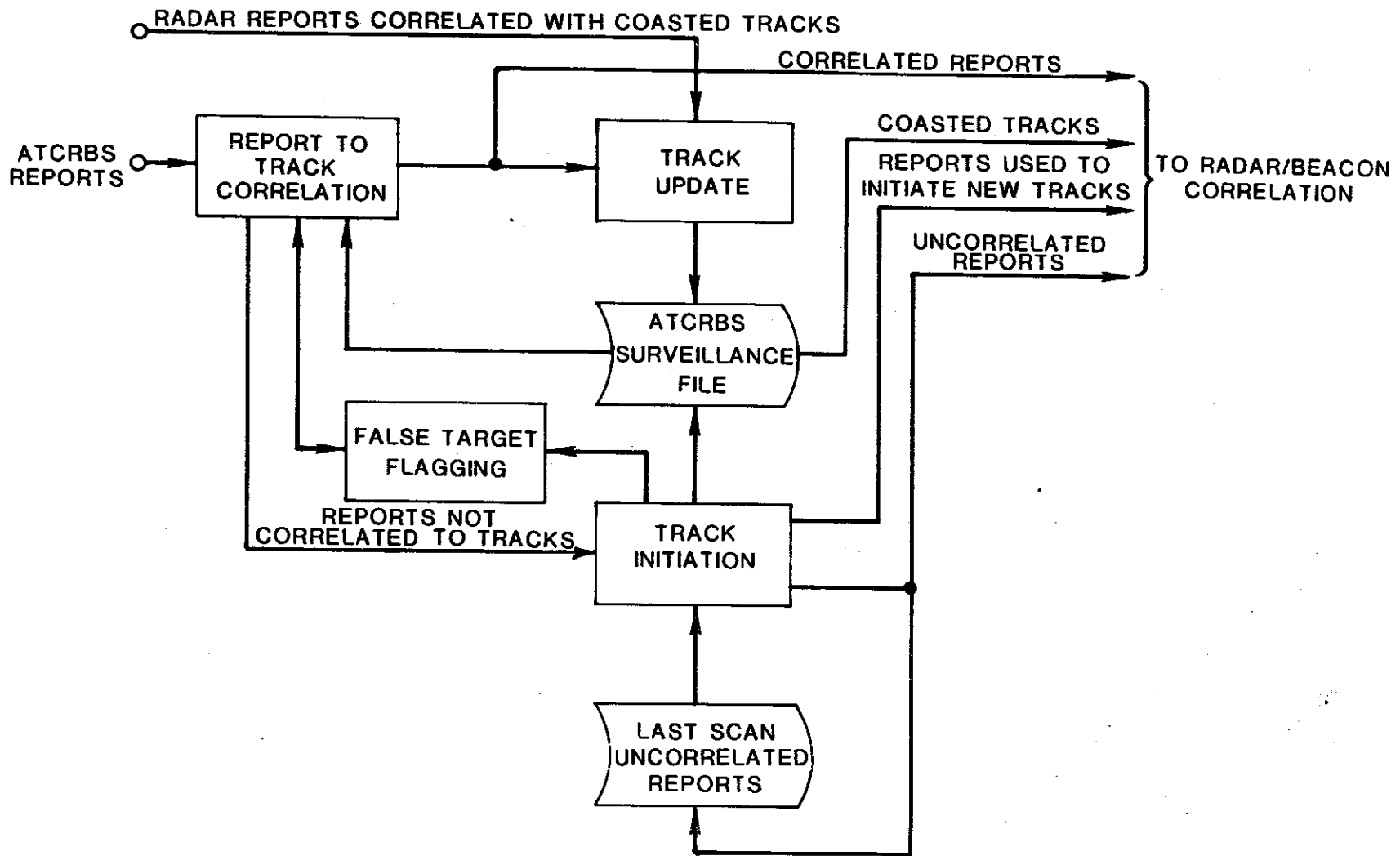

Fig. 3-16. ATCRBS Surveillance Processing.

- (d) track maturity
- (e) distance parameter.

During track update, a special code situation is sensed. If the mode A code of the report does not match the code of the track, it is assumed that a code change has been made in the aircraft and a transition situation is noted. After three scans of consistent new code, the track file code is updated.

ATCRBS fruit are discarded by rejection of all reports that do not correlate with a track and which are comprised of a single mode A reply, a single mode C reply, or two replies -one mode A and one mode C.

The test for determining whether a report is false (i.e., due to a reflection) is initiated by comparing the ATCRBS report azimuth with a stored table of reflections zones. If the report is in one of the reflection zones, then an image location is calculated and compared against known tracks. If a known track with matching altitude and mode A code could have caused the report, the report and any track started from it will be tagged as potentially false. Each scan thereafter, the false track is examined to see if it continues to satisfy the "false track" criteria.

#### Radar/Beacon Correlation

The last step in beacon surveillance processing prior to data dissemination is the comparison of radar reports from a collocated radar with the result of DABS and ATCRBS report processing.

A radar report correlates with a beacon report or track if it satisfies certain distance criteria. When a radar report and a beacon report correlate, the beacon report is said to be radar reinforced. When a radar report correlates with a beacon track for which no beacon report was received during the current scan, the track is updated using the radar report, and a radar substitution report is disseminated.

#### Radar Surveillance Processing

Radar surveillance processing (Fig. 3-17) compares current scan radar reports with those received on previous scans in order to filter out reports representing false alarms from clutter, birds, automobiles, or other system effects. Only radar reports not correlating with beacon reports or tracks enter into this process, thus preventing two tracks from being created for one aircraft. Only radar reports correlating with existing radar tracks are output, thereby preventing a high false alarm rate from affecting surveillance link throughput.

Since radar reports have neither an identity code nor an altitude, both the report-to-track correlation and track initiation procedures are more subject to error than with ATCRBS reports. The process of association is essentially one of range and azimuth testing, although the presence of doppler velocity in an MTD radar system provides another, although weak, association attribute.

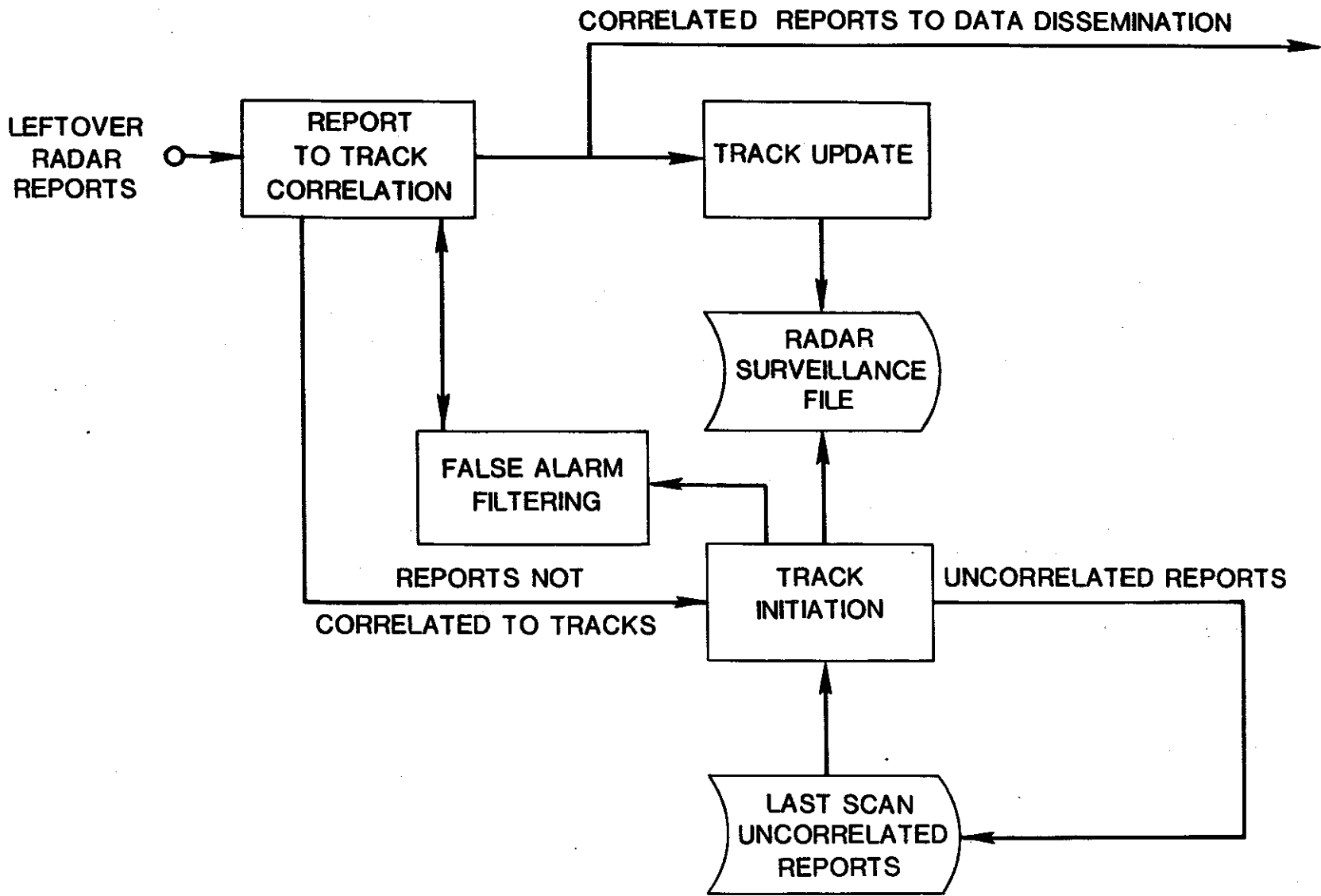

Fig. 3-17. Radar Surveillance Processing.

To overcome the higher false alarm rate and lack of correlation criteria, radar tracking is more cautious than the ATCRBS version. In particular:

- (a) more reports are required to initiate a track,
- (b) reports are flagged in certain site-dependent areas known to contain roads or severe clutter,
- (c) more smoothing is employed in the prediction equations.

#### Surveillance Data Output

At the completion of surveillance processing there are several classes of reports to be disseminated. These are:

- (a) beacon, radar reinforced;
- (b) beacon, not radar reinforced;
- (c) radar correlated with coasted beacon tracks; and
- (d) correlated radar.

Reports are selected for dissemination to connected ATC facilities through the use of a site adaptable dissemination map. This dissemination map defines the areas of interest for each ATC facility in terms of a minimum and maximum range and altitude for each  $1\frac{1}{4}^\circ$  azimuth sector.

#### DATA-LINK PROCESSING

Data-link processing regulates the flow of messages on the air-ground link. This is accomplished through the maintenance of a file, called the active message list, which contains a record of all of the pending communications activities. Entries in this file are organized by DABS address and are used by channel management to determine the number and type of interrogations and replies to schedule for an aircraft when it is available in the antenna main-beam.

As shown in Fig. 3-18, the two major subfunctions of data-link processing operate to update the active message list. Input processing handles messages received from ground users of DABS and in general is involved with additions of ground-to-air messages to the active message list. Output processing examines the transaction record prepared by channel management. The transaction record together with reply message contents indicate which communication activities are complete and which, if any, transponders are requesting an air-to-ground message transfer.

#### Input Processing (Fig. 3-19)

Communication messages (Ref. 6) may be received from the ATC interface, the ATARS functions at the local and adjacent sites, and data link applications processors. In order to be considered for delivery during the current scan, a message must be received by the sensor at least two sectors ( $22\frac{1}{2}^\circ$ ) ahead of



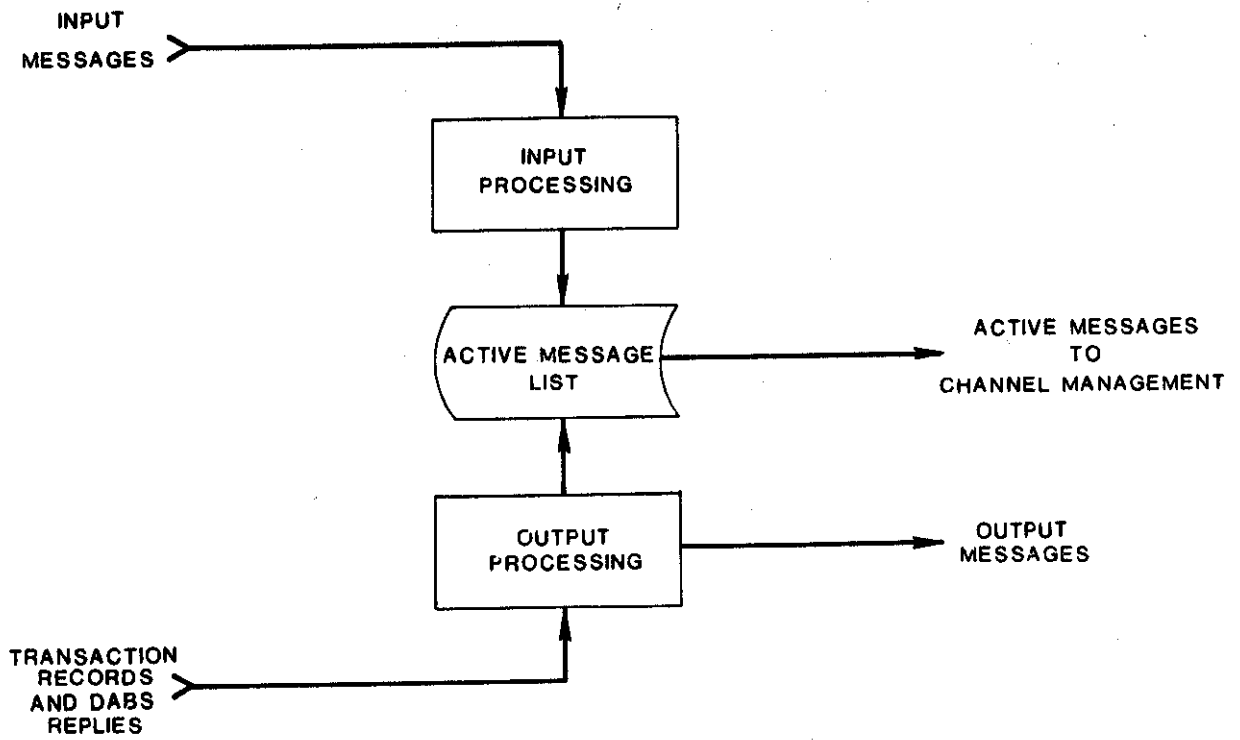

Fig. 3-18. Data-Link Processing.

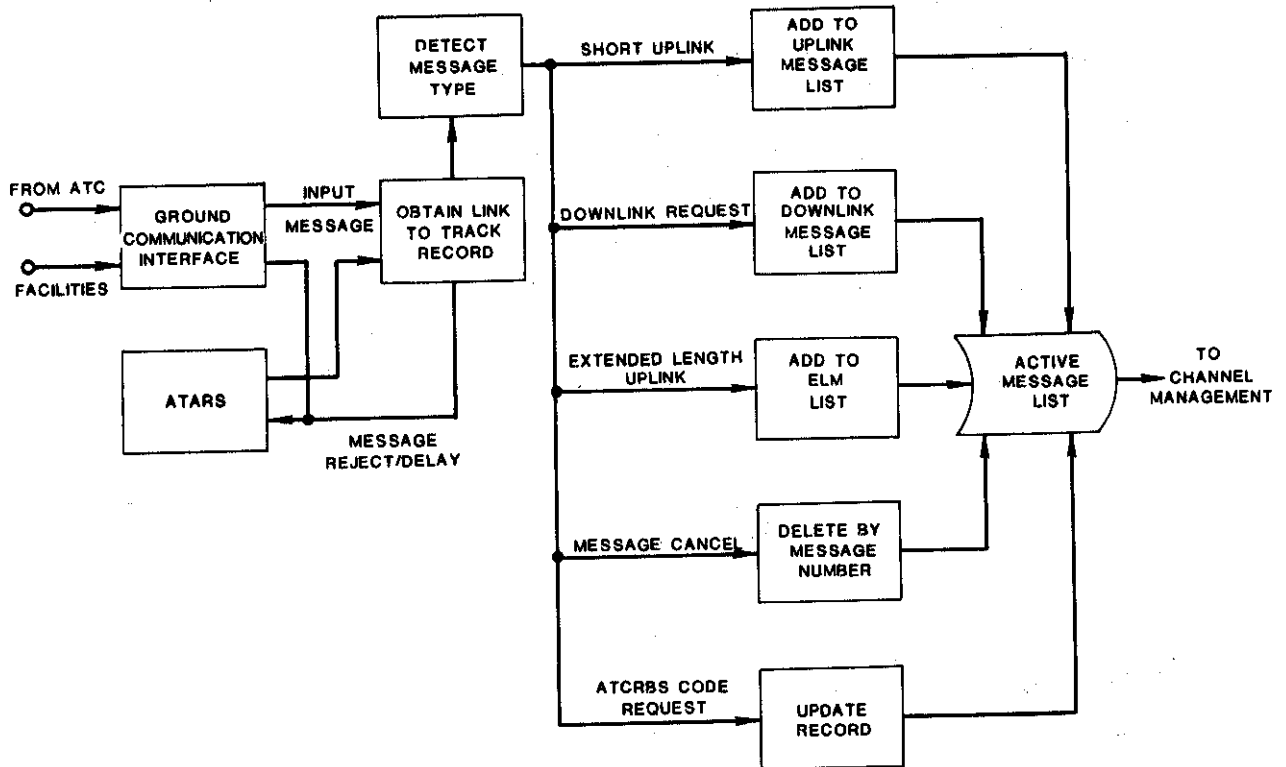

Fig. 3-19. Input Message Processing.

its azimuth at which the addressed aircraft will enter the antenna beam. A test is made to determine the status of the addressed DABS aircraft in the local surveillance file. If the DABS aircraft is not contained in the file, an immediate message reject notice is generated and sent to the message originator. If the DABS aircraft is in the file but in a fade condition, requests for uplink delivery will be accepted but the sender will be issued a message delay notice. The message type is detected and the active message list is updated. This updating takes place according to an implicit and a user defined priority. The implicit structure of data link processing and channel management places extended length messages at a lower priority than the shorter, standard messages. Within each of the two message categories, further priority assignment can be made at user option. If a message is flagged as priority, then it enters the active message list for the addressed aircraft ahead of any pending low priority messages of the same category (i.e., standard or extended length). A site adaptable "ATARS preference" parameter makes it possible to define an additional priority class. When used, ATARS preference causes ATARS generated standard messages to enter the active message list ahead of any ATC generated messages of the same priority.

#### Output Processing (Fig. 3-20)

DABS replies from the current scan are checked for indication of successful uplink message delivery and for requests for new air-to-ground message transfers. Downlink messages included in the replies are detected, flagged as complete, and routed to intended recipients as indicated by information stored in the active message list (for ground-initiated messages), or to all appropriate ground facilities (for pilot-initiated messages). The final task involves updating the list to reflect additions and completions this scan, and the generation of delivery notices.

#### NETWORK MANAGEMENT

DABS sensors exchange surveillance data to handoff targets between sensors and to maintain surveillance continuity and rapid target reacquisition in the event of a temporary link interruption. This multisensor coordination is directed by the network management function, operating under the control of the sensor coverage map. Network management also provides for continuity of surveillance and data link services in situations where adjacent sensors do not have a ground communications link.

An overall block diagram of the network management function is presented in Fig. 3-21. Once each scan, each DABS track is processed by coverage coordination to determine if a boundary crossing or a track state change has occurred. Either of these events will cause control message handling to initiate a sequence of messages. The former results in a flow of track data to the sensor whose boundary was crossed; the latter results in a request, or cancellation of a previous request, for surveillance data to fill in during a link interruption. Control message handling also processes network control messages from adjacent sensors and ATC facilities and retrieves or stores data in the surveillance file as required. If any adjacent sensor is not netted to

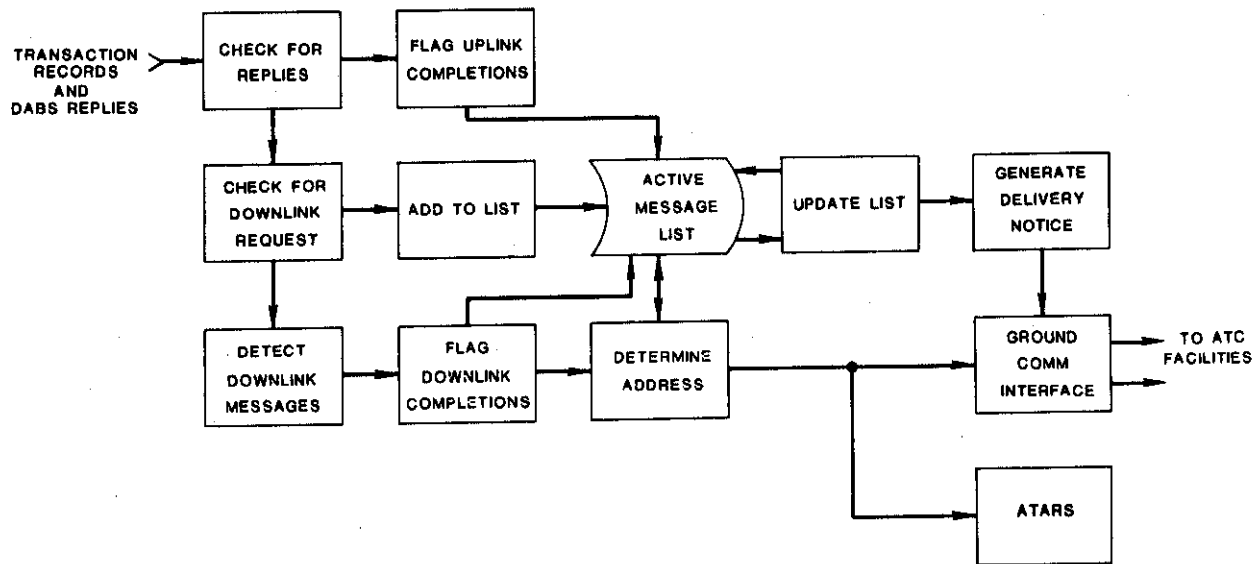

Fig. 3-20. Output Message Processing.

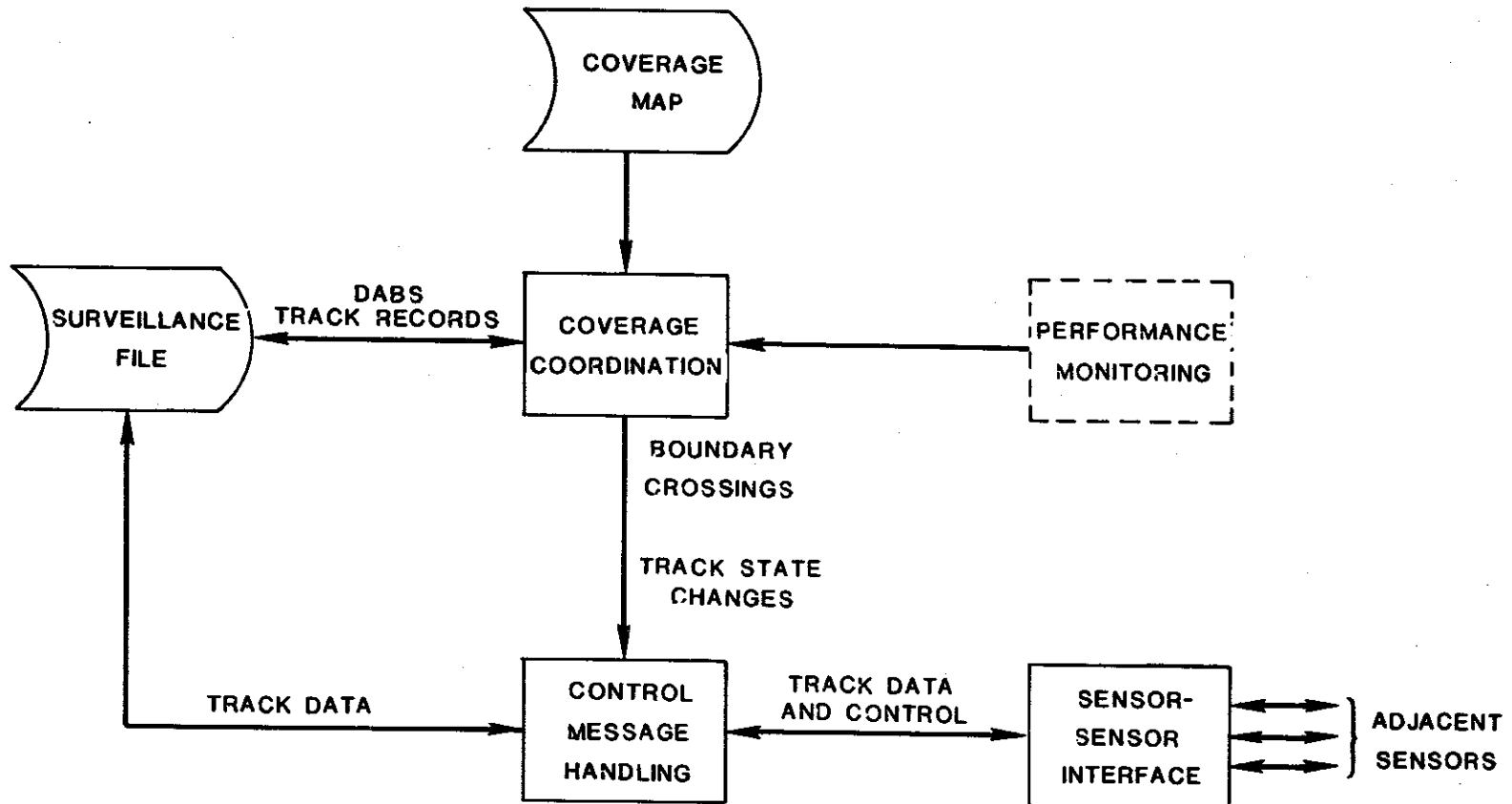

Fig. 3-21. Network Management.

the local sensor, coverage coordination routinely manages DABS lockout status in order to permit acquisition via all-calls.

### The Coverage Map

The extent and type of coverage to be provided by each sensor is controlled by a data file known as the sensor coverage map. In general, two major boundaries are defined by this map;

- (a) the maximum range at which the sensor is to provide surveillance coverage, and
- (b) the area where the sensor is assigned primary responsibility (for uncontrolled aircraft only).

The coverage map is implemented in a  $\rho - \theta$  grid as shown in Fig. 3-22. For each element of the grid, termed a cell, a sensor priority list is specified, with a lower altitude cutoff defined for each sensor. The position of a sensor in the list specifies its surveillance function in that cell; primary, secondary, or backup. Sensor coverage boundaries are thus defined by a change in sensor ordering between adjacent cells. For controlled aircraft, a message from an ATC facility assigning primary or secondary status has the effect of overriding the map designation.

Also stored for each cell are other geographically-defined data, such as the altimeter correction ( $\Delta H$ ) to be used in generating altitude echos.

In the event of a sensor failure, that sensor is flagged as inactive, effectively deleting it from the sensor priority list. In this way the primary and secondary coverage areas of active sensors are automatically enlarged to take over (to the extent possible) the area formerly serviced by the failed sensor. In the event of failure of sensor-to-sensor communications, the sensor affected is temporarily treated as non-connected. That is, aircraft are unlocked to DABS all-call interrogations at the surveillance boundaries of this sensor in order to permit acquisition by its normal all-call interrogations.

### Coverage Coordination

Figure 3-23 illustrates the elements of the coverage coordination sub-function for connected sensors. The current position of the track is used to determine the present cell index. If the cell index has not changed since the last scan, and no failure/recovery of an adjacent sensor has occurred, no further action on coverage assignment is done. Otherwise, the sensor priority list for this cell is retrieved from the coverage map, deleting those sensors that the performance monitoring function has declared to be in a failed state. The resulting sensor assignment is compared to the previous assignment (stored as part of the track record) to detect the occurrence of a boundary crossing. If one is detected, an indication is passed to control message handling to initiate the appropriate sequence of messages.

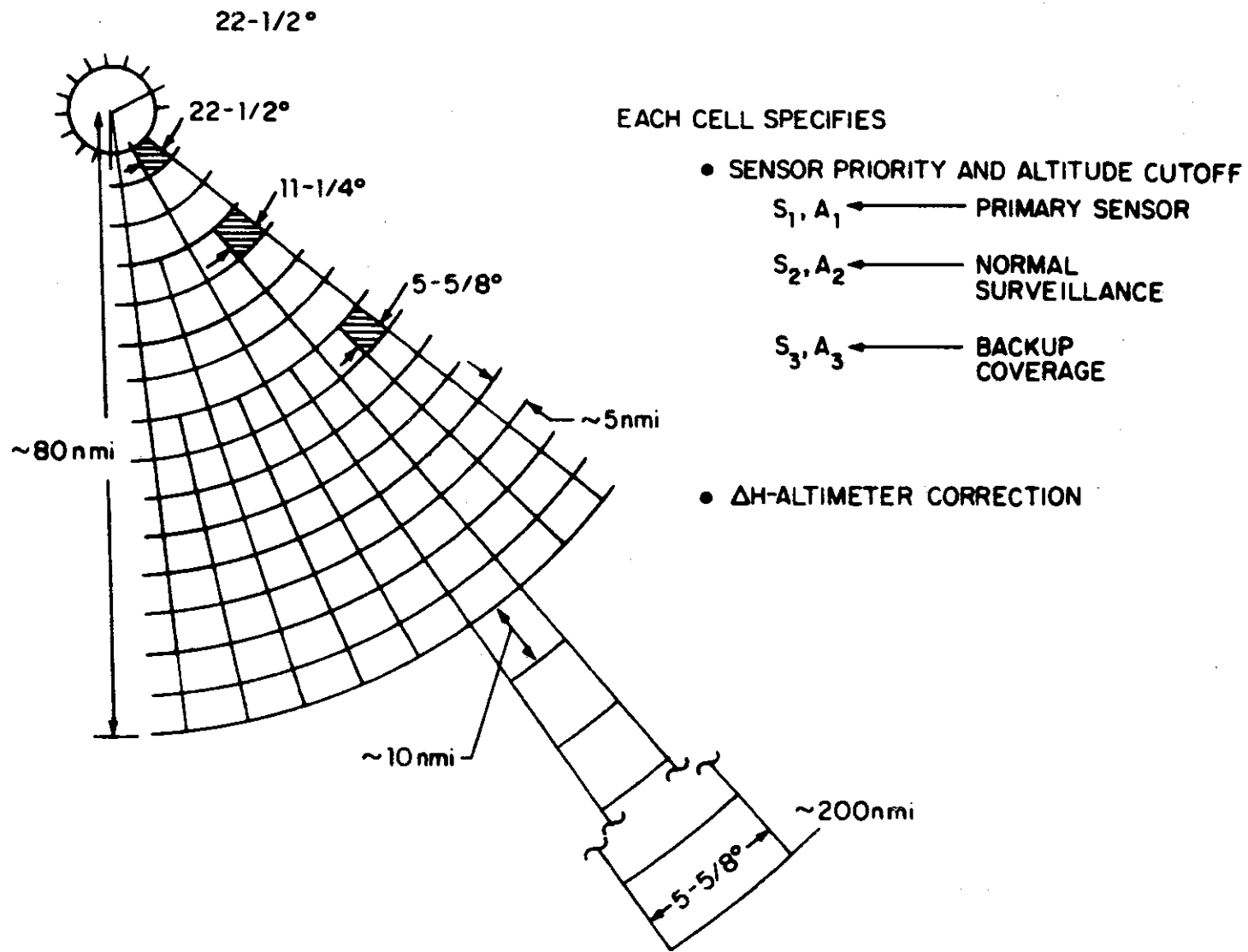

Fig. 3-22. Coverage Map Grid Structure.

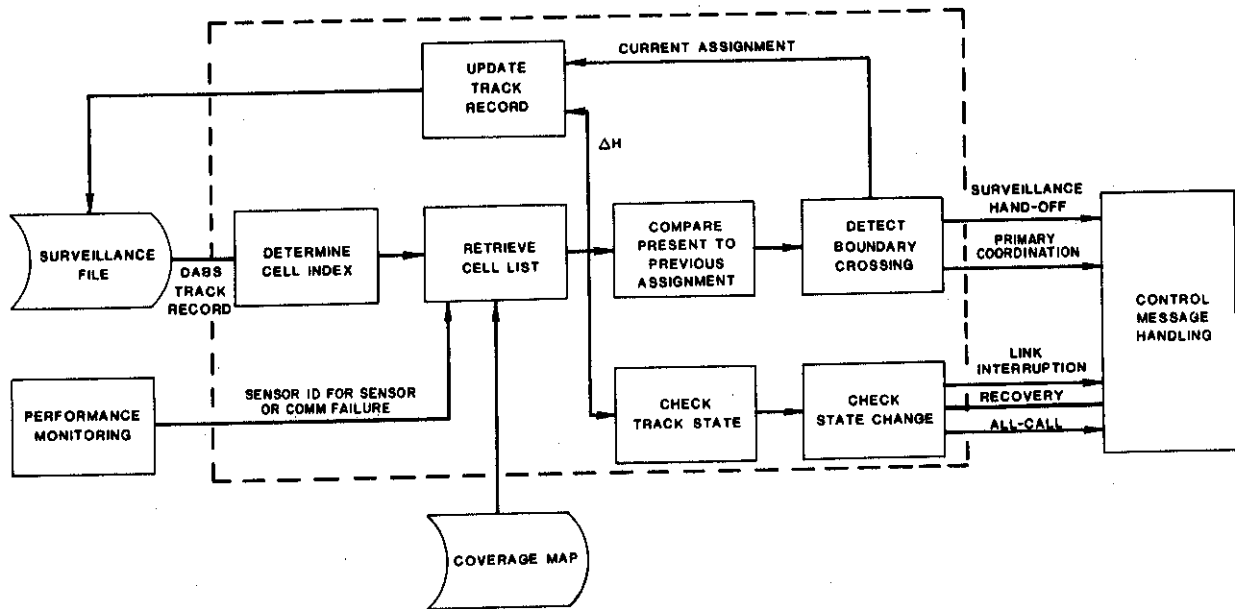

Fig. 3-23. Coverage Coordination.



The present track state is then compared to the previous state to detect the beginning or end of a link interruption. Again, an indication is passed to control message handling to begin or terminate the flow of adjacent sensor data. An additional check is made to determine if the track was just initiated as a result of the local sensor's all-call interrogations. If so, surveillance data on this track is disseminated to the other assigned sensor(s) in the cell by control message handling, using the same message sequence as for a surveillance boundary crossing.

Where the new cell data indicate a primary/secondary status different from the one in effect for an uncontrolled aircraft, a primary coordination message exchange is initiated. A typical primary coordination exchange involves a local sensor initiating a request for primary assignment to an adjacent sensor when an aircraft first enters the local sensor's primary coverage area. If the adjacent sensor has not as yet acquired the track then it will respond with a "primary approved" message. If the adjacent sensor has the aircraft in track and assigned primary (due to the overlapping primary assignment needed for continuous primary coverage) then it will send a "primary disapproved" message. The coordination is completed when the adjacent sensor's map no longer indicates primary status for this aircraft. The adjacent sensor sends a request for secondary assignment to the local sensor and assigns itself secondary when an "accept primary" response is received.

Storage in the track record of the current sensor assignment and cell data such as the  $\Delta H$  correction completes the cycle of activity.

#### Control Message Handling for DABS

Certain events cause a sequence of messages to be exchanged between DABS sensors. These events, and the resulting messages, are listed in Table 3-1.

#### Control Message Handling for ATRCBS

Messages on ATRCBS targets are limited to an exchange of track data on request for mode-C equipped aircraft. The sequence of ATRCBS control messages used to establish this exchange is similar to that shown in Table 3-1 for the DABS track state change event.

#### Non-netted Configuration

In configurations in which an adjacent assigned sensor is not connected to the local sensor (either permanently or temporarily because of communications failure), it is necessary to provide a means of surveillance handoff. This is done by intermittently unlocking each DABS aircraft to all-call interrogations for a few scans. The parameters for a cycle of unlock and lock periods are chosen so as to minimize possible interference while providing adequate opportunities for acquisition.

## Data Relay Mode

Provision is made for handling the case where more than one of a set of netted sensors can provide useful coverage to an ATC facility, but the facility is only connected to one of the sensors. In this case, the connected sensor can provide adjacent sensor surveillance data to the local ATC facility as needed to fill in for a temporary data loss due to an aircraft fade. Communications message delivery during a fade condition is handled automatically by the local sensor relaying the message to an adjacent sensor for delivery to the aircraft.

TABLE 3-1

### CONTROL MESSAGE HANDLING

<u>Event</u>	<u>Message Sequence</u>	<u>To/From</u>
Surveillance Handoff	Send Data Start to Send Track Data to Receive Cancel Request from Send Data Stop to	The New Active Sensor in the Cell
Track State Change	Send Data Request to Send Data Start from Receive Track Data from Send Cancel Request to Receive Data Stop from	The Other Active Sensor(s) in the Cell
All-Call Acquisition	Send Data Start to Send Track Data to Receive Cancel Request from Send Data Stop to	The Other Active Sensor(s) in the Cell
Primary/Secondary Coordination (for uncontrolled aircraft)	Send Request for Primary/Secondary Assignment to Receive Primary Approved/Disapproved/Accepted from	The Other Active Sensor(s) in the Cell

## AUTOMATIC TRAFFIC ADVISORY AND RESOLUTION SERVICE (ATARS)

Each DABS sensor includes an ATARS function that provides a pilot-oriented ground-based collision avoidance system based upon the earlier concept of Intermittent Positive Control (IPC). ATARS utilizes DABS surveillance data to generate its own aircraft track file and position predictions. From these, ATARS computes traffic and resolution advisories and delivers these to ATARS-equipped aircraft via the DABS ground-air data link. ATARS also sends controller alert messages to the appropriate ATC Facilities whenever a potential conflict involving a controlled aircraft is first detected and when a resolution advisory is sent to a controlled aircraft.

### ATARS Concept

Aircraft separation assurance is achieved by continuously providing pilots with traffic advisory information on the location of proximate and threatening aircraft and by issuing resolution advisories on an as needed basis. ATARS provides services to all equipped aircraft, both controlled and uncontrolled, in the en route and terminal environments served by DABS. ATARS resolution service is provided against all aircraft that are equipped with altitude reporting transponders. Traffic advisories are provided to ATARS equipped aircraft on Mode A and primary radar targets that are proximate in the horizontal plane. A single ATARS algorithm is used in both the en route and terminal environments; however, system thresholds and site adaptation parameters are dependent on the individual installation. In the en route environment DABS/ATARS uses the back-to-back antenna to effectively double the normal en route surveillance update rate.

### Interfaces

The interfaces ATARS uses to communicate with local sensor functions, adjacent ATARS functions, and ATC facilities are:

ATARS Input: ATARS receives input from (a) other functions in the local sensor, (b) the ATARS function at an adjacent sensor, and (c) the performance monitoring function. From other functions in the local sensor, ATARS receives its inputs via the following buffers:

- Surveillance Buffer: Local and adjacent sensor aircraft target reports.
- Nonsurveillance Buffer: Local and adjacent sensor data link information, Remote CIR data.
- CIR Buffer: Conflict Information Register (CIR) downlink data.

Data transmitted to the local ATARS function from adjacent ATARS are received directly from the sensor-to-sensor interface. Sensor status data from the performance monitoring function are sent to ATARS via message routing management.

ATARS Output: ATARS outputs ultimately go to (a) other DABS functions in the local sensor, (b) the ATARS function at an adjacent sensor, and (c) the ATC facility having control responsibility in the ATARS service area. Uplink data for local and/or adjacent sensor transmission on the ground-air link are sent to the message routing management function. ATARS sends conflict tables and other multi-site coordination messages for an adjacent ATARS function directly to the sensor-to-sensor interface. ATARS controller alert messages are routed to the appropriate sensor-to-ATC facilities communications channel.

### ATARS Processing

ATARS processing is primarily sector driven on a 22-1/2 degree (1/16 scan) sector. The major processing functions are described in the following paragraphs.

ATARS Tracking consists of two main subtasks: report processing, and tracking/track update. The general division of responsibility is that report processing reads the surveillance buffer, screens local and remote reports to determine if they are within a coarse ATARS service area map, starts new tracks, screens duplicate reports for a track on a hierarchical basis, and prepares the remaining reports for tracking/track update. Tracking/track update processing maintains a file of system tracks and selects particular target reports (those determined as usable by report processing) for track update, and stores these reports in the ATARS data base called the central track store (CTS). Smoothing and prediction uses the selected reports for production of fresh position and velocity updates. Estimates of the tracked aircraft position and velocity coordinates are then stored in the CTS.

Other files maintained by tracking include cross-reference file which contain information linking each aircraft in its corresponding track in the central track store. There is one file for DABS targets, and a second file for (a) Mode C ATCRBS targets and (b) non-Mode C ATCRBS/radar targets. An additional file called the X-initial list contains a list of tracks waiting to be placed on the X-list (a list of aircraft ordered by their X-coordinate) and therefore to be afforded ATARS service.

Nonsurveillance Buffer Processing reads the nonsurveillance buffer which contains, in individual lists, uplink delivery notices, data link capability notices, and any ATARS-ATARS messages including remote CIR data. These messages are processed once per sector.

CIR Buffer Processing reads the CIR buffer on a sector basis. This data is supplied to the rest of ATARS processing to allow through-the-transponder ATARS-to-ATARS coordination of conflicts, and ATARS-BCAS coordination of conflicts.

Coarse Screen Processing searches the ATARS data base for aircraft that are potentially in conflict with aircraft in the current sector. If system proximity thresholds are passed between a pair of aircraft a potential conflict pair is declared.

Conflict Detection Processing performs further checks on the potential conflict pair. If certain threshold criteria are met, the pair undergoes resolution processing immediately if both aircraft in the pair are in an area that is unambiguously under the control of the local ATARS function. However, resolution processing is deferred if one of both aircraft are in a seam area between the local sensor and an adjacent ATARS site. In this case, coordination for the resolution of the conflict is conducted with the adjacent ATARS function. The output of conflict detection processing consists of several flags indicating the threat level of the conflict and the necessary action to resolve the conflict by means of proximity, threat, or resolution advisories. If conflict detection processing determines that a resolution advisory is required, the master resolution subtask is called.

Master Resolution Processing selects the most effective resolution advisory for the conflict pair. Once appropriate resolution advisories have been determined, a controller resolution advisory notification is transmitted to the ATC facility for conflicts involving controlled aircraft. Resolution advisories are also delivered to data link message construction.

Data Link Message Construction Processing prepares uplink messages and formats them for transmission to the DABS message routing management function for delivery to the aircraft via the ground-air data link.

#### PERFORMANCE MONITORING

The ability of the sensor to perform its surveillance and communication tasks is continuously checked by the performance monitoring function (Fig. 3-24). Three categories of checks are performed:

- (a) Overall checks for proper surveillance and data-link operation.
- (b) Internal checks on the status of the sensor hardware and software.
- (c) External checks on the status of adjacent sensors and their ability to provide the local sensor with correct surveillance data.

The results of these checks are evaluated once per scan to determine the status of the sensor. Possible status conditions are:

- (a) Normal operation (condition green) - no abnormal indications.
- (b) Marginal operation (condition yellow) - operational but becoming marginal.
- (c) Failed state (condition red) - sensor operation ceases.

Declared sensor status is reported once per scan to the ATC interface along with condition codes that define the reason(s) for the yellow or red condition. A simplified version of this message indicating only the declared condition is sent to all adjacent sensors.

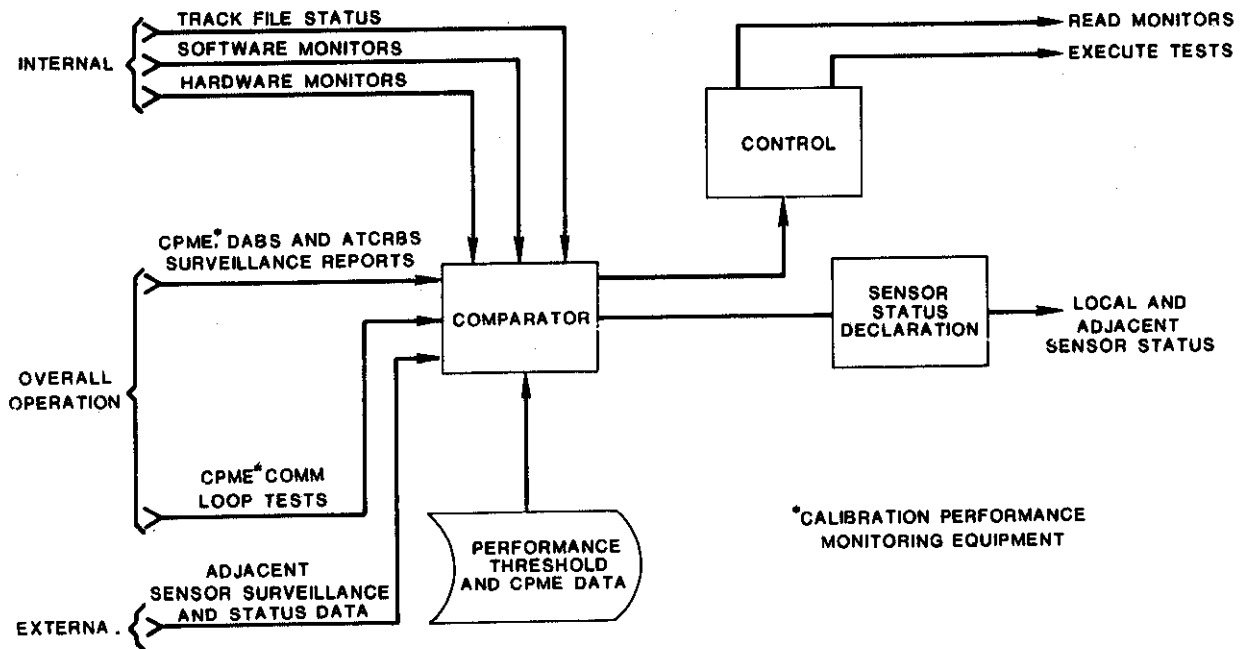

Fig. 3-24. Performance Monitoring.

The sensor performance monitoring function interfaces with the FAA's remote maintenance monitoring subsystem (RMMS). The RMMS also receives the sensor status message and, in addition, has the capability of remotely controlling sensor functions such as initial loading and start up, parameter modification and the switching of redundant elements.

#### Calibration Performance Monitoring Equipment (CPME)

The CPME is a transponder-like device, several of which are deployed in close proximity to each sensor, as shown in Fig. 3-25.

CPME's serve as the basis for the overall operational surveillance checks by providing replies from a "target" with a known identification and position (range, azimuth, altitude). Overall operational communication checks are performed by loop tests with the CPME. In these tests an uplink test message delivered to the CPME causes it to initiate a downlink message with the same text as contained in the uplink message.

The ability to obtain surveillance data from an adjacent netted sensor is also checked using the CPME. In this case, the local sensor requests data on the CPME of an adjacent sensor. Data received in response to the request are checked against the stored data to verify correct delivery.

#### MESSAGE ROUTING MANAGEMENT

Message handling between sensor functions and the external interfaces is performed by the sensor message routing management function. The principal flow of messages is from the external interface to the local ATARS, network management, performance monitoring and data link processing functions. In addition, message routing management also provides the interface between the sensor surveillance and communications functions and the local ATARS.

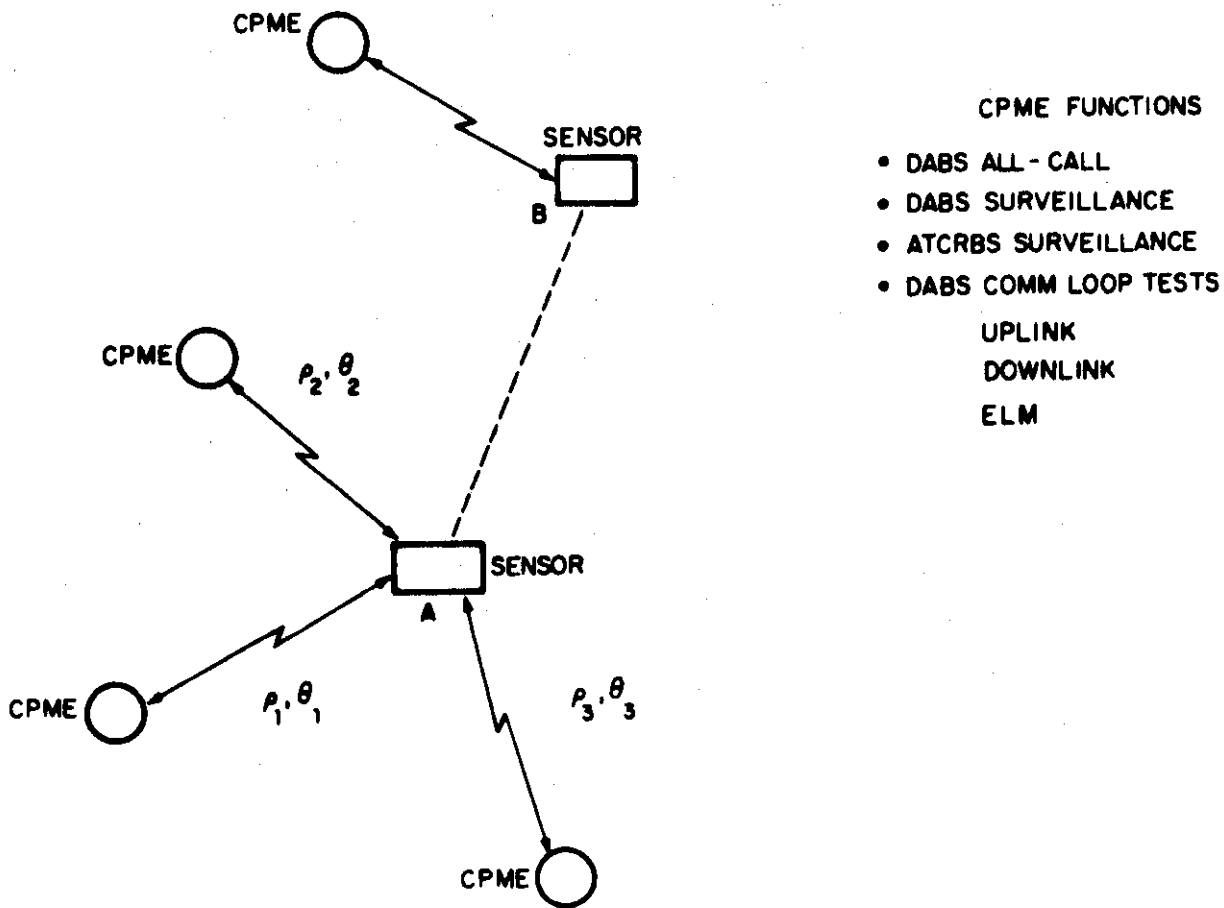

Fig. 3-25. Calibration and Performance Monitoring Equipment (CPME).



## CHAPTER 4

### THE DABS TRANSPONDER

The DABS transponder receives and decodes ATCRBS and DABS interrogations, recognizing which DABS interrogations are addressed to it\*. Based upon the type of interrogation, and the contents of the control field in the DABS interrogation, the transponder formats and transmits the appropriate ATCRBS or DABS reply. As in the case of an ATCRBS transponder, inputs from an encoding altimeter are required for altitude reporting.

For data-link transactions, both standard and ELM, the transponder acts as a modem. Uplink messages, once verified\*\*, are passed on to external display devices. Downlink messages are accepted from external message input devices, encoded by the addition of parity check bits, and transmitted. The transponder does not interpret or modify in any way the contents of such messages.

By keeping most data-link functions external to the transponder, the complexity and cost of the basic transponder can be kept at the minimum required for its surveillance functions. The additional costs associated with the data-link functions are incurred only by users desiring those services.

DABS transponders may be equipped with a standard message interface, providing outputs to the ATARS display and other standard message input/output devices. Only transponders used in installations with data link devices will have the additional logic and control functions required for accepting and transmitting extended-length messages.

#### The Pilot Interface - Controls and Indicators

Figure 4-1 depicts the controls and indicators of a DABS transponder as they might be arranged on the front panel of a general aviation transponder. (The same functions would be provided for an air carrier transponder, but as part of a remotely-mounted control head.) All normal ATCRBS controls and indicators are retained, including:

- 4096 code selector
- Ident button
- ATCRBS reply indicator
- Power switch

---

\*Each DABS transponder must be able to recognize two addresses: the discrete address set into it; and the "all-ones" address, used in DABS-only all-call interrogations and one-way, broadcast transmissions.

\*\*Recognition of its address is implicit verification that the contents of the interrogation were correctly decoded.

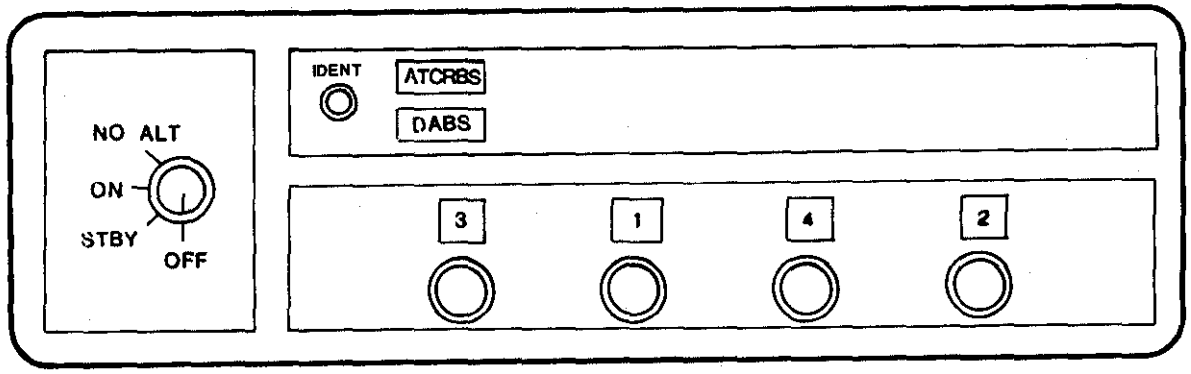

Fig. 4-1. Transponder Panel.

In the "ON" position of the power switch, altitude reports are included in mode C and DABS replies. A "NO ALT" position is included to inhibit altitude reporting in the event of an altitude encoder failure.

An additional function included for DABS is the DABS indicator which is illuminated whenever the transponder has been discretely interrogated within a fixed time (nominally 16 seconds, corresponding to the period of a few scans of an interrogator antenna), thus indicating that the transponder is currently on the roll-call of a DABS interrogator.

Each time the pilot changes the transponder's 4096 code an alert code is automatically set in the next DABS reply. The interrogator then reads out the squawk number which possibly could report an emergency condition. This scheme allows the 4096 code to be used for limited air-to-ground communication. The alert code is transmitted to the ground for 16 seconds unless the 4096 code set by the pilot indicates an emergency in which case the transmissions persist until the emergency code is removed by the pilot.

### Performance Characteristics

The performance characteristics of a DABS transponder are similar to those of an ATCRBS transponder designed for the same class of service. In fact, when operating in the ATCRBS mode (receiving and replying to ATCRBS interrogations), the DABS transponder conforms to all requirements of the relevant ATCRBS transponder TSO. Power output and sensitivity requirements for DABS transponders are as follows:

	<u>General Aviation</u> <u>below 15000 ft</u>	<u>Air Carrier</u>
Minimum Power Output	18.5 dBW	21 dBW
Maximum Power Output	27 dBW	27 dBW
Sensitivity	-74 ±3 dBm	-74 ±3 dBm

The values for sensitivity and power are measured at the antenna end of the cable between the transponder and antenna.

Two important performance characteristics peculiar to the DABS transponder are:

- (a) The DABS reply delay (the time between the sync phase reversal in the DABS interrogation and the beginning of the reply) is 128  $\mu$ s. This provides sufficient time for the transfer of the message contents of the interrogation to an external display device before beginning transmission of the reply.
- (b) In order to enhance DABS link reliability in the presence of interference from ATCRBS interrogators, the DABS transponder is required to recover its sensitivity rapidly following the receipt of an ATCRBS interrogation to which

it does not reply, and to decode DABS interrogations in the presence of interfering pulses whose amplitudes are at least 6 dB below that of the DABS interrogation.

### Block Diagram

The principal elements of the DABS transponder, and their interconnection, are depicted in Fig. 4-2. Many elements are similar or identical to the corresponding elements of an ATRBS transponder. In particular, the RF units, comprising the receiver, transmitter, and modulator, are essentially identical to the corresponding ATRBS units.

### Diversity

All aircraft types exhibit nulls in certain directions in their transponder antenna patterns due to airframe shielding. While these nulls are generally confined to angles above the horizon, and thus do not seriously affect the ground-to-air link, they can cause degradation of the link when the aircraft is in other flight altitudes. These nulls can cause failure of the air-to-air link for the Beacon Collision Avoidance System (BCAS).

In order to maintain adequate BCAS link reliability all aircraft will be equipped with a diversity transponder. Two antennas located so that at least one is visible from any direction, are connected to the transponder. Probably the simplest form of the diversity transponder is one which employs two receivers, selection logic, and a switch to connect the transmitter to either antenna (Fig. 4-3). The selection logic examines the interrogation as received on each antenna, selects the stronger signal and switches the transmission to the corresponding antenna for the reply.

### Data Link Interfaces

DABS transponders used for data link transactions may have two types of interfaces.

Standard Message interface: If the transponder is intended to transfer data in both directions using the Comm-A and the Comm-B formats, the interface must be capable of supporting all of the requirements of the Comm-B air-to-ground message protocol. One feature of this protocol is that it requires the transponder to reply to an interrogation with data which is designated or selected by the contents of that interrogation. This requirement can be met in either of two ways:

- a. The transponder can be designed to buffer the content of the air-to-ground data link messages internally, or
- b. The transponder can be equipped with a data interface which transfers the contents of an interrogation out of the transponder before the reply is generated so that these contents to be used by an external device to select the appropriate data for inclusion in the reply.

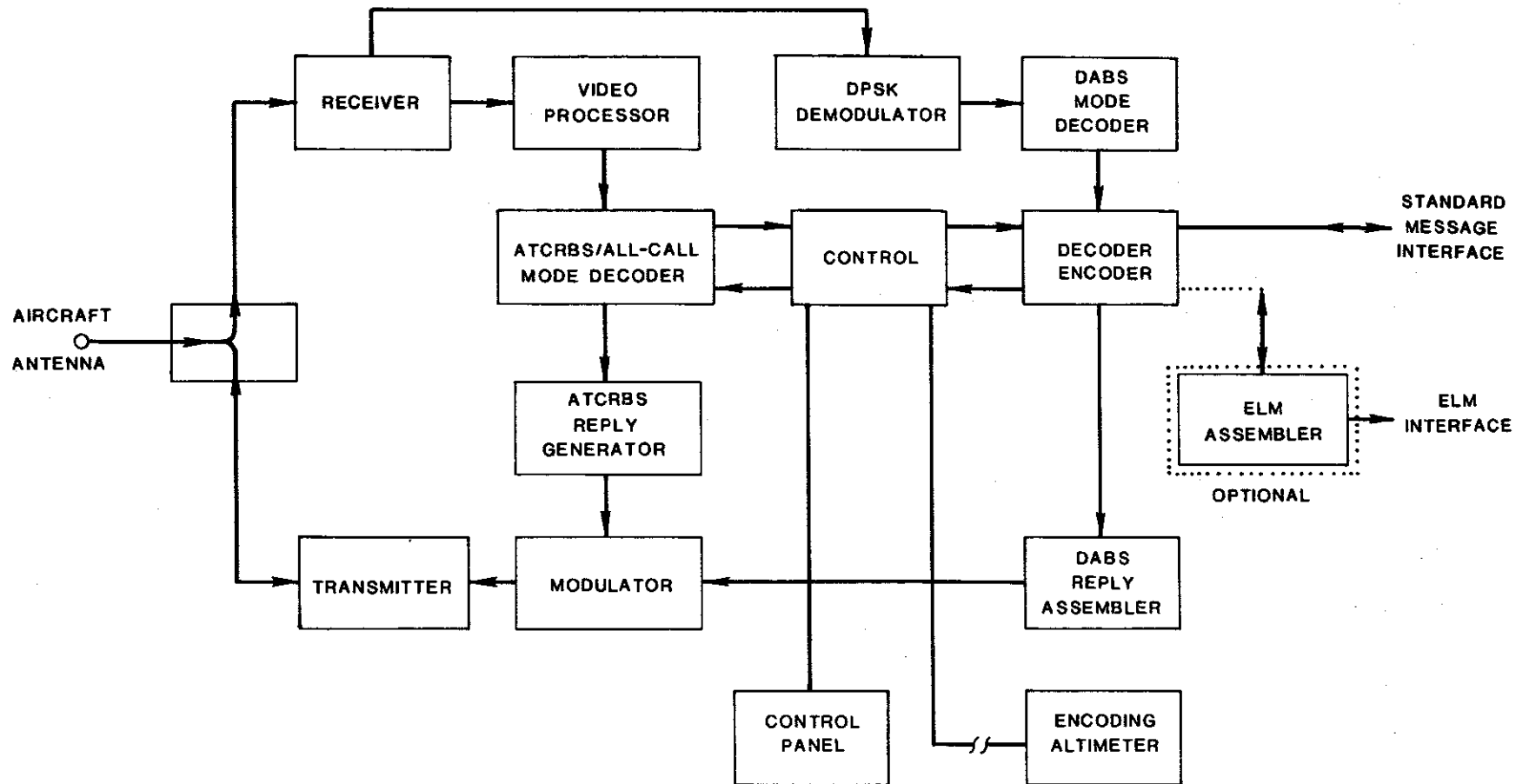

Fig. 4-2. DABS Transponder.

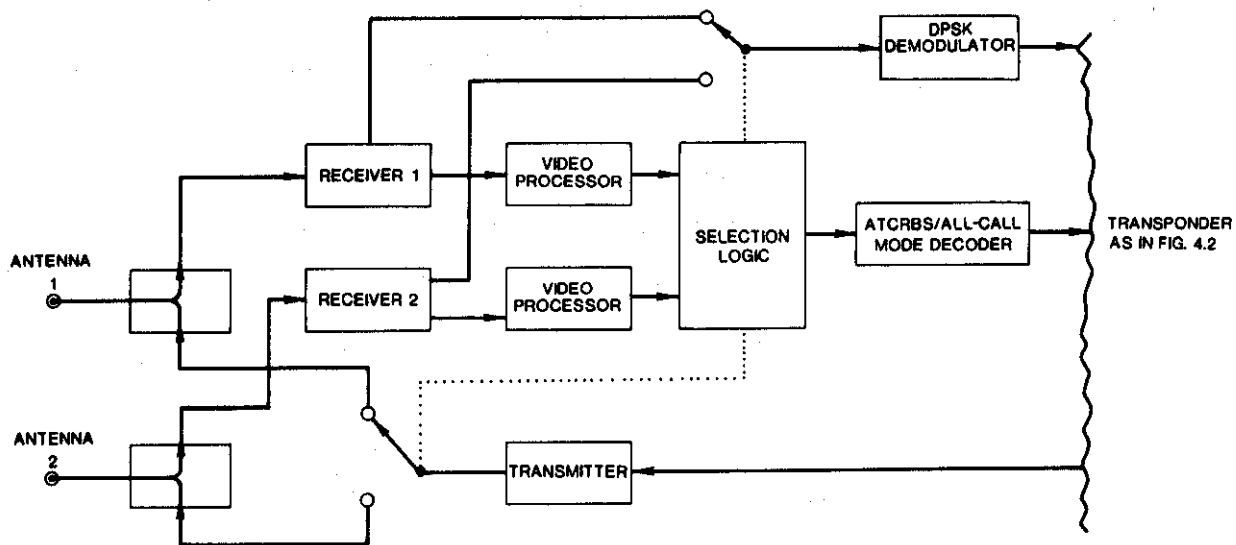

Fig. 4-3. Diversity Transponder.

The second type of interface is designated as a "real time" interface. It has the advantage that the necessary control logic and data buffers need not be included in the transponder. A further advantage is that multiple data peripherals can be accommodated without modifying the transponder in any way.

A practical realization of a real time interface has been employed in experimental DABS transponders. Known as the "standard message interface", it consists of a unidirectional clock line and a bidirectional data line (similar to the two-way serial bus used in conventional computer interfaces). The data rate in either direction is 1 Mbps. The data line is a differential, 3-state line, allowing bidirectional party-line operation. Any one of the devices attached to the data line (including the transponder) may drive the line at the appropriate time. The clock line, which is a two-state line since it is driven only by the transponder, allows I/O devices to time their operations so that they extract data from the data line at the proper time and so that they may merge data into the reply data stream at the appropriate time.

Fig. 4-4 is a timing diagram for the standard message interface. After the uplink transmission has been verified, the entire uplink message block, including all control fields but excluding the parity field, is transferred out over the interface. This allows flexibility for expansion to additional display and readout functions. Data to be transferred into the interface are synchronized so that they can be merged into the downlink transmission without buffering.

A take-over feature is provided such that an attached device can sense the format and content of an interrogation for which the transponder may not have the necessary reply capability because this new format may not have existed at the time of transponder construction. If the attached device generates a take-over pulse, the transponder lets the attached device generate the complete downlink format for the reply.

Extended-Length Message Interface: A transponder equipped for extended length message operation is capable of receiving, verifying, storing and acknowledging an uplink ELM transmission and also may be capable of assembling and transmitting an ELM downlink message. The content of an ELM message enters and leaves the transponder via an interface tailored to the data handling system of the aircraft.

#### Flight Identification Data

All aircraft employ a flight identification code for air traffic control purposes. Some aircraft (usually general aviation) employ the aircraft registration number which is painted on the aircraft. Other aircraft (principally those used for air carrier and military flights) employ variable flight identification codes based on the commercial flight number or the military call sign.

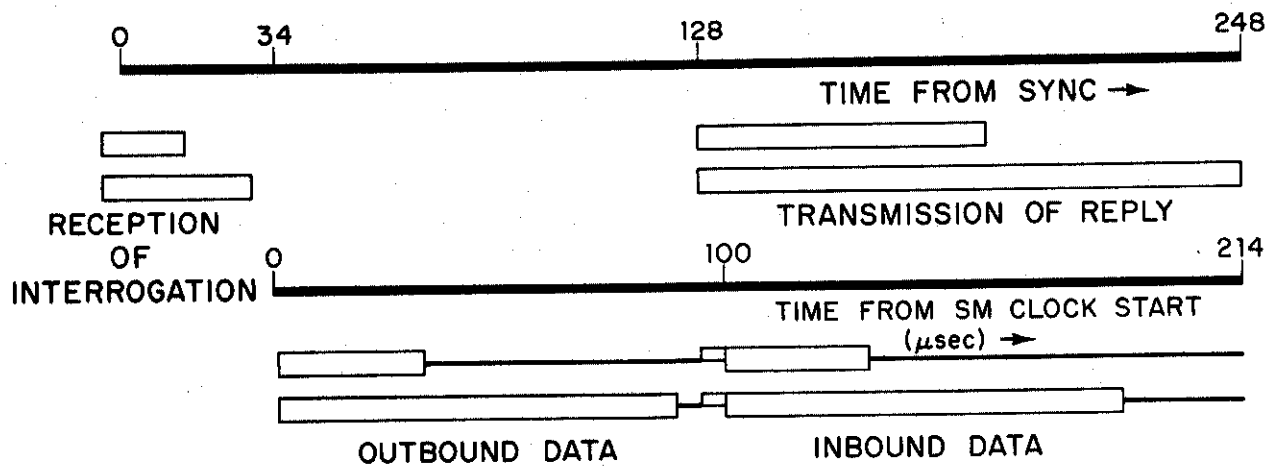

Fig. 4-4. Standard Message Interface Timing Diagram.



DABS transponders with Comm-B capability have provision for automatic reporting of this flight identification data. General aviation aircraft will permanently report the registration number. Other aircraft will employ a pilot input device to allow manual selection of the identification code for each flight. Codes consisting of up to several alphanumeric characters (42 bits) can be used. It is not anticipated that these codes will be related to the discrete DABS address code assigned to the transponder.

## CHAPTER 5

### PERFORMANCE

To adequately support an increasingly automated air traffic control system, DABS must provide reliable and accurate surveillance and data link communication for large numbers of aircraft. This chapter summarizes three particularly important aspects of DABS performance: link reliability in the presence of interference and fading, the azimuth measurement accuracy achievable with off-boresight monopulse, and the target capacity of a sensor using roll-call interrogation.

#### LINK RELIABILITY

The term link reliability is used to denote the probability of a successful link transaction such as a surveillance update or delivery of a data-link message. Limitations on link reliability are primarily due to interference and fading. This section summarizes these effects, illustrating the link reliability achievable under various typical conditions.

#### Link Power Budget

Table 5-1 gives DABS link power budgets for an aircraft at 50 nmi range and  $0.5^\circ$  elevation angle, and using a typical antenna for a terminal interrogator. Two uplink power modes are shown. Most interrogations are transmitted at low power to minimize uplink interference. In the high power mode the uplink and downlink have essentially equal fade allowances, and this equality continues to hold at all other ranges and elevation angles.

#### Interrogator Antenna Lobing

The character and magnitude of ground-reflection-induced vertical lobing for interrogator antennas having different rates of lower-edge cutoff are illustrated in Fig. 5-1. Vertical lobing depends on, among other things, the extent of flat ground in the vicinity of the antenna; the case represented in Fig. 5-1 is moderately severe in this respect, although not unusual. Oscillatory behavior of the pattern is evident, with the worst fades occurring at about  $1^\circ$  in elevation. Moderate changes in antenna height will shift the frequency of this oscillation within approximately the same envelope. The smaller null-depth of an antenna having a vertical pattern with sharp lower-edge cutoff is evident (Refs. 8 and 12).

#### Aircraft Antenna Fading

Aircraft antenna fading is illustrated in Fig. 5-2, based on scale model measurements (Refs. 9, 14, 15, 16, 17). Each curve shows the probability of fade greater than a given magnitude for a particular type aircraft in a particular phase of flight (level or turning). The data in this figure are shown in separate plots according to whether or not the aircraft are equipped with antenna diversity and whether or not they are in straight or turning flight.

TABLE 5-1

## DABS LINK POWER BUDGET (TERMINAL SENSOR)

PARAMETER	UPLINK			DOWNLINK
	HIGH POWER MODE	LOW POWER MODE		
Transmitter Power	59 dBm	50 dBm		57 dBm
Coupling Loss, Sensor to Antenna		-1 dB		
Coupling Loss, Transponder to Antenna		-3 dB		
Ground Antenna Gain		21 dB		
Peak Elevation Factor (0.5 nmi)		-5 dB		
Aircraft Antenna Gain (nom)		0 dB		
Path Loss	Free-space (50 nmi)	-132 dB	-132 dB	-132.5 dB
	Atmospheric	-0.5 dB	-0.5 dB	-0.5 dB
Received Power	-61.5 dBm	-70.5 dBm		-64 dBm
Minimum Triggering Level	-77 dBm	-77 dBm		-79 dBm
Nominal Margin	15.5 dB	6.5 dB		15 dB

68-ft ANTENNA HEIGHT, 15,000-ft FLAT GROUND

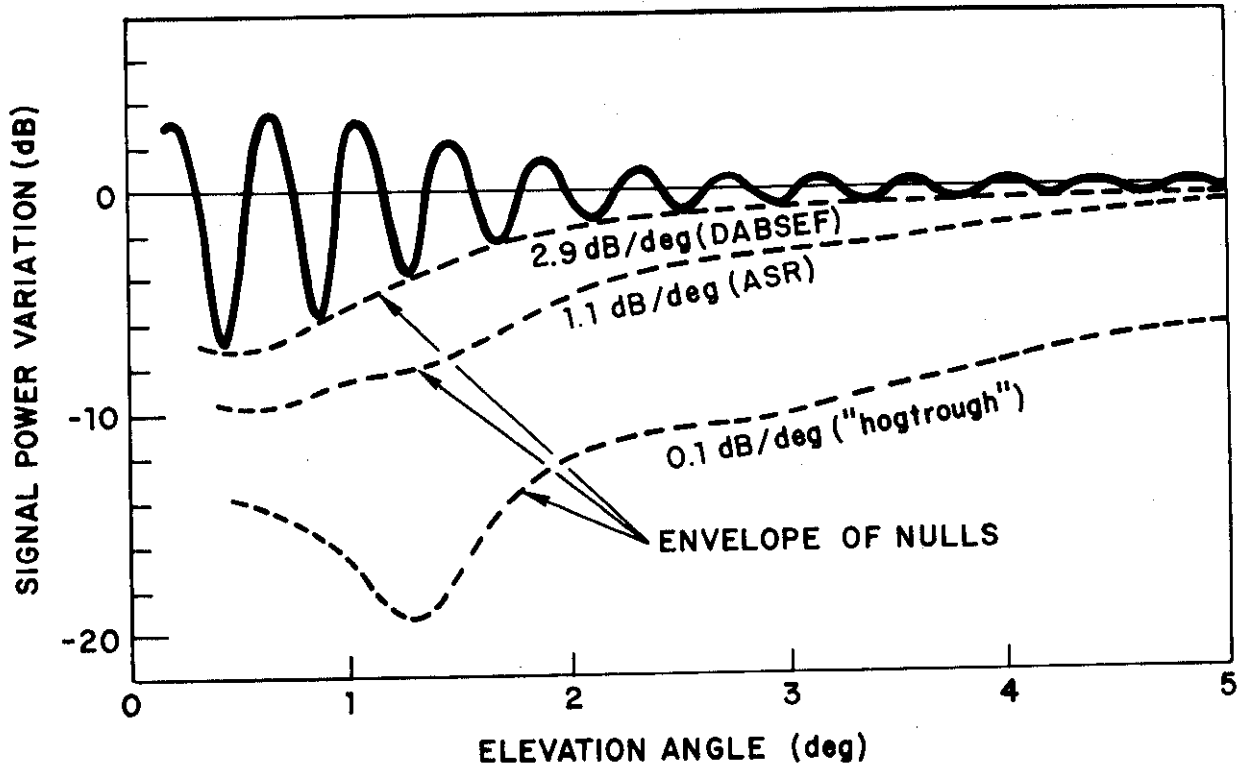

Fig. 5-1. Vertical Lobing.

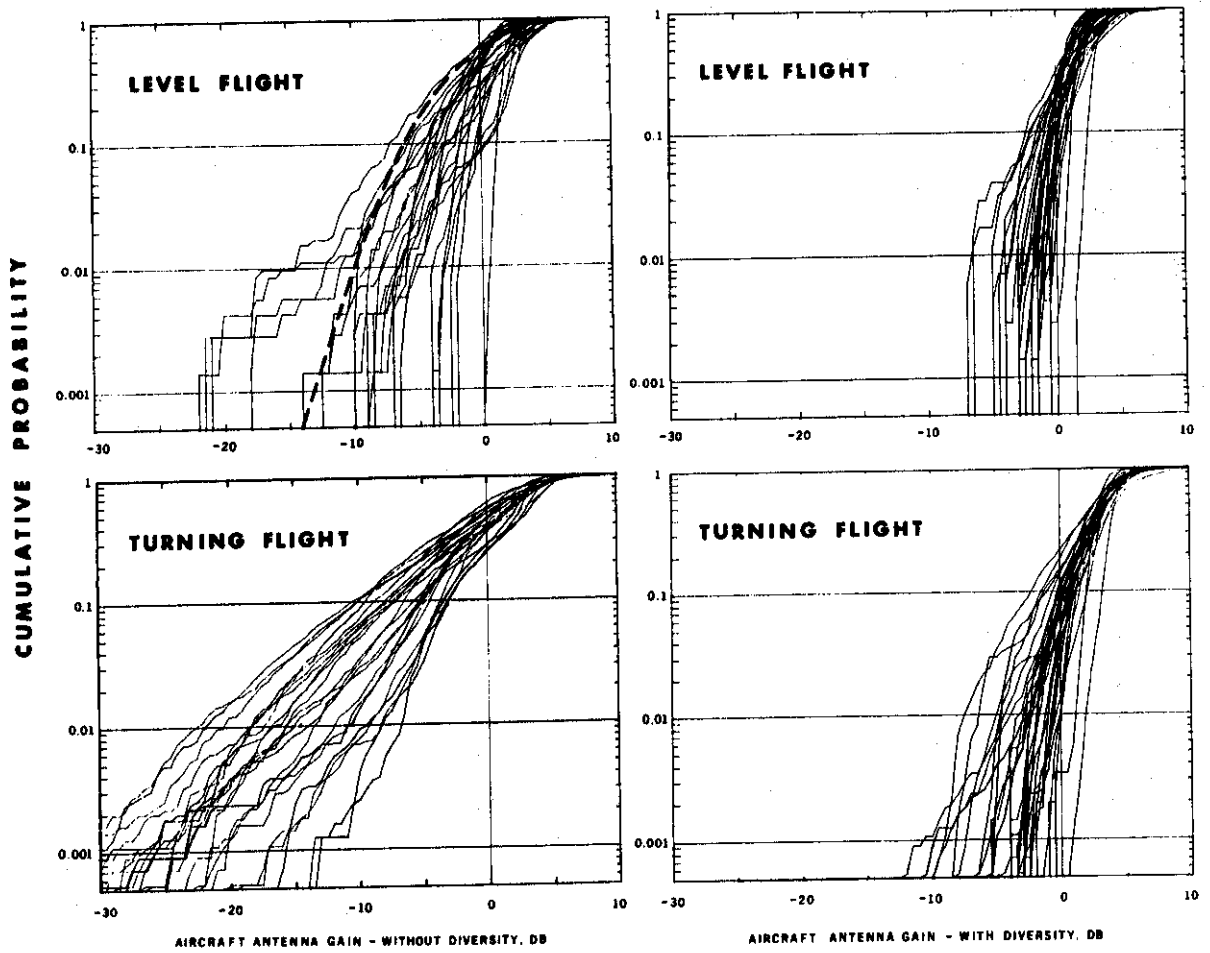

Fig. 5-2. Aircraft Antenna Fading.

It is evident that there are substantial differences among various aircraft types, and for the system to be tolerant to those aircraft-to-aircraft differences and still provide useful levels of link reliability, it is necessary to have at least 10 dB power margin just for aircraft antenna fading.

### Interference Effects

Interference effects on link reliability are illustrated in Fig. 5-3. This figure shows miss probability for a single interrogation/reply versus received signal power level with and without interference. A heavy ATCRBS interference environment is assumed, representative of the interrogator and traffic densities predicted for the Northeast Corridor in the mid-1980's time period.

At nominal received power levels, the round-trip miss probability due to interference is only a few percent. However, link fades, when they occur, cause power to drop and miss probability to rise substantially. For example, when received power drops to a few dB above the "minimum triggering level", roundtrip miss probability increases to about 40% (the bulk of this increase being due to the large amount of interference which exceeds a signal of this amplitude).

Since to a good approximation the occurrence of interference is independent from one try to the next, the ability to make multiple attempts in the event of a miss (adaptive reinterrogation) can substantially reduce its effect. The residual miss probability of a maximum of five tries is shown in Fig. 5-3. The miss probability with interference is now approximately the same as without, i.e., with noise alone. With adaptive reinterrogation, therefore, link reliability is determined by fade statistics rather than interference statistics; to a good approximation, the link reliability is the probability that fading is no worse than the link margin (Refs. 10 and 11). Furthermore, since reinterrogations, if any, are transmitted in the high-power mode, it follows that link reliability is determined almost entirely by the link budget in the high-power mode.

### Net Link Reliability

Combining fade statistics with the available link margin leads to an estimate of link reliability in various cases. In the example considered above (Table 5-1), at 50 nmi and 0.5 deg. elevation, the nominal margin is 15 dB, which must be sufficient to offset adverse deviations due to vertical lobing, aircraft antenna fading, transponder sensitivity deviations, etc. Allowing 7 dB for vertical lobing and transponder parameters, the remaining 8 dB when applied to the "typical" aircraft characteristic marked in Fig. 5-2 results in a link reliability of about 99% for straight flight, non-diversity.

Similar calculations have been carried out for numerous values of range and altitude, leading to the results shown in Fig. 5-4. These calculations are more elaborate than the simple calculations given above: the model includes a population of transponder powers and sensitivities (over the tolerance

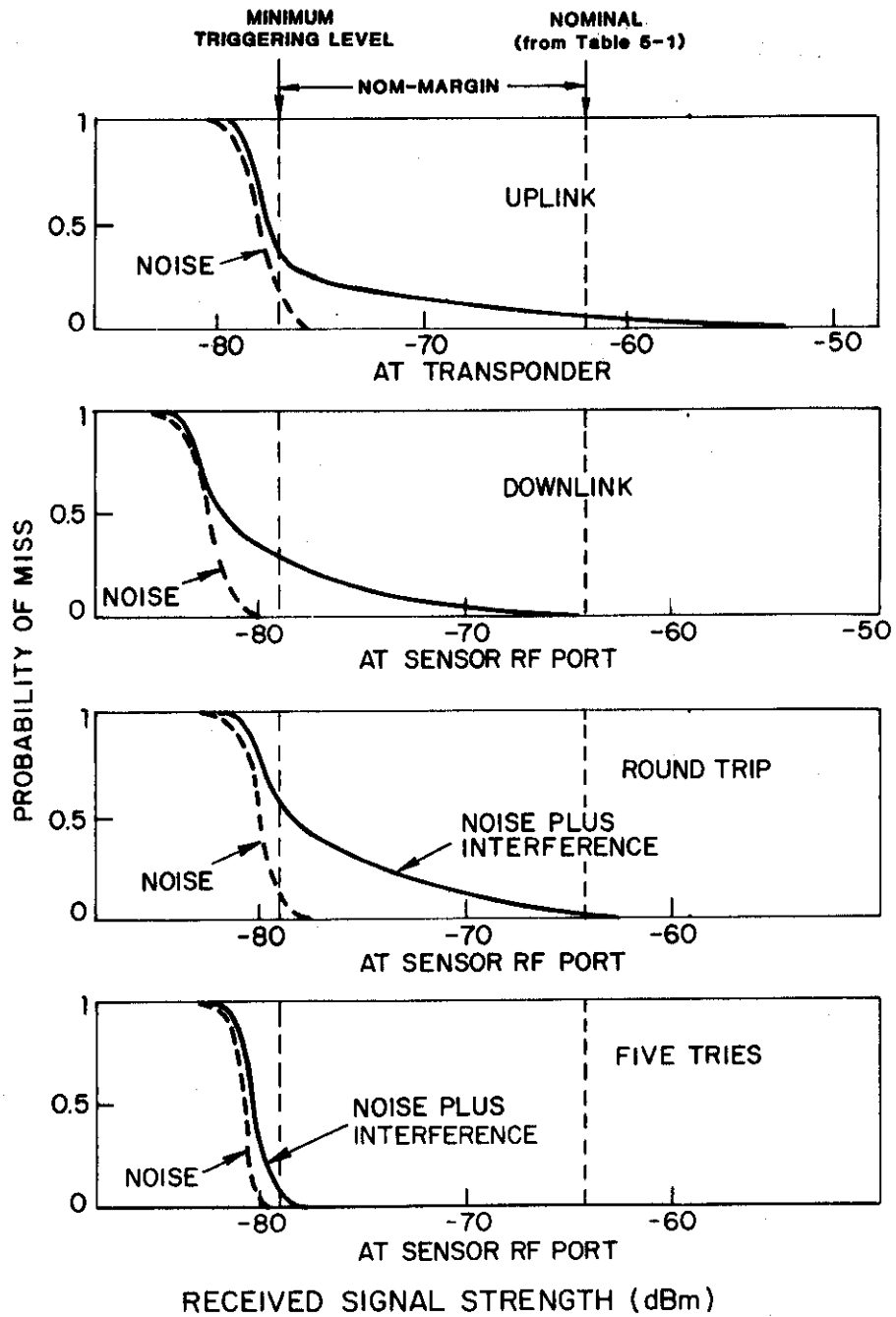

Fig. 5-3. Miss Probability.

**NOTE:** Two Scan Link Reliability  $LR_2$  = Fraction of Aircraft for Which Surveillance Update is Successful at Least Once in the Next Two Scans.

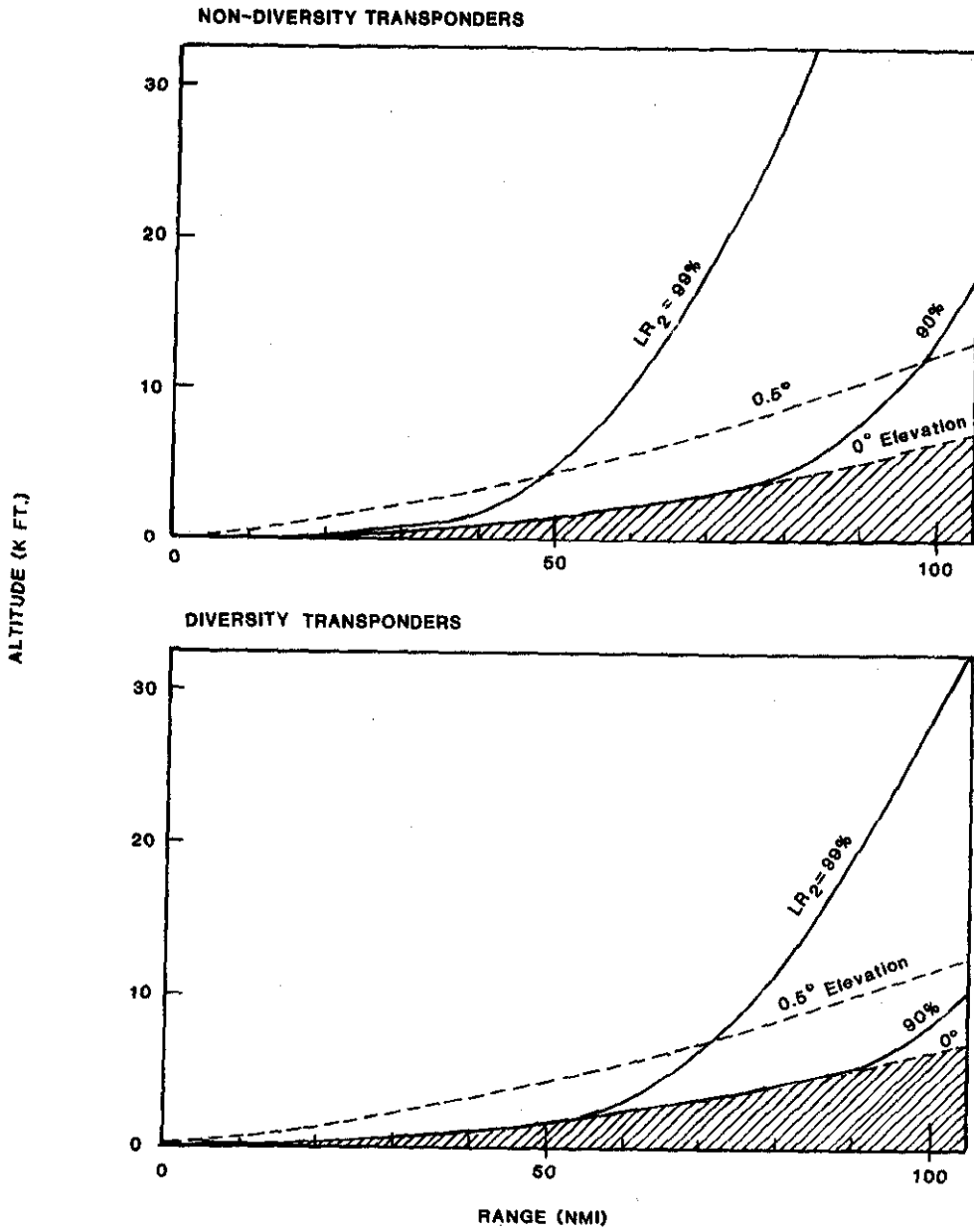

Fig. 5-4. DABS Link Reliability for a Terminal Sensor.



ranges given in the DABS National Standard), statistical representation of vertical lobing, and a mix of turning and straight flying aircraft. The two-scan link reliability plotted was adopted because it is a more useful figure of merit for characterization of a DABS sensor due to the following: (1) in turning situations the geometry is continually changing with time, the result being that it is somewhat unlikely for a miss to occur for two scans in succession; (2) in most contexts, the adverse consequences of a single missed scan are not severe relative to the consequences of two missed scans in succession.

Results are given in Fig. 5-4 separately for diversity equipped aircraft and non-diversity aircraft. Note that performance degrades at longer ranges, but a useful level of performance is maintained out to about 100 nmi even for the terminal sensor. In the case of an enroute sensor, antenna gain is typically 4 dB more than the example considered here, and thus comparable levels of link reliability are provided out to ranges greater by a factor of about 1.6.

In summary, reliable link operation is possible in a severe interference environment, the level of reliability being set primarily by fade statistics.

#### MONOPULSE PERFORMANCE

As described in Chapter 3, the monopulse receiver-processor makes an estimate of the off-boresight angle for each received pulse of the ATCRBS or DABS reply, and then combines the individual measurements to provide a single estimate for the whole reply.

The four major sources of error in the monopulse estimate are:

- (a) receiver noise,
- (b) processor inaccuracy,
- (c) variation with elevation angle, and
- (d) multipath and interference.

#### Receiver Noise

The effect of receiver noise on rms azimuth error is illustrated in Fig. 5-5 for an interrogator antenna having a  $\Delta/\Sigma$  beamwidth of  $4^\circ$ , i.e.,  $\Delta/\Sigma = 1$  at  $\pm 2^\circ$  off-boresight. For pulse signal-to-noise ratio (SNR) as low as 20 dB, a few dB above the operating threshold of the interrogator receiver, the rms azimuth error on each pulse is less than  $0.2^\circ$ . Averaging over  $N$  pulses in a DABS reply, or in one or more ATCRBS replies from the same target, will reduce the noise-induced rms error of the overall measurement by  $\sqrt{N}$ . Note that the azimuth error for a given signal-to-noise ratio increases relatively slowly with off-boresight angle out to  $\Delta/\Sigma = 1$ , more rapidly for larger off-boresight angles.

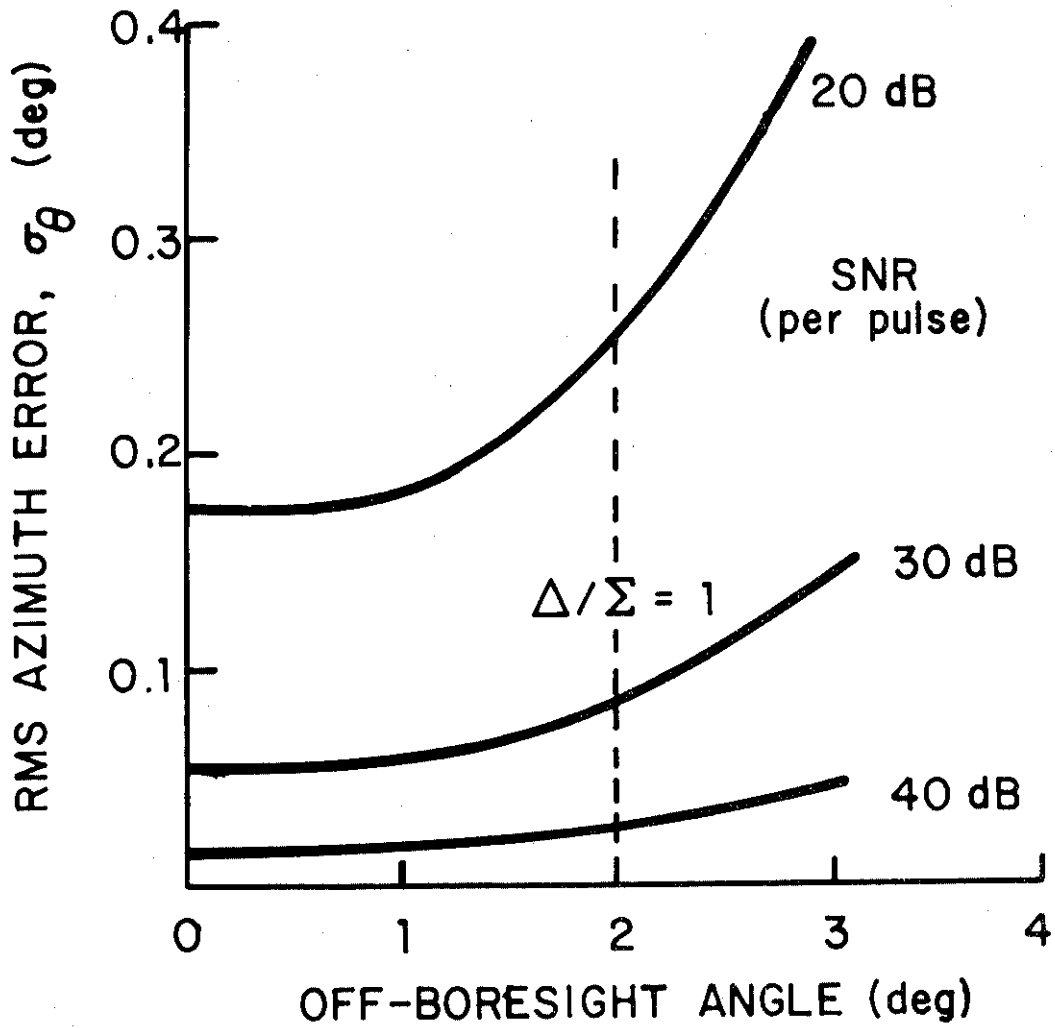

Fig. 5-5. Noise Induced Monopulse Error.

## Processor Inaccuracy

The monopulse receiver-processor must operate over approximately a 60-dB input signal range and must accommodate a  $\pm 3$  MHz variation in the center frequency of replies. While the processor can be precisely calibrated, and this calibration maintained by closed-loop techniques, for any one operating point (signal and frequency), some variation in off-boresight estimate will occur as the parameters of the received signals deviate from this calibration point. As in the case of receiver noise, the errors due to those effects increase with off-boresight angle, gradually out to  $\Delta/\Sigma = 1$ , and more rapidly thereafter. With careful design, practical monopulse processors can be realized which exhibit processor-induced errors substantially less than 1/40 beamwidth ( $0.1^\circ$  for a  $4^\circ$  beamwidth) averaged over the range of expected received signal amplitude and frequency.

## Variation with Elevation Angle

The monopulse receiver-processor measures  $\Delta/\Sigma$  and translates this into an estimate of the off-boresight angle according to a prestored calibration curve for the antenna. The calibration curve is strictly valid only at the elevation angle at which it was measured, typically one or two degrees above the horizon. For targets at relatively high elevation angles ( $15^\circ$  and above), a change in the slope of  $\Delta/\Sigma$  versus off-boresight angle can cause significant errors in the off-boresight angle measurement for targets near the beam edge. However, since such high elevation angles can occur only for relatively short-range targets, the resulting cross-range error is small. Thus, it is not necessary to compensate measurements on such targets for the measurement error resulting from their high elevation angle.

## Multipath and Interference

Interfering signals overlaying the pulses in the desired reply can cause significant error in the monopulse estimate even if their amplitude is substantially less than that of the reply. Such interference may arise from replies, generated by other transponders, which are received in the mainlobe or sidelobes of the interrogator antenna, or from the desired signal arriving by one or more alternate paths.

The most important multipath effect is reflections from the terrain between the interrogator and transponder. If this terrain is essentially flat, it will not effect the apparent angle-of-arrival of the signal but can affect its amplitude. A reduction in received amplitude due to an apparent null can lead to an increased error in the monopulse estimate due to other causes, for example, receiver noise.

If the terrain causing the reflection is tilted, the composite signal arriving at the interrogator antenna will appear to come from a different direction than the actual target azimuth. In this case, the azimuth estimate will depend on the relative amplitude and phase of the multipath signal, as shown in Fig. 5-6 for the case of a target on-boresight and the reflector (interference) a half beamwidth off-boresight. For a given amplitude of inter-

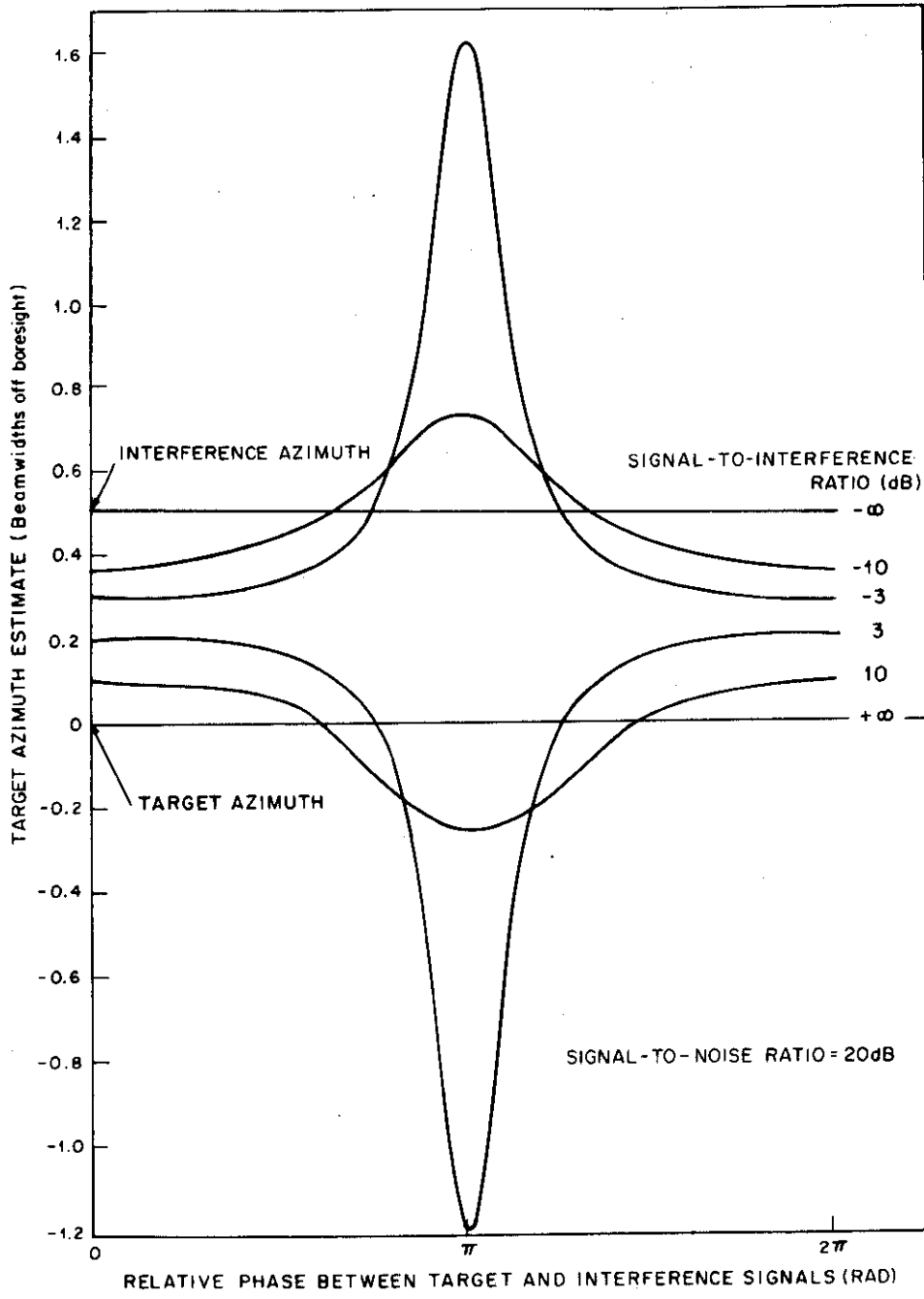

Fig. 5-6. Monopulse Estimate With Interference.

ference, the error is largest when the reflected (interference) signal is out-of-phase with the direct signal. For this worst case of out-of-phase interference, the error as a function of the relative azimuth of the interference is shown in Fig. 5-7 for an interference/target amplitude ratio of 0.5. Errors from multipath are minimized by narrowing the azimuth beamwidth of the interrogator antenna and sharpening the lower edge of the antenna beam, thereby minimizing the amplitude of the signals received from the terrain reflections.

The magnitude and frequency of occurrence of reflection-induced errors are highly site-dependent. Particularly troublesome sites may require resiting of the antenna and/or special antenna configurations to provide adequate performance. (Note that the magnitude of reflection-induced errors using monopulse direction finding is comparable of those of the sliding-window detector/estimator used in current ATRBS interrogators, Ref. 13).

Overlapping signals from other transponders (fruit) produce single-pulse azimuth errors similar to those caused by multipath. Large interfering signals will cause correspondingly large errors in the azimuth estimate. However, unlike multipath interference, fruit interference will be incoherent from pulse-to-pulse, and in general will not affect all pulses of a reply. The main protection against such interference is to sense its presence (the confidence flag) and eliminate that particular measurement from the computation of the azimuth estimate for the reply. The relatively small errors caused by weak interference can be treated as additional receiver noise, and averaged out over a sequence of received pulses.

#### CAPACITY

The capacity of a DABS sensor is most generally defined as the number of aircraft to which a sensor can provide discrete-address surveillance and data-link service. With this broad definition, capacity depends not only on the sensor operating characteristics, but also on the number of interrogations needed for each aircraft and the azimuth distribution, or bunching, of aircraft round the sensor.

A simpler definition of capacity, and one providing a more easily interpreted point of reference, is the number of transactions (interrogation/reply pairs) a sensor can make per degree of azimuth. Using this definition, analysis and simulation of the DABS interrogation scheduling algorithm have led to the following expression for capacity in terms of the sensor operating parameters:

$$n = 18.5 \left[ T - 360 \frac{N_a}{\theta} (2R/c + t_a) \right]$$

MAXIMUM MONOPULSE ERROR (beamwidths)

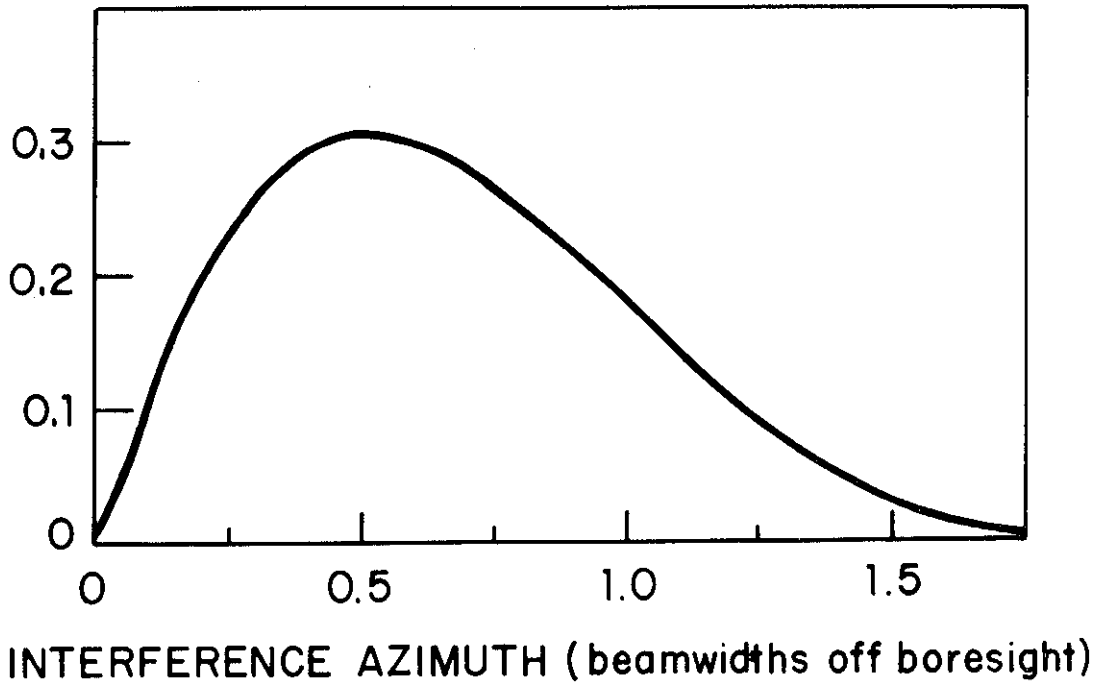

Fig. 5-7. Maximum Monopulse Error With Target On Boresight.

where:

n = number of transactions per degree  
R = operating range  
T = interrogator antenna scan period  
 $\theta$  = interrogator antenna beamwidth  
 $N_a$  = number of ATCRBS interrogations per beamwidth  
 $t_a$  = ATCRBS listening period  
c = speed of light

Figure 5-8 presents plots of capacity vs. interrogator antenna beamwidth for various values of operating range. Typical values are used for scan time (4 seconds) and ATCRBS interrogations per beamwidth (four). Except on the longest (200 nmi) range, the ATCRBS listening interval was set at 2 ms to allow time for ATCRBS replies from distant targets (outside the operating range) to ring out before the beginning of the DABS periods.

The very large capacity of the DABS sensor is evident from these curves. For anticipated interrogator antenna beamwidths ( $2.4^\circ - 4^\circ$ ) and operating range, the channel can accommodate more than 40 calls per degree, a number fully sufficient to accommodate expected sensor loading, including effects of azimuth bunching and multiple interrogations to each aircraft.

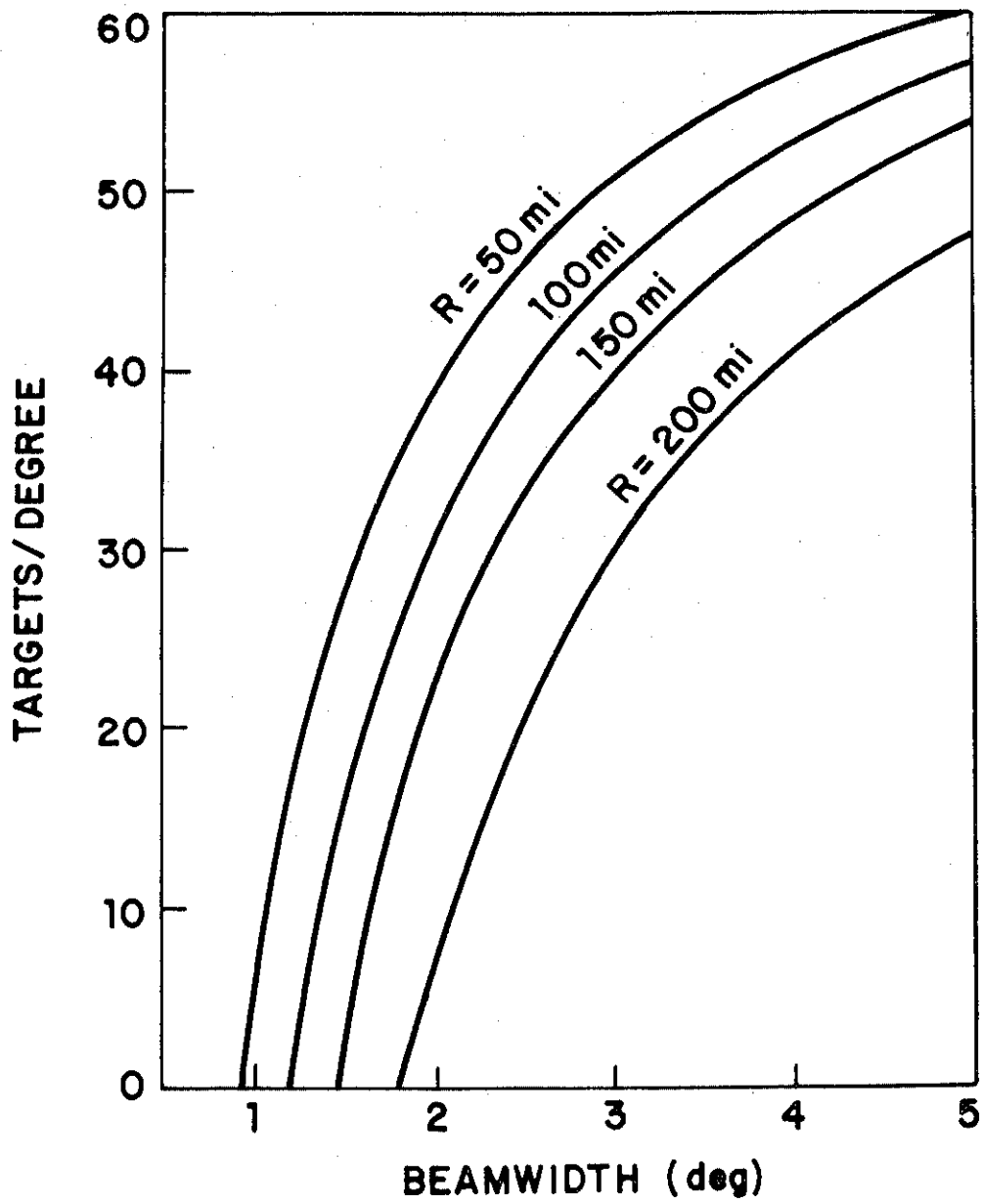

Fig. 5-8. Capacity Plots.



## REFERENCES

1. "Report of Department of Transportation Air Traffic Control Advisory Committee," (December 1969).
2. T.S. Amlie, "A Synchronized Discrete-Address Beacon System," IEEE Trans. Commun COM-21, 421-426 (1973).
3. W.I. Wells, "Verification of DABS Sensor Surveillance Performance Project (ATCRBS Mode) at Typical ASR Sites Throughout CONUS," Project Report ATC-79, Lincoln Laboratory, M.I.T. (20 December 1977), FAA-RD-77-113.
4. "U.S. National Standard for the Discrete Address Beacon System," 1 February 1980, FAA-RD-80-( ).
5. Selection Order: U.S. National Standard for the IFF Mark X (SIF) Air Traffic Control Radar Beacon System (ATCRBS) Characteristics; DOT/FAA Order 1010.51 (10 October 1968).
6. "DABS/ATC Facility Surveillance and Communication Message Formats," FAA-RD-80-14.
7. "Automatic Traffic Advisory and Resolution Services," FAA-RD-80-3.
8. Development of a Discrete Address Beacon System Quarterly Technical Summary, Lincoln Laboratory, M.I.T. (1 July 1974), pp 36-37, FAA-RD-74-136.
9. Ibid, pp. 55-58.
10. Development of a Discrete Address Beacon System, Quarterly Technical Summary, Lincoln Laboratory, M.I.T. (1 January 1974), pp 14-17, FAA-RD-74-8.
11. Development of a Discrete Address Beacon System, Quarterly Technical Summary, Lincoln Laboratory, M.I.T. (1 April 1974), pp. 19-21, FAA-RD-74-85.
12. Ibid, pp. 5-9.
13. Ibid, pp. 49-50.
14. G.J. Schliekert, "An Analysis of Aircraft L-Band Beacon Antenna Patterns," Project Report ATC-37, Lincoln Laboratory, M.I.T. (15 Sept. 1975), FAA-RD-74-144.

15. D.W. Mayweather, "Model Aircraft L-Band Beacon Antenna Pattern Gain Maps," Project Report ATC-44, Lincoln Laboratory, M.I.T. (16 May 1975), FAA-RD-75-75.
16. K.J. Keeping, J-C Sureau, "Scale Model Pattern Measurements of Aircraft L-Band Beacon Antennas," Project Report ATC-47, Lincoln Laboratory, M.I.T. (4 April 1975), FAA-RD-75-23.
17. W.H. Harman, "Effects of RF Power Deviations on BCAS Link Reliability," Project Report ATC-76, Lincoln Laboratory, M.I.T. (7 June 1977), FAA-RD-77-78.