

FAA-RD-80-77

**Project Report
ATC-95**

Moving Target Detector (Mod II) Summary Report

**D. Karp
J. R. Anderson**

3 November 1981

Lincoln Laboratory
MASSACHUSETTS INSTITUTE OF TECHNOLOGY
LExINGTON, MASSACHUSETTS

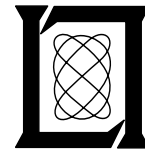

Prepared for the Federal Aviation Administration,
Washington, D.C. 20591

This document is available to the public through
the National Technical Information Service,
Springfield, VA 22161

This document is disseminated under the sponsorship of the Department of Transportation in the interest of information exchange. The United States Government assumes no liability for its contents or use thereof.

1. Report No. FAA-RD-80-77		2. Government Accession No.		3. Recipient's Catalog No.	
4. Title and Subtitle Moving Target Detector (Mod II) Summary Report				5. Report Date 3 November 1981	
				6. Performing Organization Code	
7. Author(s) David Karp and John R. Anderson				8. Performing Organization Report No. ATC-95	
9. Performing Organization Name and Address Lincoln Laboratory, M.I.T. P.O. Box 73 Lexington, MA 02173				10. Work Unit No.	
				11. Contract or Grant No. DOT-FATQ-WAI-679	
12. Sponsoring Agency Name and Address Department of Transportation Federal Aviation Administration Systems Research and Development Service Washington, D.C. 20591				13. Type of Report and Period Covered Summary Report	
				14. Sponsoring Agency Code	
15. Supplementary Notes The work reported in this document was performed at Lincoln Laboratory, a center for research operated by Massachusetts Institute of Technology, under Air Force Contract F19628-80-C-0002.					
16. Abstract Under FAA sponsorship, MIT/Lincoln Laboratory has developed a second generation, field operable Moving Target Detection System (MTD-II) which has been tested at operational FAA terminal and enroute radar sites, and serves as the basis for the ASR-9 MTD technical performance specifications. This summary report covers the period October, 1976 through September, 1979 in which design, development, field testing and system performance evaluation were carried out. Report No. FAA-RD-76-190, ATC-69, "Description and Performance Evaluation of the Moving Target Detector" dated 8 March 1977, serves as the technical foundation of this work. MTD-processing design modifications were effected to handle conditions of excessive ground clutter and moving ground traffic. The rationale for the modified algorithms is provided, and measured performance characteristics at several FAA field sites are discussed.					
17. Key Words Air Traffic Control Radar Signal Processor Moving Target Detection Airport Surveillance Radar Moving Target Indicator Doppler Processor (FIR Filtering) Adaptive Thresholding Parallel Processor			18. Distribution Statement Document is available to the public through the National Technical Information Service, Springfield, Virginia 22151		
19. Security Classif. (of this report) Unclassified		20. Security Classif. (of this page) Unclassified		21. No. of Pages 162	22. Price

DEDICATION

This report is dedicated to David Karp, who will long be remembered with esteem and affection for his leadership and technical contributions in carrying the MTD concept through the field demonstrations.

David Karp was the victim of an auto accident on August 15, 1981.

METRIC CONVERSION FACTORS

Approximate Conversions to Metric Measures

Symbol	When You Know	Multiply by	To Find	Symbol
LENGTH				
in	inches	2.5	centimeters	cm
ft	feet	30	centimeters	cm
yd	yards	0.9	meters	m
mi	miles	1.6	kilometers	km
AREA				
in ²	square inches	6.5	square centimeters	cm ²
ft ²	square feet	0.09	square meters	m ²
yd ²	square yards	0.8	square meters	m ²
mi ²	square miles	2.5	square kilometers	km ²
	acres	0.4	hectares	ha
MASS (weight)				
oz	ounces	28	grams	g
lb	pounds	0.45	kilograms	kg
	short tons (2000 lb)	0.9	tonnes	t
VOLUME				
tsp	teaspoons	5	milliliters	ml
Tbsp	tablespoons	15	milliliters	ml
fl oz	fluid ounces	30	milliliters	ml
c	cups	0.24	liters	l
pt	pints	0.47	liters	l
qt	quarts	0.95	liters	l
gal	gallons	3.8	liters	l
ft ³	cubic feet	0.03	cubic meters	m ³
yd ³	cubic yards	0.76	cubic meters	m ³
TEMPERATURE (exact)				
°F	Fahrenheit temperature	5/9 (after subtracting 32)	Celsius temperature	°C

*1 in = 2.54 (exactly). For other exact conversions and more detailed tables, see NBS Misc. Publ. 286, Units of Weights and Measures, Price \$2.25, SD Catalog No. C13.10-286.

Approximate Conversions from Metric Measures

Symbol	When You Know	Multiply by	To Find	Symbol
LENGTH				
mm	millimeters	0.04	inches	in
cm	centimeters	0.4	inches	in
m	meters	3.3	feet	ft
m	meters	1.1	yards	yd
km	kilometers	0.6	miles	mi
AREA				
cm ²	square centimeters	0.16	square inches	in ²
m ²	square meters	1.2	square yards	yd ²
km ²	square kilometers	0.4	square miles	mi ²
ha	hectares (10,000 m ²)	2.5	acres	
MASS (weight)				
g	grams	0.035	ounces	oz
kg	kilograms	2.2	pounds	lb
t	tonnes (1000 kg)	1.1	short tons	
VOLUME				
ml	milliliters	0.03	fluid ounces	fl oz
l	liters	2.1	pints	pt
l	liters	1.06	quarts	qt
l	liters	0.26	gallons	gal
m ³	cubic meters	35	cubic feet	ft ³
m ³	cubic meters	1.3	cubic yards	yd ³
TEMPERATURE (exact)				
°C	Celsius temperature	9/5 (then add 32)	Fahrenheit temperature	°F

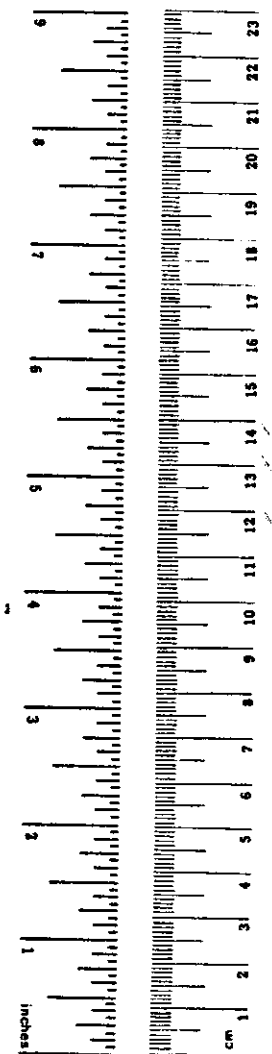
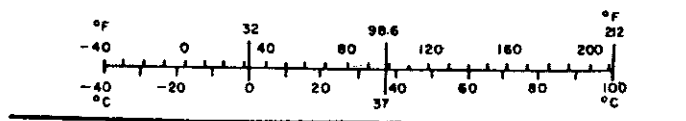

CONTENTS

	<u>Page</u>
I. INTRODUCTION	I-1
A. Features of the MTD-II	I-1
B. Ground Clutter	I-2
II. SYSTEM ARCHITECTURE	II-1
A. Introduction	II-1
B. Signal Processing	II-3
1. PMP-2 Architecture	II-3
2. Doppler Filter Design	II-3
3. CFAR Thresholding	II-5
4. Zero Velocity Filter Thresholding	II-9
5. Weather Data Extraction	II-9
C. Correlation and Interpolation	II-9
1. Fine-Grain Fixed Thresholding	II-10
2. Target Correlation and Interpolation	II-11
3. Adaptive Target Thresholding	II-11
4. Weather Contour Processing	II-13
D. Surveillance Processing	II-13
1. Scan-to-Scan Correlation	II-13
2. Output Processing	II-15
III. PERFORMANCE EVALUATION	III-1
A. Introduction	III-1
B. Burlington, VT (BTV)	III-1
1. Installation and Site Description	III-1
2. General Performance	III-3

CONTENTS (Continued)

	<u>Page</u>
C. FAATC - Atlantic City, NJ	III-10
1. Installation and Site Description	III-10
2. Performance	III-14
3. Additional Results	III-14
D. Bedford, VA	III-18
1. Installation and Site Description	III-18
2. MTD Performance	III-22
3. Overview of MTD-II	III-25
IV. MISCELLANEOUS SYSTEM ISSUES	IV-1
A. FIR-Filters and Ground Clutter	IV-1
1. Cumulative Distribution Function of C_1/N_0	IV-2
2. Radar System Instability	IV-2
3. Limiting	IV-4
4. Fixed-Threshold Map	IV-8
5. Clutter Residue Mapping Processor	IV-8
B. High-Angle Coverage with STC	IV-12
C. System Software	IV-17
D. Diagnostics	
REFERENCES	IV-23
APPENDIX A: Technical Data Package for Airport Surveillance Radar with Moving Target Detection (ASR-MTD)	A-1
APPENDIX B: PMP/PM Correlation (Clustering) and Interpolation	B-1
APPENDIX C: List of ASR-MTD Acronyms and Abbreviations	C-1

ILLUSTRATIONS

<u>Fig.</u>		<u>Page</u>
II-1	MTD Functional Block Diagram	II-2
II-2	PMP-2 Processing, Block Diagram	II-4
II-3a	MTD Filter Bank Gain Characteristics	II-6
II-3b	MTD Filter Bank Gain Characteristics	II-7
II-3c	MTD Zero-Velocity Filter Characteristics	II-8
II-4	Example of Bird/Aircraft Cross-section Distribution at Burlington, VT	II-12
II-5	10 Scans of Data from NAFEC, Atlantic City, NJ.	II-14
II-6a	Weather Contours (30 dBz) Due to Ground Clutter at Burlington, VT	II-16
II-6b	Weather Contours (30 dBz) Due to Rain and Ground Clutter at Burlington, VT	II-17
II-6c	Weather Contours (30 dBz) Due to Rain and Ground Clutter Rejected at Burlington, VT	II-18
II-6d	Weather Contours (30 dBz) Using Only the Higher Pass Filter at Burlington, VT	II-19
II-7	Frequency Response of High-Pass Filter	II-20
III-1	ASR-7 MTD/MTI at Burlington, VT Functional Block Diagram	III-2
III-2	Burlington, VT (BTV) ASR-7/MTD Site	III-4
III-3	Ground Clutter (40dB S/N) at Burlington, VT	III-5
III-4	Ground Clutter Characteristic at Burlington, VT	III-6
III-5	Real-Time System - Fixed Threshold Map for Burlington, VT (1=Low Level Threshold, 2=High Level Threshold)	III-7
III-6	MTD Targets and Tracker Output (100 scans, 60 nmi radius)	III-8
III-7	MTD Performance in Rain	III-9
III-8	Track of Test Aircraft at Burlington, VT	III-11
III-9	MTD/DABS at FAATC, Functional Block Diagram	III-12
III-10	Threshold Map, MTD/DABS at FAATC (1=Low Level Threshold, 2=High Level Threshold)	III-13
III-11a	MTD Target Reports (50 scans) at FAATC	III-15
III-11b	MTD Tracker Output (50 scans) at FAATC	III-16
III-12	Total Azimuth Error Distribution	III-17
III-13	Azimuth Error by Target Quality	III-19
III-14	Fine-Grain Threshold Cell No. 2 (Filter No. 1 & 2)	III-20
III-15	Dual System at Bedford, VA, Block Diagram Showing Modems	III-21
III-16	Clutter Map - BVA	III-23
III-17	Fixed Threshold Map for Bedford, MA	III-24
III-18	MTD Target Report, Gulfstream Flight	III-26
III-19	Radar Target Reports; MTD vs CD	III-27
III-20	Target Reports Using Target Extractor at Bedford, VA MTD vs CD vs Beacon	III-28
III-21a	Beacon Reports on Gulfstream Aircraft (4-Altitude Flights)	III-29
III-21b	Radar Reports on Gulfstream Aircraft (4-Altitude Flights)	III-30

ILLUSTRATIONS (Continued)

<u>Fig.</u>		<u>Page</u>
IV-1	BTV Clutter, Cumulative Probability Distribution	IV-3
IV-2	IF-Video Processor	IV-5
IV-3	Limiting IF Transfer Function	IV-6
IV-4	Ground Clutter Scanning Modulation Residue (Linear)	IV-7
IV-5	Ground Clutter Scanning Modulation Residue (20 dB limiting)	IV-9
IV-6	Example of 20 dB Hard Limiting	IV-10
IV-7	Normalized Frequency - Fractional PRF	IV-11
IV-8a	MTD Target Reports - Residue Map	IV-13
IV-8b	MTD Target Reports - Linear CFAR	IV-13
IV-9a	MTD Target Reports - Residue Map	IV-14
IV-9b	MTD Target Reports - Linear CFAR	IV-14
IV-10	30 dB C_i/N_o Contours for Area which Includes Regions of Figs. IV-8 and IV-9	IV-15
IV-11	Single 8-Pulse CPI Sample (8-Scans, High P_{FA})	IV-16
IV-12	ASR-7 Antenna Tilt to Simulate ASR-8 Passive Horn	IV-18
IV-13	PMP/PM C and I Real-Time System, Functional Block Diagram	IV-19
IV-14	PMP/PM C and I Targets	IV-20
IV-15	PMP/PM C and I Targets	IV-22

MTD-II SUMMARY REPORT

I. INTRODUCTION

Modern radar signal processing techniques embodied in a digital signal processor called the Moving Target Detector (MTD) developed by M.I.T./Lincoln Laboratory were evaluated at the FAA Technical Center, "FAATC", Atlantic City, New Jersey several years ago [Refs. 1 and 2]. These evaluation tests demonstrated that the application of modern signal processing techniques can provide high quality aircraft surveillance data continuously in the presence of ground and weather clutter.

The purpose of the MTD-II program reported herein was to refine the original Moving Target Detector system and to demonstrate and evaluate the improved system at actual operational radar sites. These evaluation and demonstration tests took place near:

Burlington, VT, at an ASR-7 terminal site (designated herein as BTV) characterized by unusually "difficult" ground clutter.

Bedford, VA, at an FPS-20 enroute site (designated herein as BVA) characterized by severe ground clutter and within-view vehicular traffic.

Atlantic City, NJ, at an ASR-7 terminal site under the jurisdiction of the FAATC. At this site radar data was collected simultaneously with FAATC Discrete Address Beacon System (DABS) beacon data in order to permit large-sample studies of the MTD-II detection and position accuracy statistics.

This report explains why certain processing algorithms were used, and how the measured system performance was achieved at the several FAA operational sites at which it was tested.

A. Features of the MTD-II

The improved radar surveillance processor, MTD-II, extends the capability of the previously evaluated processor in these functional areas:

PMP-II processor: The signal processing functions were implemented in a parallel microprogrammed processor (the PMP-II) designed specifically for this radar application. This parallel processor permits easy modification of signal processing algorithms for the purpose of site adaptation and installation of experimental changes.

FIR filter bank: The signal processing architecture has been changed to that of a general finite impulse response (FIR) filter bank. The original architecture was that of a three-pulse canceller preceding a weighted discrete Fourier transform. Greater control of the doppler frequency response and filter sidelobes is now possible for improved performance in ground and weather clutter.

New thresholding mechanisms: Post detection processing has been redesigned to provide a set of fixed and adaptive thresholding mechanisms which, a) enforce low false alarm rates in areas where moving objects such as birds and ground vehicles are visible, and b) remove false alarms from areas of extreme ground clutter amplitude. The adaptive thresholding technique developed does not depend on absolute target detection density and does not exhibit a tendency to reduce sensitivity in areas of heavy aircraft traffic.

Improved surveillance processing: The MTD-II employs a new surveillance processor which uses scan-to-scan correlation to remove non-spatially and non-temporally correlated false alarms. Algorithms have been developed to provide indicators of target statistics, principally measurement accuracy, which are then used to improve the performance of the tracker used in the scan-to-scan correlation.

Display of weather contours: In addition to aircraft surveillance information the MTD-II processes and displays two radar reflectivity contours for weather detection. These levels are normalized to conform (to the maximum extent possible given the surveillance antenna patterns) with two of the National Weather Services precipitation levels.

B. Ground Clutter

Extreme amplitude ground clutter encountered at the Burlington, VT, site led to an in-depth analysis of the performance of FIR filter bank processors in high clutter environments. This analysis suggested new techniques for dealing with radar system instabilities which employ smooth limiting to increase the dynamic range of the A/D converters. Other solutions to the problems inherent in the use of an FIR filter bank processor in clutter exceeding its matched design parameters were also suggested.

II. SYSTEM ARCHITECTURE

A. Introduction

Details of the MTD-II design are contained in "Technical Data Package" for Airport Surveillance Radar with Moving Target Detector", Appendix A, to this report.

The MTD is designed as a three stage processor which automatically and adaptively reduces the data rate from one million samples/second to displayable target reports (20 Kbits/second in the terminal, and 8 Kbits/second in the en-route system). Reports at these rates can be transmitted using standard phone-line modems and voice grade channels.

The first stage of processing includes saturation/interference testing, filtering in the velocity domain, constant false alarm rate (CFAR) thresholding, clutter mapping for zero-velocity target processing, and adaptive desensitization for large amplitude clutter. The output of this stage consists of primitive target declarations which may vary from a few hundred per scan to ten thousand per scan, depending on A/C traffic and anomalous "angel activity". An A/C target may produce 1 to 50 primitive target reports per scan, depending on crosssection and range.

The second stage of processing, "correlation and interpolation" (C&I), correlates primitive reports which are associated with the same target by range/azimuth adjacency, interpolates to develop the centroid of measurement variables (range, azimuth, velocity, and amplitude), performs adaptive and fixed second-level thresholding, and flags the target reports with quality/confidence before transmitting them to the third-level processing, tracking, or filtering. The C&I stage of processing attempts to produce a single target report for each moving A/C target within coverage, on each scan of the antenna, while adaptively limiting the false alarms (due to noise, ground clutter, and angel activity) to fewer than 60 per scan.

The final stage of processing uses target scan-to-scan history to "track" moving A/C targets while filtering out those target reports which are not associated with moving A/C. Approximately 0.98 of the A/C reports entering this processor are transmitted for display, while fewer than one false alarm per scan are transmitted for display under most conditions.

A block diagram of the MTD system is shown in Fig. II-1. The received IF signal from the radar is smoothly limited to a dynamic range of 51 dB. The IF and COHO signals are then processed with a linear receiver to provide in-phase and quadrature video signals which are sampled with 10-bit A/D converters. This data is stored for the remainder of an 8-pulse coherent processing interval (CPI) in the input memories of a PMP-2 [Ref. 1]. The signal processor performs the doppler filtering and thresholding functions and outputs range, azimuth, doppler and amplitude information for each cell in which threshold

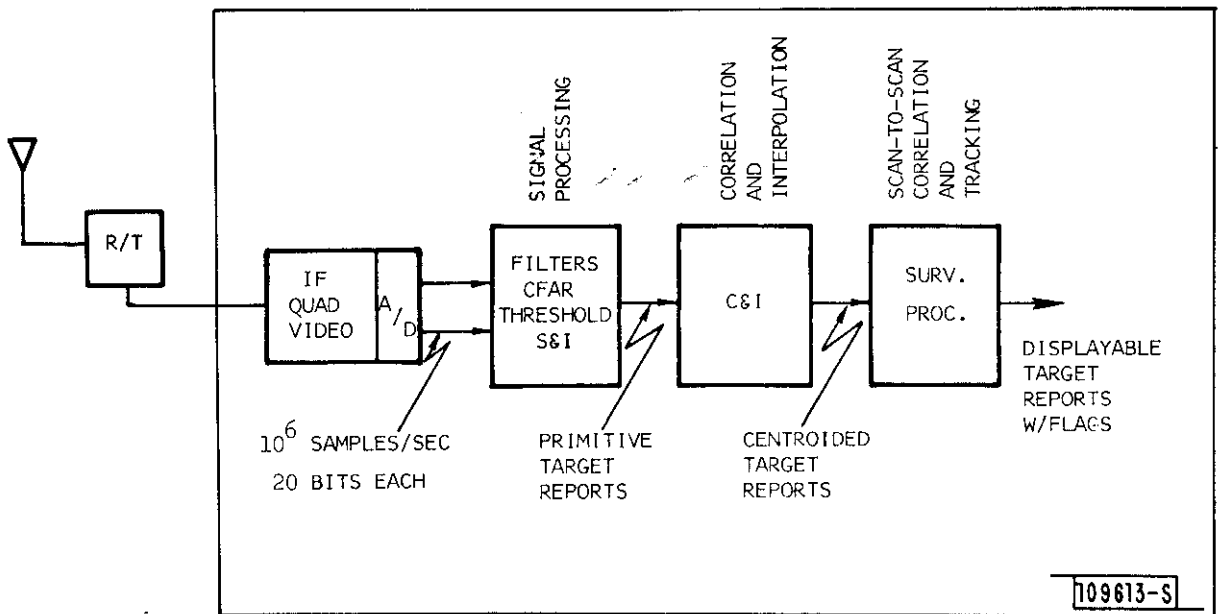

Fig. II-1. MTD functional block diagram.

crossings are detected. These threshold crossings are then sent to a correlation and interpolation (C&I) processor, where they are first correlated into target reports and then centroided in range and azimuth. These targets are subjected to fixed and adaptive false alarm rejection thresholds to produce target reports. The target reports are finally edited using a scan-to-scan correlator to reduce the output false alarm rate to a typical value of 1 false-alarm per scan.

B. Signal Processing

Signal processing in the context of MTD-II is defined as those tasks occurring between the digitization of in-phase and quadrature channel radar video and the output of range-azimuth-doppler cell threshold crossings (primitive targets). For signal processing purposes the MTD-II surveillance space is divided into 512 8-pulse Coherent Processing Intervals (CPI) per scan. To remove single PRF blind speeds and to improve detection of ambiguous velocity aircraft in rain, the radar PRF is alternated by about 20% every CPI. Each CPI is sampled at range gate intervals of 1/16 nmi for terminal radars (60 nmi instrumented range) and 1/8 nmi for enroute radars (180 nmi instrumented range). The signal processing functions consist of saturation and interference testing, doppler filtering, magnitude calculation, and constant false-alarm rate (CFAR) thresholding.

1. PMP-2 Architecture

The Parallel Microprogrammed Processor, Version II (PMP-2) shown in Fig. II-2 is a single instruction stream, multiple data stream, parallel processor consisting of a microprogrammed controller and a number of processing elements (PE's). Each PE has a dedicated double buffered input memory connected to the A/D converters and is assigned a particular range segment to process. The MTD-II implementation consists of a 7 PE unit of which any 6 PE's are active at a given time, the seventh PE being reserved as a spare to provide a measure of fault tolerance. Each of the six active PE's process an 11 nautical mile range segment including a 1/2 nmi overlap at each boundary. This overlap is necessary to allow for the calculation of the range averaged CFAR thresholds. A more complete description of the PMP-2 architecture is given in Ref. 3.

2. Doppler Filter Design

MTD-II doppler filtering is accomplished using a bank of eight-pulse linear FIR filters. One of these filters includes zero-doppler velocity and is thresholded with a time-averaged CFAR threshold. The other seven are thresholded using a sliding window, range-averaged CFAR.

The zero velocity filter was designed as a linear phase equiripple low pass filter [Ref. 4] with pass-band equal to that part of the doppler band not covered by the seven remaining filters. Stop-band side lobes have been constrained to provide good detection performance in rain clutter. The filter coefficients have been quantized to 4 bits plus sign.

109614-S

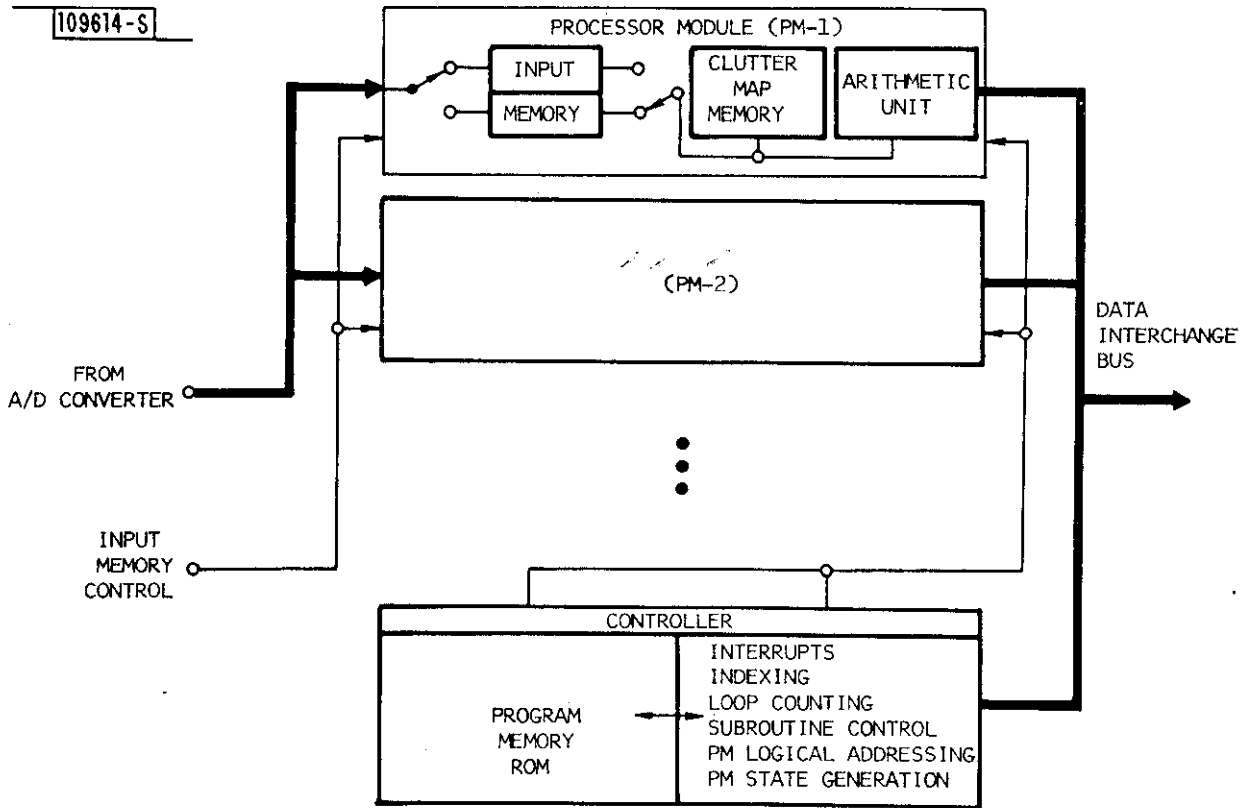

Fig. II-2. PMP-2 processing, block diagram.

The non-zero filters have been designed, using the technique of DeLong and Hofsetter [Ref. 5], to approximate an optimum processor envelope for interference composed of 40 dB (single pulse S/N) ground clutter returns with the antenna modulation spectrum, plus a component which is white in doppler except in the vicinity of the filter center-frequency so as to represent rain clutter. The filters have been further constrained by forcing the system function $H(z)$ to have a zero at $z=1$ when the filters are quantized to 5 or 6 bits plus sign. This is to reduce the effect of coefficient quantization on the ground clutter rejection capability. To increase computation efficiency, filters 5, 6, and 7 have been taken to be the complex conjugates of filters 3, 2, and 1. Plots of the frequency response realized for the individual filters are given in Figs. II-3a, -3b and -3c.

The choice of 40 dB S/N ground clutter for the filter bank design is based on the need to achieve good performance in ground clutter areas without overly degrading the low doppler frequency performance in areas of light clutter and masked terrain, as well as considerations of radar stability. It should be noted that this required the use of special techniques for reducing false alarms in areas where the clutter exceeds 40 dB S/N. This problem is discussed in more detail in Section IV.

3. CFAR Thresholding

The seven non-zero velocity doppler filter magnitudes are thresholded, to remove weather false-alarms, with a range sliding window average of six range cells preceding, and seven cells following, the cell of interest and two adjacent cells. This average is multiplied by a constant (4.875, to achieve a 10^{-5} false-alarm rate) to produce a threshold value. In cells with high DC return a fraction (dependent on filter) of the zero velocity magnitude is also added to the threshold to control the data rate due to ground clutter false alarms. Due to processor limitations, the threshold average is calculated as a linear average of magnitude (voltage) rather than an average of powers resulting in a larger CFAR loss than normally associated with a 13 point sample. The total thresholding loss is approximately 2 dB.

In the terminal systems, the first six range gates were thresholded with a fixed threshold value to allow short range surveillance of departing and arriving aircraft. The en route implementation did not declare targets from these cells.

In the long range implementation where sensitivity in noise is a greater design concern, an alternative to the above technique has been implemented on an experimental basis. In order to reduce the CFAR loss for the case of a target in known amplitude noise, a far more frequent occurrence than that of weather, a threshold of the following type is used:

$$\text{Threshold} = \max [\alpha, 4.875 \bar{v} - \beta]$$

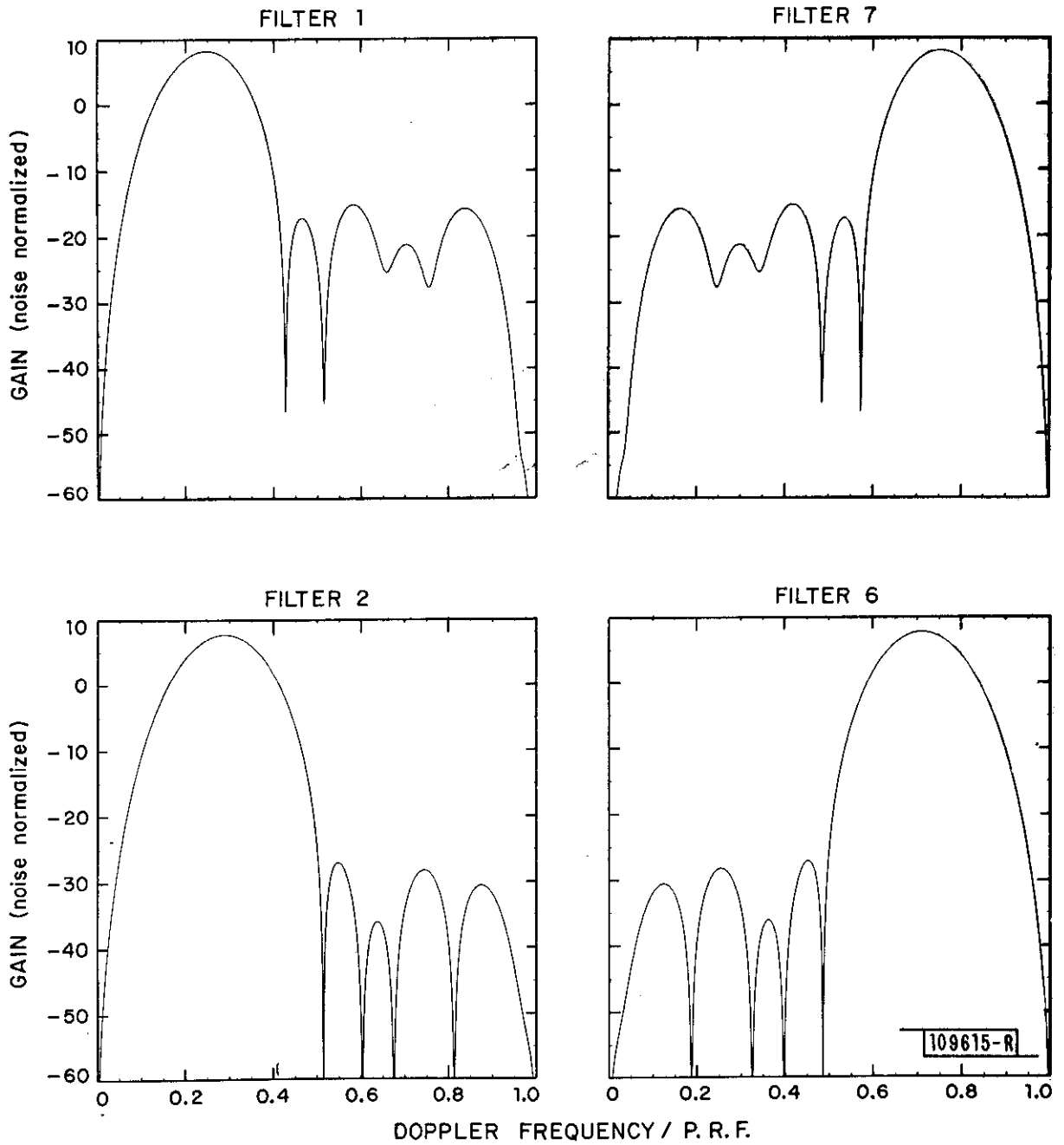
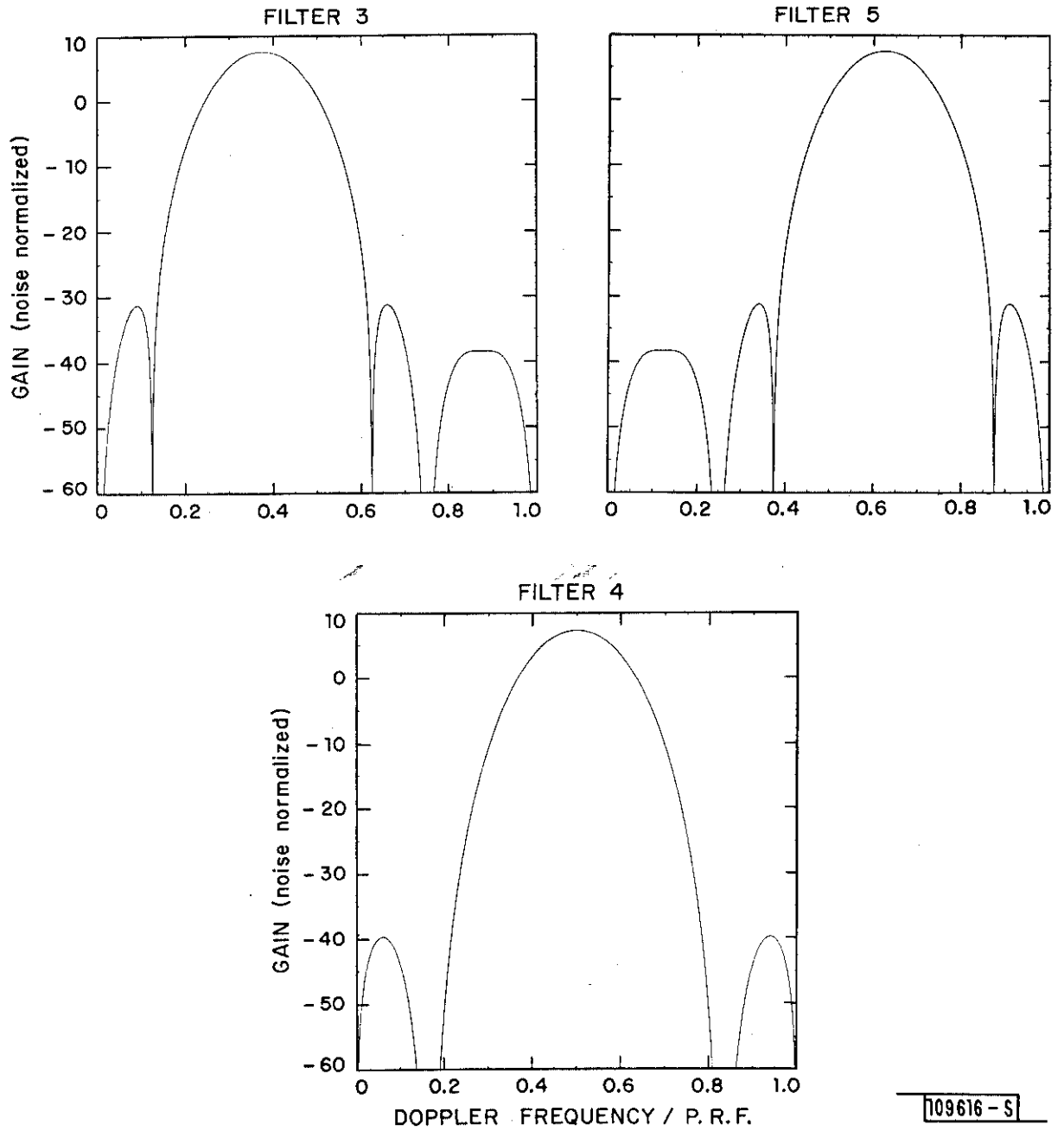

Fig. II-3a. MTD filter bank gain characteristics.



109616-S

Fig. II-3b. MTD filter bank gain characteristics.

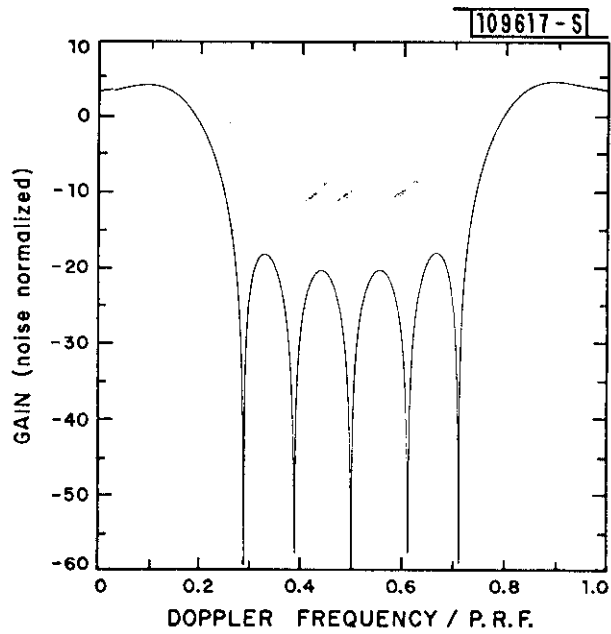

Fig. II-3c. MTD zero-velocity filter characteristics.

where \bar{v} is the range averaged magnitude, and α and β are constants. The effect of a threshold generated in this manner is to almost eliminate the CFAR loss in noise by generating a nearly constant threshold when only noise is encountered. This occurs at the expense of a higher false-alarm rate when weather of slightly greater magnitude than the noise is present. In cases of large weather returns it is essentially identical to the original algorithm. This approach is similar to that proposed by R. Nitzberg [Ref. 6].

4. Zero Velocity Filter Thresholding

The zero-doppler velocity filter is thresholded using a single pole average of the values measured in the same cell over several scans. As a large number of cells ($\approx 500,000$) are involved, an effort has been made to store this information using as few bits as possible. The choice of an 8-bit (3 bit mantissa, 5 bit exponent) floating point format defines an effective limit of about eight measurements as the averaging time constant. This corresponds to a CFAR loss of approximately 3 dB. Although the threshold time constant is limited to 8 measurements by the memory precision, it is possible to extend the effective time constant by not updating the threshold every scan. This has the advantage of being less sensitive to slowly flying tangential targets and of allowing more time for decorrelation of clutter amplitudes. The need to adapt to changes in weather amplitudes constrains this extension, however, and a compromise must be achieved. In the course of the MTD-II testing an update rate of every-other-scan was found to be effective.

5. Weather Data Extraction

An additional function performed by the signal processor is the extraction of weather data from the radar video for contouring and display to the air traffic controller. This is done by first generating two doppler filters, one all-pass and one high-pass from weighted sums of the doppler filter magnitudes. These filter values are averaged over a 1 nmi interval, and every 1/2 nmi are compared to a threshold normalized for beam-filled radar reflectivity ($1/R^2$) and the sensitivity time control (STC). The results of these comparisons for output are further processing by the surveillance processor. On alternate scans the thresholding levels are changed so that two levels of weather contours are measured.

C. Correlation and Interpolation

The primitive targets output from the signal processing functions are first subjected to a fine grain fixed-threshold map for removal of false alarms due to ground traffic and large clutter areas. Primitive targets are then merged to form clusters. A range and azimuth estimate is assigned to each cluster to produce a centroided target report. Each target report is subjected to adaptive thresholds designed to remove reports due to birds or extremely localized fast-moving rain cells.

1. Fine-Grain Fixed Thresholding

To remove false alarms due to ground traffic and high-amplitude ground clutter, a fine-grain map is kept for the purpose of storing a priori knowledge about the location of visible sections of roads and the locations of areas where ground clutter is larger in amplitude than that to which the filter bank is matched exist.

This map is implemented in the MTD-II with a resolution of 1/4 nmi range by 2 CPI's. Each cell allows the selection of either a flat doppler response threshold of one of two levels, or a threshold with a doppler response equal to the clutter residue amplitude of the MTD-II filters. The use of this map in ground clutter is much the same as the use of a Range Azimuth Gain control (RAG) STC, but it has the advantage of allowing different threshold values for different doppler filters and avoiding the difficulty of the interaction between the RAG STC and the range CFAR thresholding on rain. However, in order to avoid target losses due to limiting, the map requires a larger receiver dynamic range than with the use of the RAG STC. This is discussed in more detail in Section IV.

The sensor map is designed to eliminate two false-alarm mechanisms: those due to moving ground traffic and those due to clutter that is mismatched to the filter bank. A set of threshold levels was developed for each of two different classes of doppler shapes. One shape is designed around the peak of the time domain Gaussian impulse residue of the filters, which is different than the frequency response residue of the filters. The other one is flat.

A data sample was taken, during a period of low A/C traffic density at night, to build a map for ground clutter. A "small cell" false alarm rate out of this "filter" which was considered to be the maximum acceptable by the surveillance processor was established, then thresholds were set using the doppler shape threshold such that the false alarm rate was acceptable. A value of 0.1 per scan per track initiation box size was used. Next, a sample was taken during the day with typical ground traffic activity and the same process using flat thresholds performed. The map was then hand-edited to remove areas containing cells that were due to air traffic lanes in use at the time, and repeated on different days when different flight patterns were in use to remove those cells. Hand editing was involved in the generation of the maps, especially the ground traffic map.

The reason that this was done adaptively over a long time period is because it does require human intervention to remove the targets that are known to be due to aircraft. In general, we have found that the maps, once produced, are very stable.

In summary, it is not correct when using a scanning radar, to consider only the frequency response of filter banks. The time domain response is

important, because the statistics of the clutter and therefore the scanning modulation residue are not stationary. They would be stationary if the clutter consisted of a large number of random amplitude distributed scatterers. What was actually observed was that the ground clutter is often dominated by large single speculars.

2. Target Correlation and Interpolation

The primitive targets which survive the fixed thresholding are subjected to an adaptive threshold which is determined by lowering the post-clustering adaptive threshold level (see II-B.3 below) by 10 dB for the purpose of lowering the processing load in a dense bird-clutter environment without significantly degrading azimuth accuracy. Following this first stage of adaptive thresholding, the remaining primitive targets are grouped into clusters on the basis of range and azimuth adjacency. Each cluster is then centroided using a "center of mass" (first moment weighted by amplitude) estimator to produce a centroided range and azimuth. At this point, a report "quality factor" is appended to each centroided target report indicating the following:

	<u>Quality</u>
One CPI report	0
Two CPI reports, different types	1
Two or more CPI reports, same PRF	2
Two or more CPI's each PRF	3

3. Adaptive Target Thresholding

At many sites the occurrence of targets due to birds or "angels" is a common occurrence. Angel reports have been observed to have a roughly log-normal amplitude distribution with a mean cross-section of approximately -25 dBSM (square meter). In contrast, the population of aircraft targets has an apparent mean cross-section (including beam losses) of slightly less than 0 dBSM. Thus there exists with sufficient integration a way to determine if angel false alarms are present in a given target sample. An example of the cross-section population of birds and aircraft targets from Burlington, Vermont is given in Fig. II-4. As the distributions overlap, it is impossible to precisely determine whether a particular report is due to an aircraft or a bird. Instead we attempt to limit the angel false alarm rate to a fixed maximum value with as little loss in aircraft detection as possible. The method used to accomplish this is to count the number of large cross-section targets to infer the number of aircraft and subtract this number from the number of small targets to make an estimate of the angel false alarm rate. If the difference exceeds a predefined value (nominally 60 per scan in the entire coverage area), the threshold for that spatial area is raised. If the rate is significantly less than the acceptable false alarm rate, the threshold is lowered. This technique is used as opposed to a simple density threshold to avoid decreasing sensitivity in dense aircraft environments.

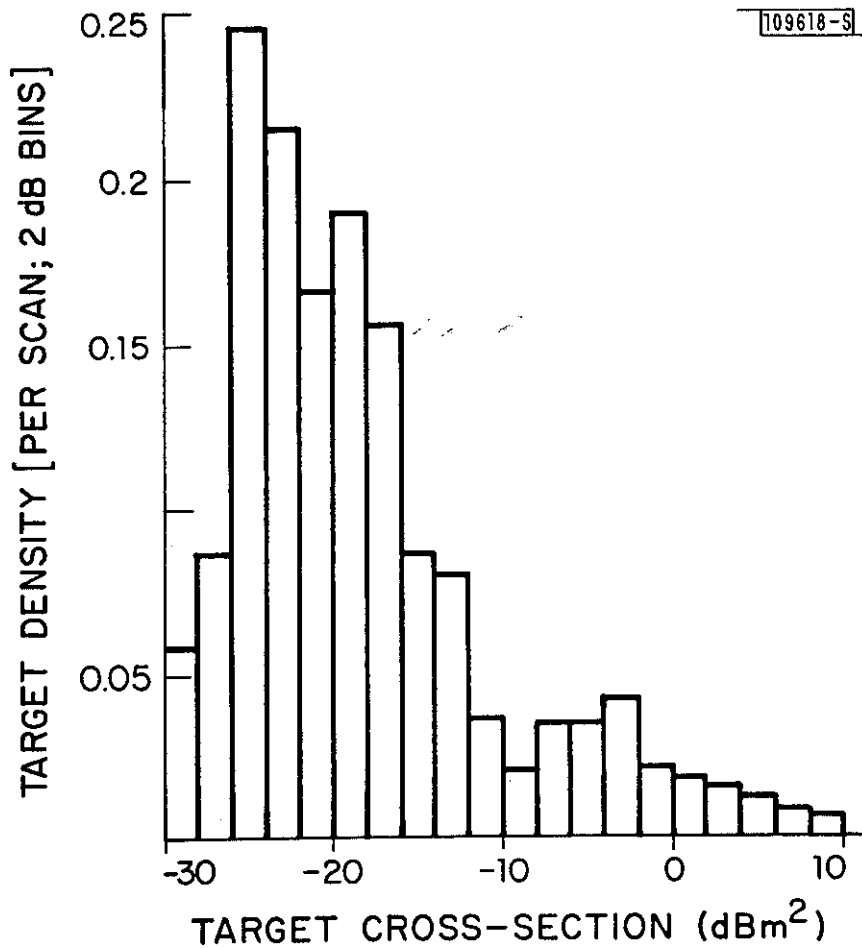

Fig. II-4. Example of bird/aircraft cross-section distribution at Burlington, VT.

Due to the conflict between the needs for fast response and sufficient target statistics, this thresholding is implemented as a series of two sequential filters. The first integrates over a relatively long time (~200 sec) using roughly equal sized small areas (16 sq nmi by 3 doppler bins terminal; 64 sq. nmi by 3 doppler bins en route), the second is much faster acting (~15 sec), integrating over the entire coverage space for ranges less than 20 nmi (40 nmi en route) also using 3 doppler bins*. The purpose of this structure is to achieve fast response at the onset of false alarms for ranges less than 20 nmi. Where birds are frequently detected while providing localized attenuation for longer lived phenomena. An example of the performance of this algorithm in heavy angel conditions is shown in Fig. II-5 using data from FAATC.

4. Weather Contour Processing

The weather contour processing function accepts as its input six scans of weather threshold-crossing data from the signal processor (3 scans each high and low level). A static map is used to denote those areas where enough ground clutter is present so that the doppler high-pass data-stream must be used. This map is compiled for each intensity level. After merging the high-pass and all-pass data streams in this way, the data is smoothed with temporal and spatial filters and output to the user or display system. The standard form of this output is specified in terms of starting and ending ranges for each weather level and azimuth. Examples of this processing for a storm near the Burlington, VT site are given in Fig. II-6.

Figure II-6a shows +30 dBz weather contours, when using the all-pass filter, and is due entirely to ground clutter. Fig. II-6b shows +30 dBz weather contours, with rain to the south of BTV. Fig. II-6c shows the resultant +30 dBz weather contour output after using the static map to select and merge the all-pass and high-pass data streams. The "false" contours due to ground clutter have essentially been eliminated, and the regions in which the rain rate exceeds 30 dBz (2.7 mm/Hz) are displayed. Fig. II-6d shows 30 dBz contours of the same storm when only the high-pass data stream is used. Thus, removing the near zero-velocity components of the storm (as would be the case with MTI processing-only) provides an inaccurate picture of the location of the storm. Fig. II-7 shows the frequency response of the high-pass filter, obtained by constructing a weighted sum of the magnitudes of filters 1-7.

D. Surveillance Processing

1. Scan-to-Scan Correlation

The targets which survive the adaptive thresholding process are then input to the scan-to-scan correlator. The scan-to-scan correlator uses tracking algorithms to edit the reports and remove those false alarms which do not have the scan-to-scan position relationship expected of an aircraft target. A

*This is bird detection region.

-4-20878

II-14

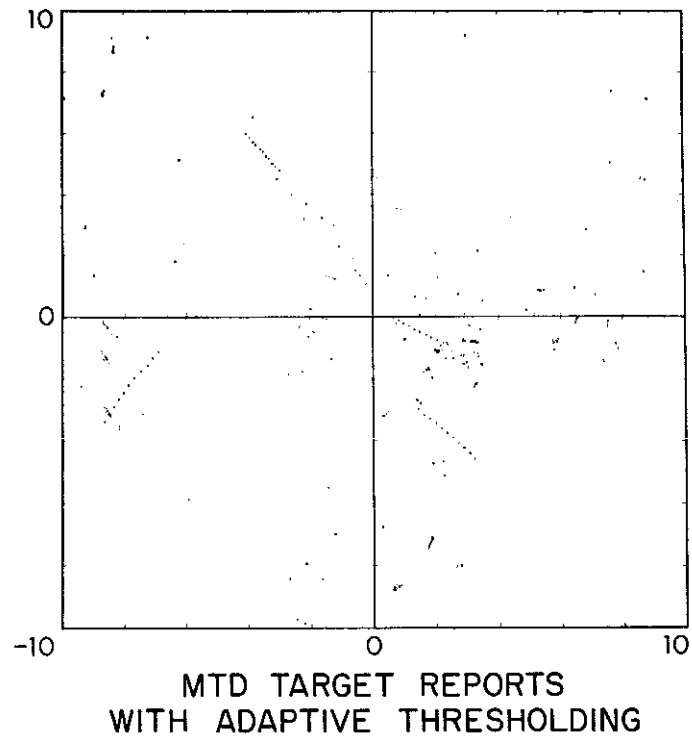
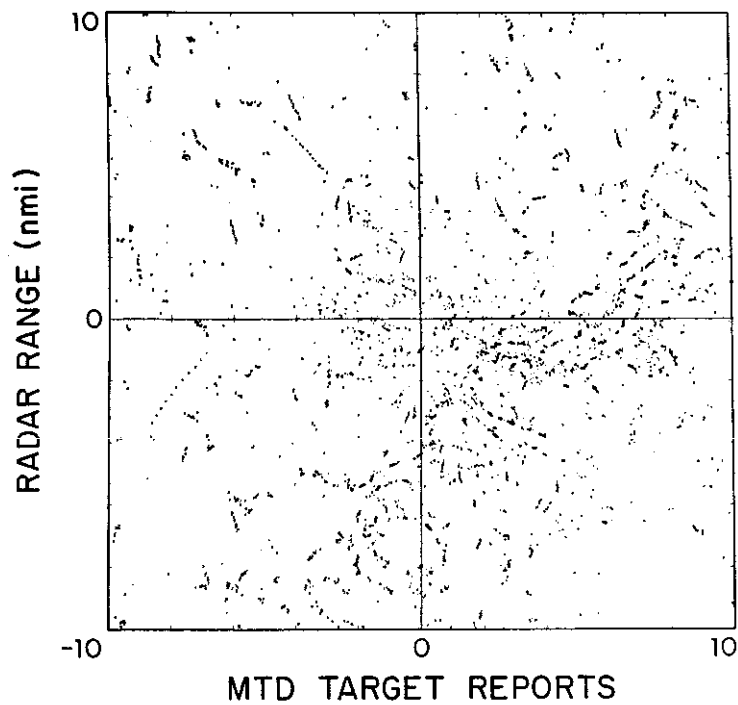

Fig. II-5. 10 scans of data from NAFEC, Atlantic City, NJ.

significant choice in the design of the MTD tracker was the decision not to place a lower limit on the velocity of the tracks. This was done to avoid suppressing the detection of helicopters or small aircraft in headwinds. This feature is provided in the most part by the effectiveness of the adaptive thresholding in reducing the angle false-alarm rates. To remove false-alarms due to stationary targets, output for targets which correlate with tracks, but which never move more than 1/4 nmi (1/2 nmi en route) from the position of track initiation are suppressed.

Processing employed in this module is straightforward. First, input targets are associated with tracks on the basis of a normalized error distance from the track predicted position. Non-unique track-target associations are then resolved and targets correlating with tracks older than two scans are output to the display system. The tracks which have been correlated with a target are updated using the target quality to determine the amount of smoothing to be used in the azimuth prediction. Tracks not associated with targets are "coasted" for up to 3 scans (depending on age) and are then dropped. All uncorrelated targets which are not low-confidence are retained for use in starting new tracks on the next scan. The current implementation of the MTD tracker uses α , β smoothing (α , β dependent on target quality) in an x,y coordinate system for track prediction when the track is at ranges less than 6 nmi, and a ρ , θ coordinate system when the track is outside this range.

2. Output Processing

Experience has shown that greater than 98% of the "real" moving A/C target reports (an average of 60 per scan are input from C&I) that are input to surveillance processing are output for display, while fewer than one per scan of false alarms (birds, clutter, weather) are output for display.

Target report dissemination rules have been retained as operator variables to explore their effect on real-time use. High-confidence target reports may be displayed, without regard to track association, within mapped geographic areas. This feature was used near runways, to allow controllers to "see" first and second reports of departing traffic, rather than wait for the third report, which started a track and would be the first report displayed. Target reports with the "moving ground traffic" confidence flag set were not displayed. However, since this introduces "black holes" in coverage (geographic - static map), some controllers would have preferred the option of displaying these targets. This option could be included in future systems. At BTW, digitally formatted target reports and weather contour data were transmitted to the TRACON, to be reconstituted as video, for display on the ARTS-2 PPI.

AT BTV
30 dBz GROUND CLUTTER (FILTERS 0-7)
NO RAIN

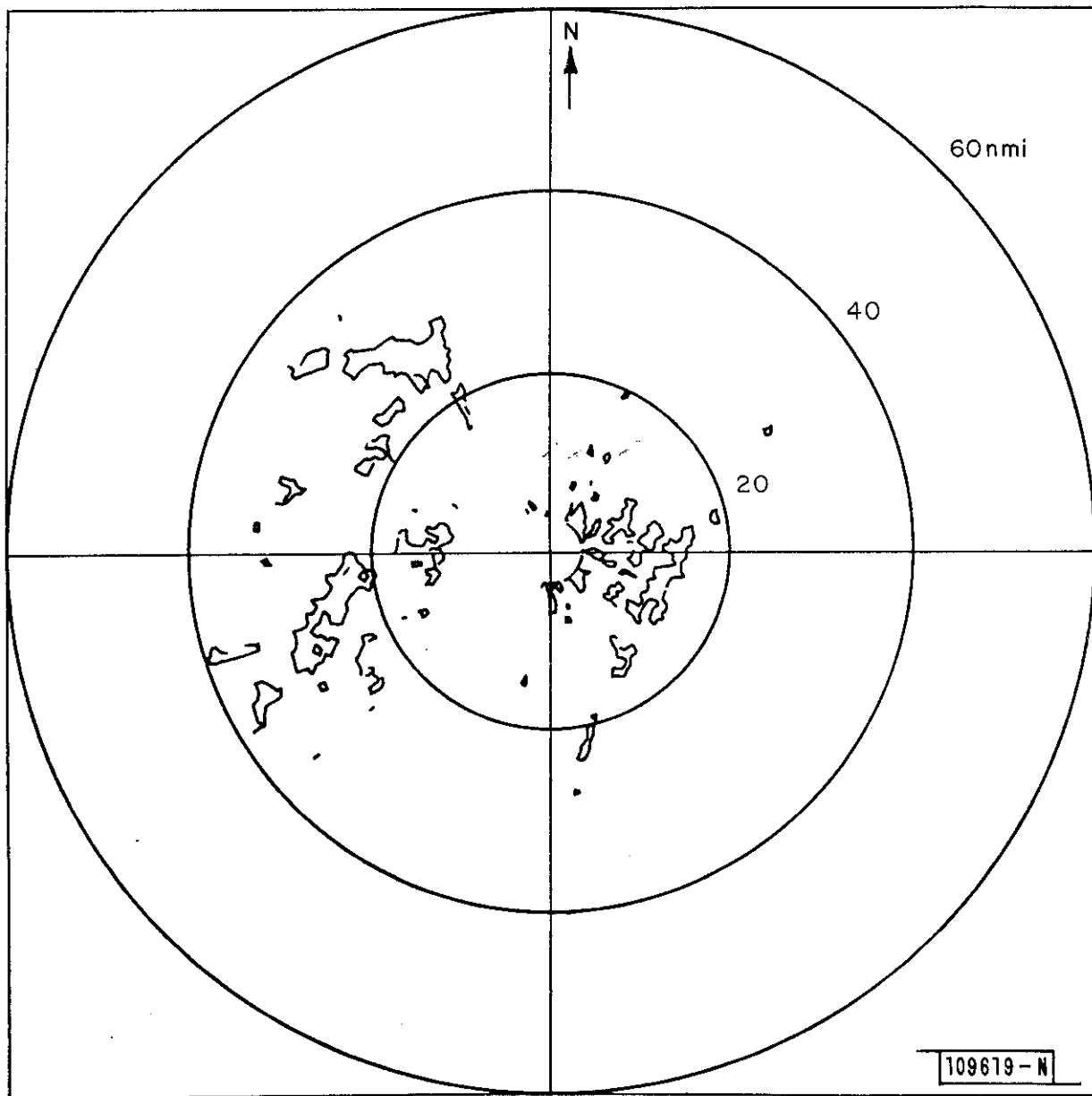

Fig. II-6a. Weather contours (30 dBz) due to ground clutter at Burlington, VT.

AT BTV
30 dBz GROUND CLUTTER AND RAIN (FILTERS 0-7)

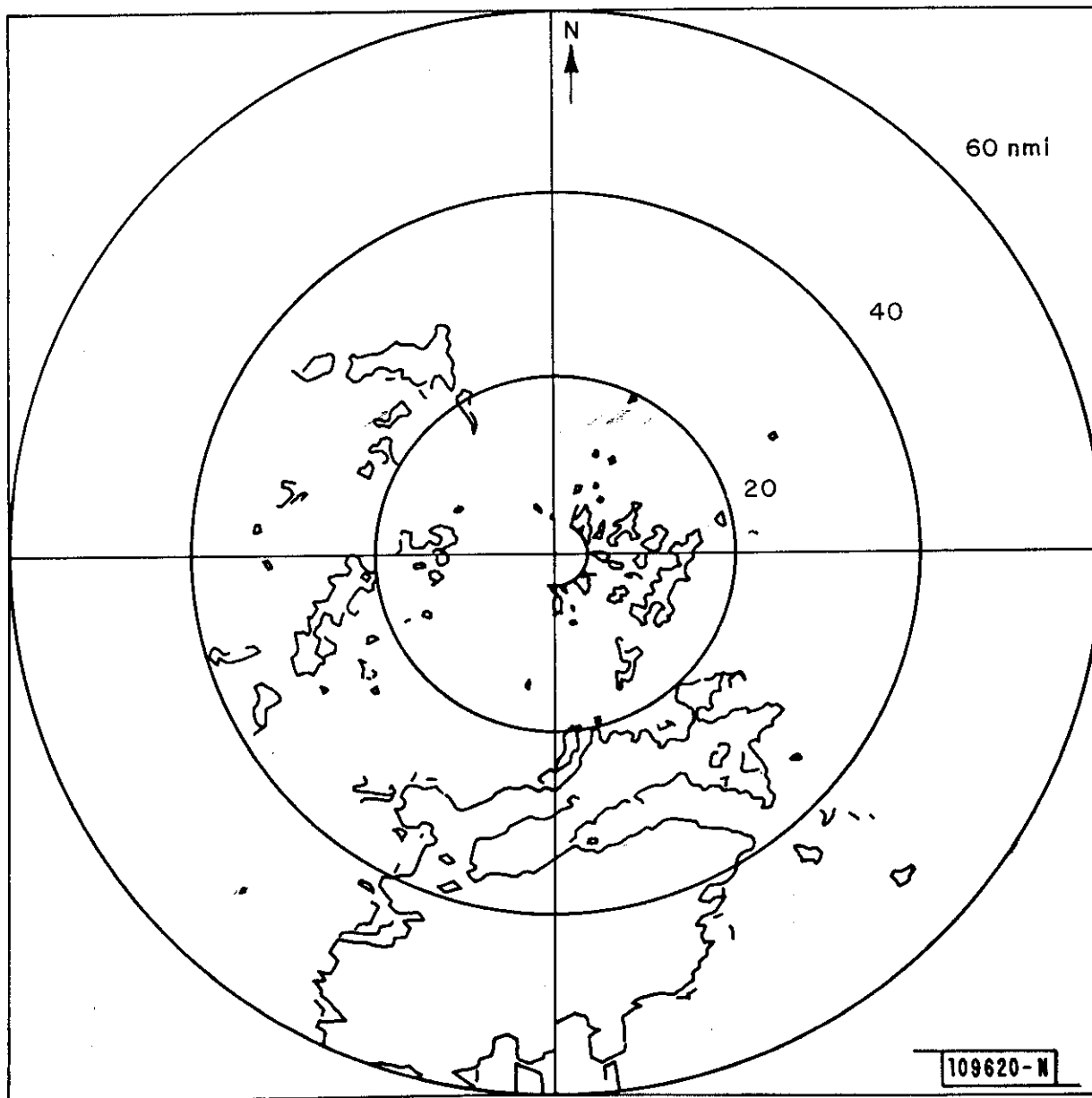

Fig. II-6b. Weather contours (30 dBz) due to rain and ground clutter at Burlington, VT.

AT BTV
SMOOTH 30 dBz CONTOURS
FILTERS 0-7 OR 1-7 SELECTED USING 30 dBz MAP

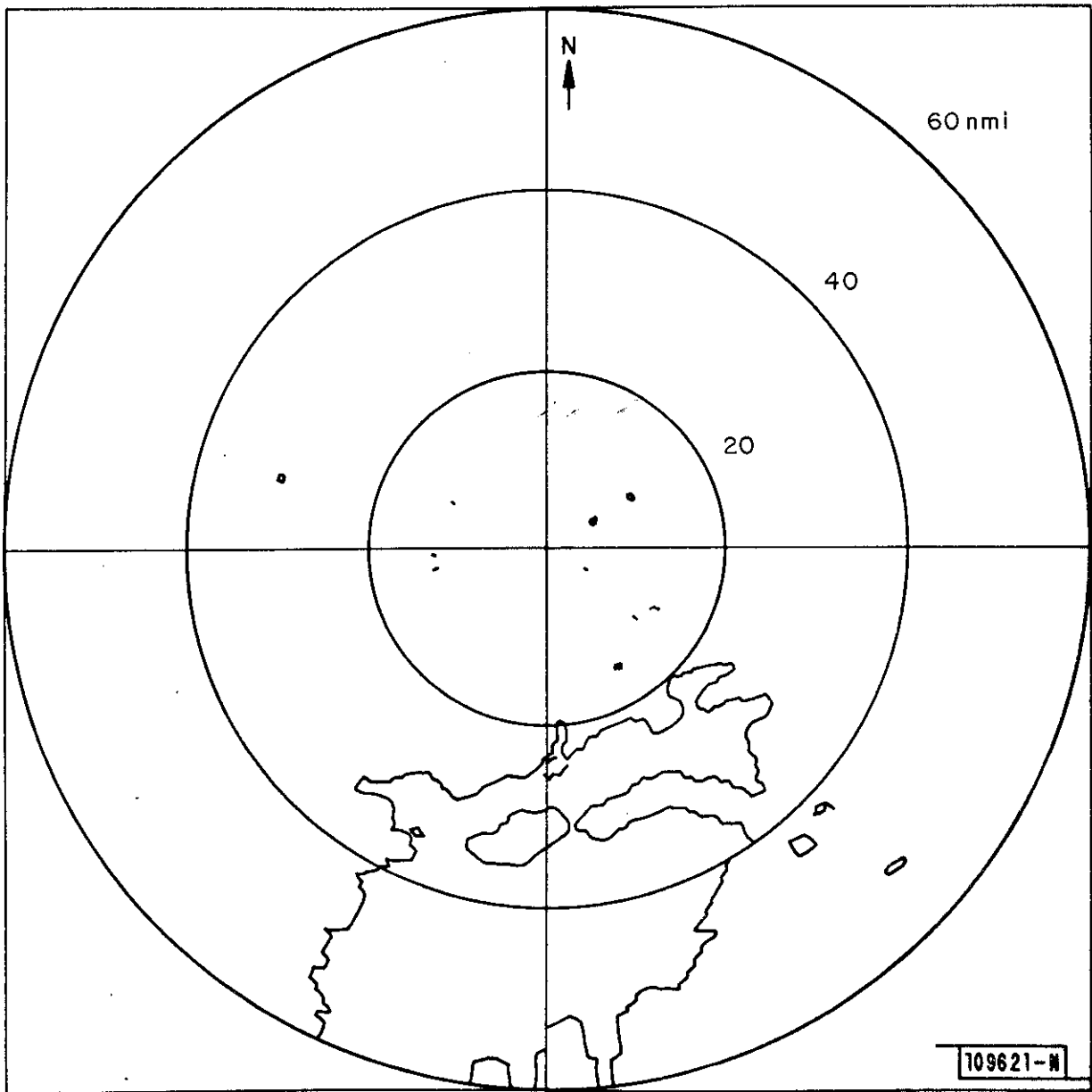

Fig. II-6c. Weather contours (30 dBz) due to rain and ground clutter rejected at Burlington, VT.

AT BTV
SMOOTHED 30 dBz CONTOURS
FILTERS 1-7

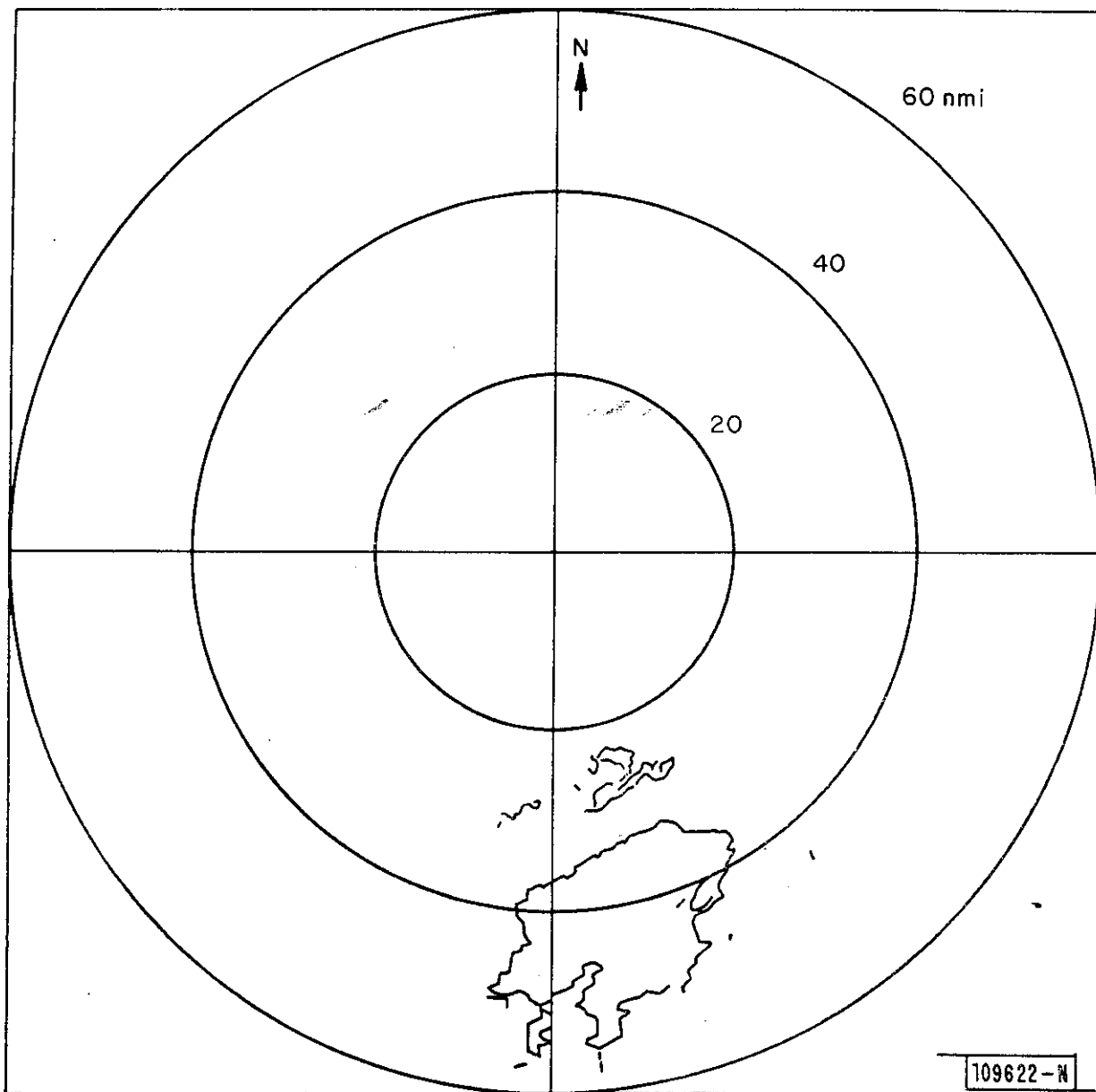

Fig. II-6d. Weather contours (30 dBz) using only the higher pass filter at Burlington, VT.

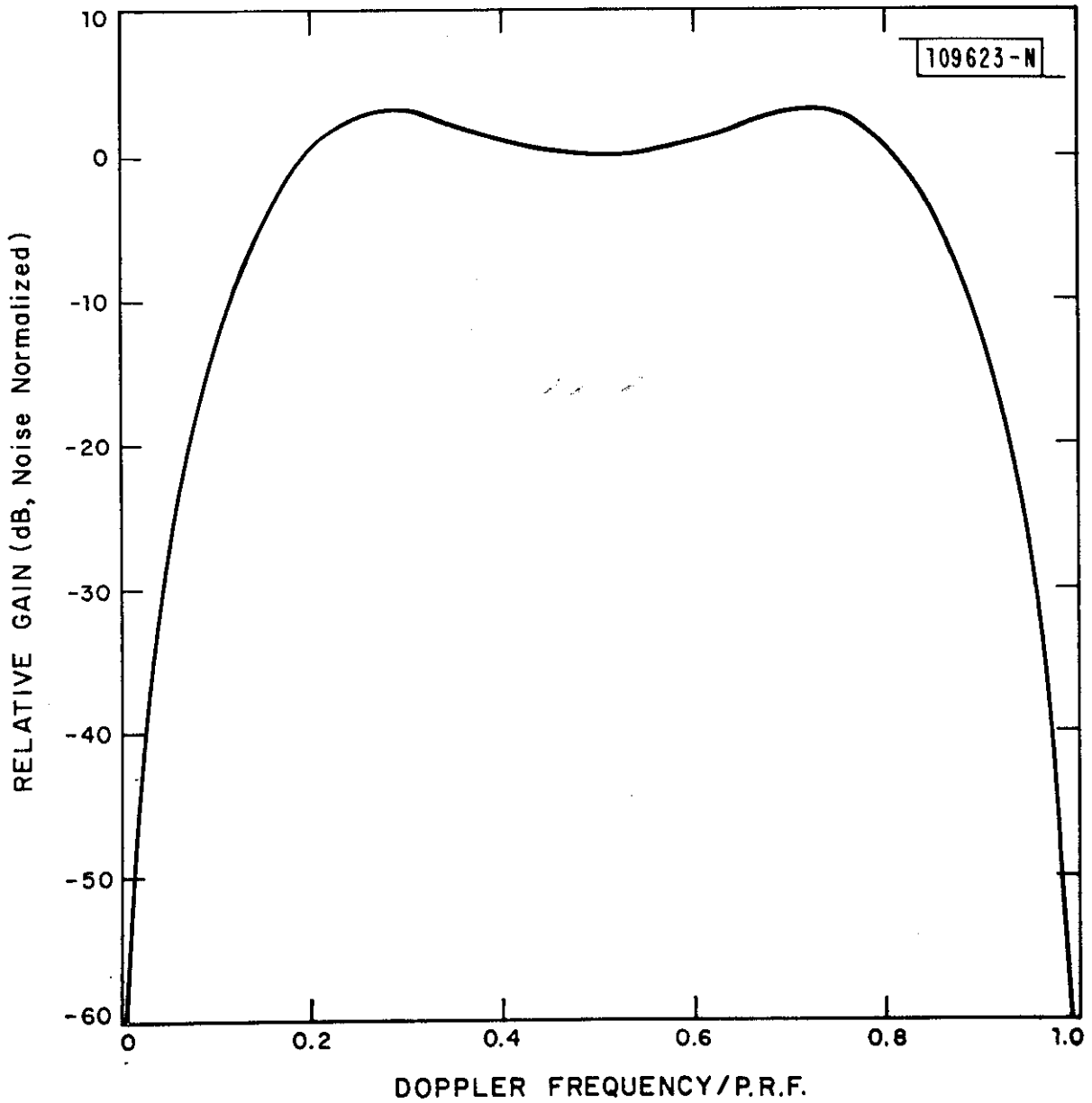

Fig. II-7. Frequency response of high pass filter.

III. PERFORMANCE EVALUATION

A. Introduction

MTD-II processor systems have been extensively tested at three FAA radar sites. Complete MTD-II systems (signal processor, C&I processor and surveillance processor) have been tested using the Burlington, VT, airport ASR-7 terminal radar and the Bedford, VA, FPS-67 en-route radar. An MTD-II system consisting of the signal processing and C&I subsystems have been installed and operated at FAATC, Atlantic City, NJ, to provide primary radar target information to a Discrete Address Beacon System (DABS) radar/beacon surveillance processor. All sites had the capability of making digital tape recordings of the signal processor primitive target and weather declarations as well as C&I and surveillance processor outputs, so that algorithmic changes to the post detection processing algorithms could be evaluated in non-real time using actual primitive target data. In addition, the performance of the MTD-II surveillance processor with FAATC data was evaluated even though that function was not performed by the MTD system at the time of the data collection.

Due to differences in existing equipment at the sites, the attempted performance analysis differs from site to site. For example, due to the lack of an automated beacon system with recording capability at Burlington, VT, it is not possible to provide target population probability of detection statistics as at the other sites. Available at the FAATC site was a high precision co-rotating beacon sensor and thus the data set taken there provides the most accurate assessment of MTD-II position measurement performance.

The Bedford, VA, and Burlington, VT, sites were chosen as examples of operational FAA surveillance radar sites where strong ground clutter returns have been encountered. The FAATC site was chosen principally because of the presence of the DABS beacon sensor, however, the almost constant presence of echos due to birds made it a good location for testing algorithms designed to control false-alarms due to that cause.

B. Burlington, VT (BTV)

1. Installation and Site Description

The Burlington, VT MTD-II installation consisted of an MTD processor connected to one of the two operational ASR-7 radar channels using a diplexer so that simultaneous comparisons could be made between the ASR-7 normal/MTI video output and the output of the MTD processor. A block diagram of the installation is given in Fig. III-1. Modifications made to the ASR-7 radar to provide a test bed suitable for the MTD processor are listed in Table III-1. Presentation at the TRACON of MTD output reports was accomplished with the generation of a "reconstituted" radar video where the digital MTD output after being transmitted from the radar site to the TRACON over a serial line, is used to produce a true video signal which was then sent to a standard ARTS-II ATC

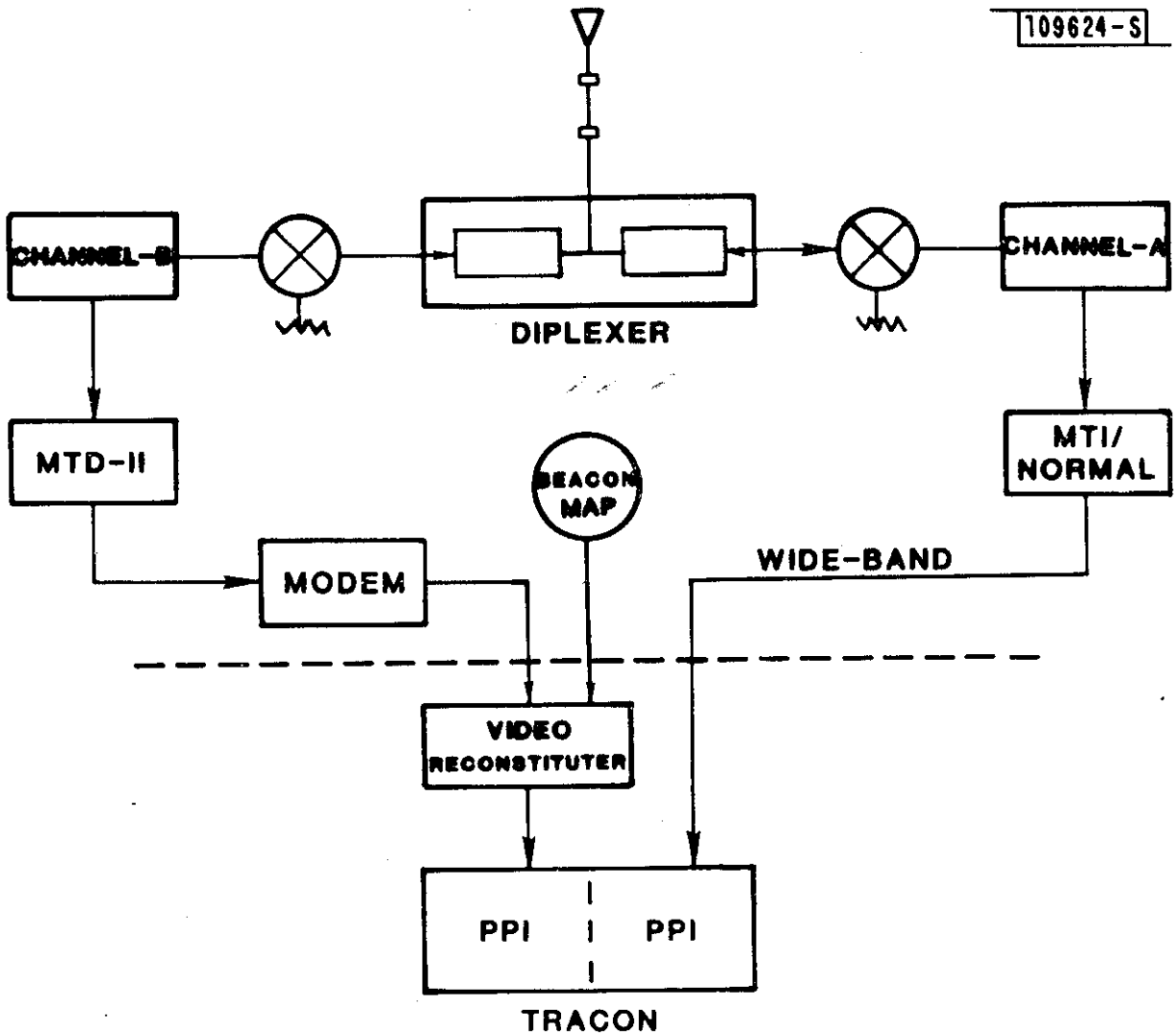

Fig. III-1. ASR-7 MTD/MTI at Burlington, VT Functional Block Diagram.

display. A process of reconstituting the video is described under 3.4.8 of Appendix A. The MTD surveillance processor requires approximately 1.5 seconds for target association and output so that the map video, beacon video, and azimuth information given to the display console must be delayed by that amount. When the MTD is in operation the two transmitters transmit asynchronously, requiring that the MTD processing be blanked when the ATC channel transmits, and the corrupted MTI and normal video in the ATC channel to be blanked when the MTD channel transmits.

Table III-1
ASR-7 Modifications to Permit Use with MTD

1. Replace existing STALO with highly stable, crystal-controlled oscillator meeting requirements of 3.4.1.2 of Appendix A.
2. Equip the transmitter magnetron with automatic tuning provisions such that the AFC circuitry can keep the magnetron operating at the proper frequency.
3. Add a directional coupler in the COHO line so that the MTD processor can be provided with a sample of the COHO signal.
4. Modify the ASR-7 STC characteristic (realignment).

Burlington, VT, see Fig. III-2, is a site characterized by extreme amplitude ground clutter. Figs. III-3 and III-4 show a map of the ground clutter echoes exceeding 30 dB (single pulse) signal-to-noise and the cumulative amplitude distribution of resolution cells where clutter exceeds the processor single pulse input dynamic range of 51 dB. Few roads are visible from the radar site due to its location on a relatively low tower in the airport infield. Unfortunately, the only major roadway visible, I-81, requires blanking a cell approximately 1.5 nmi from the radar directly on the approach of Runway 33, the main runway at the airport. This often results in a loss of detection of 2-3 scans for landing aircraft. A plot of the fixed threshold map used for large amplitude ground clutter and visible roadways is given in Fig. III-5.

2. General Performance

The basic goal of the MTD development was to produce a radar target surveillance system with high detection probability and a consistently low false alarm rate. The experience at Burlington, VT, indicates that this can be achieved at a site where extreme ground clutter is present. Figs. III-6a and III-6b show 100 scan (approximately 8 min.) plots of typical periods of the Burlington terminal area traffic. The terminal MTD is designed to produce, and in fact achieves, typical false-alarm rates of less than one per scan, and

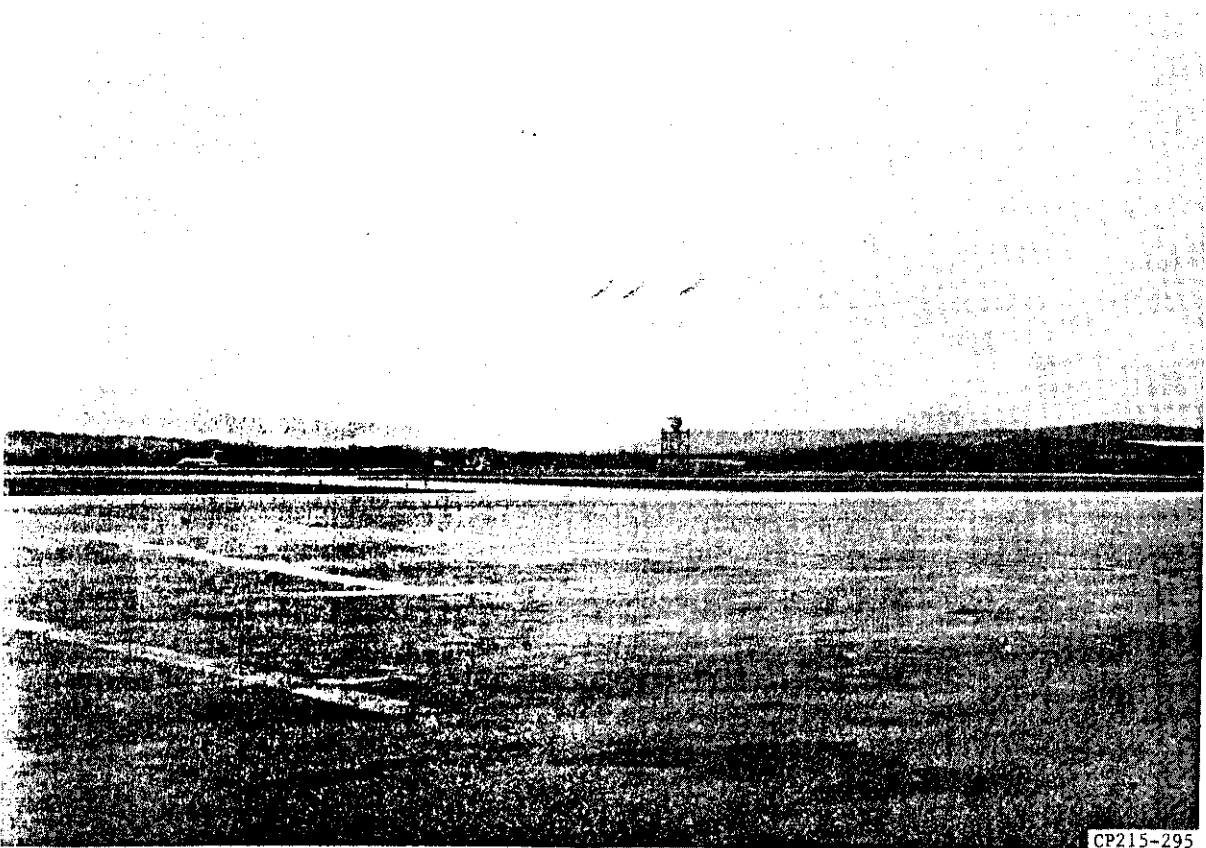

Fig. III-2. Burlington, VT (BTV) ASR-7/MTD site.

109625-S

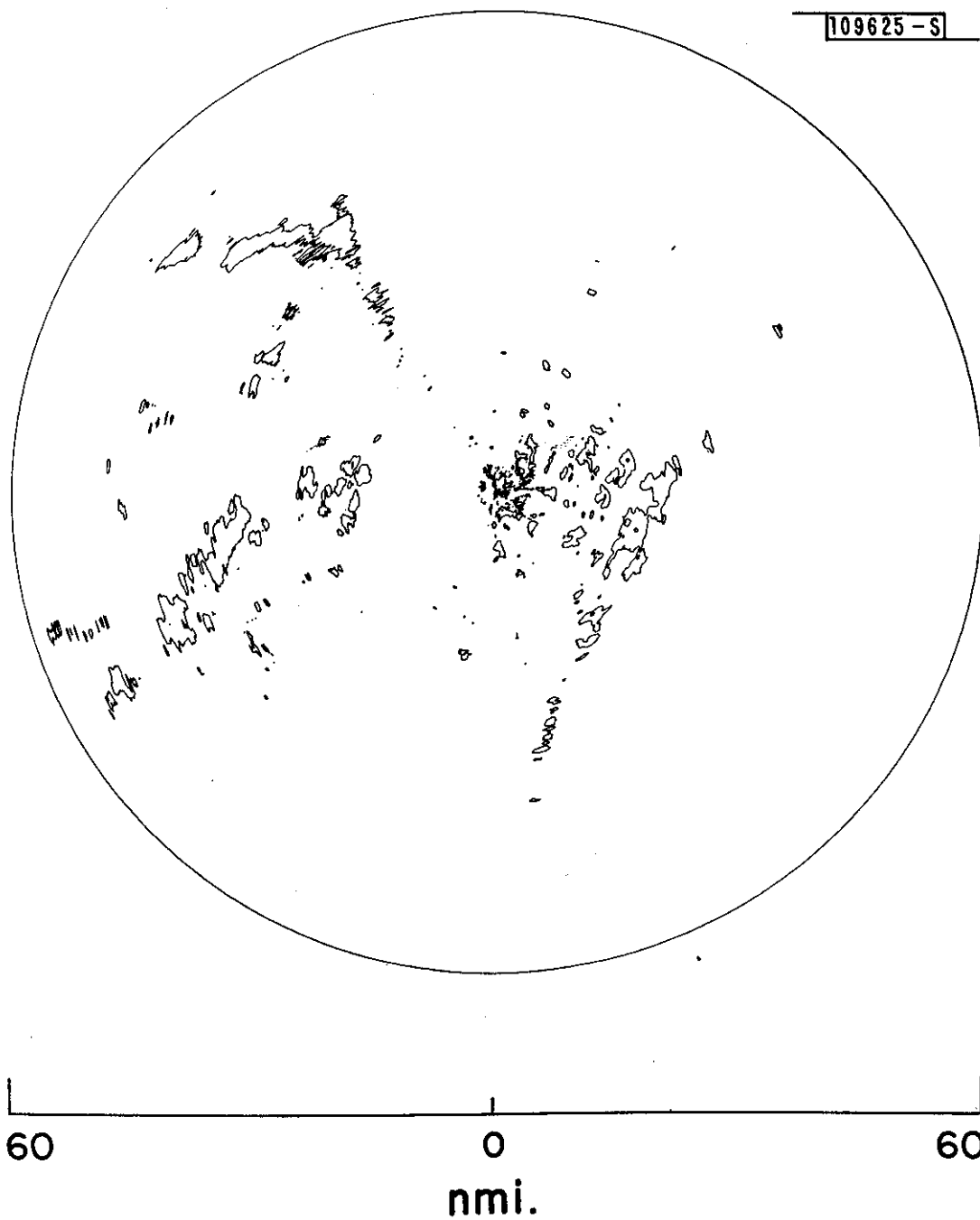

Fig. III-3. Ground clutter (40dB S/N) at Burlington, VT.

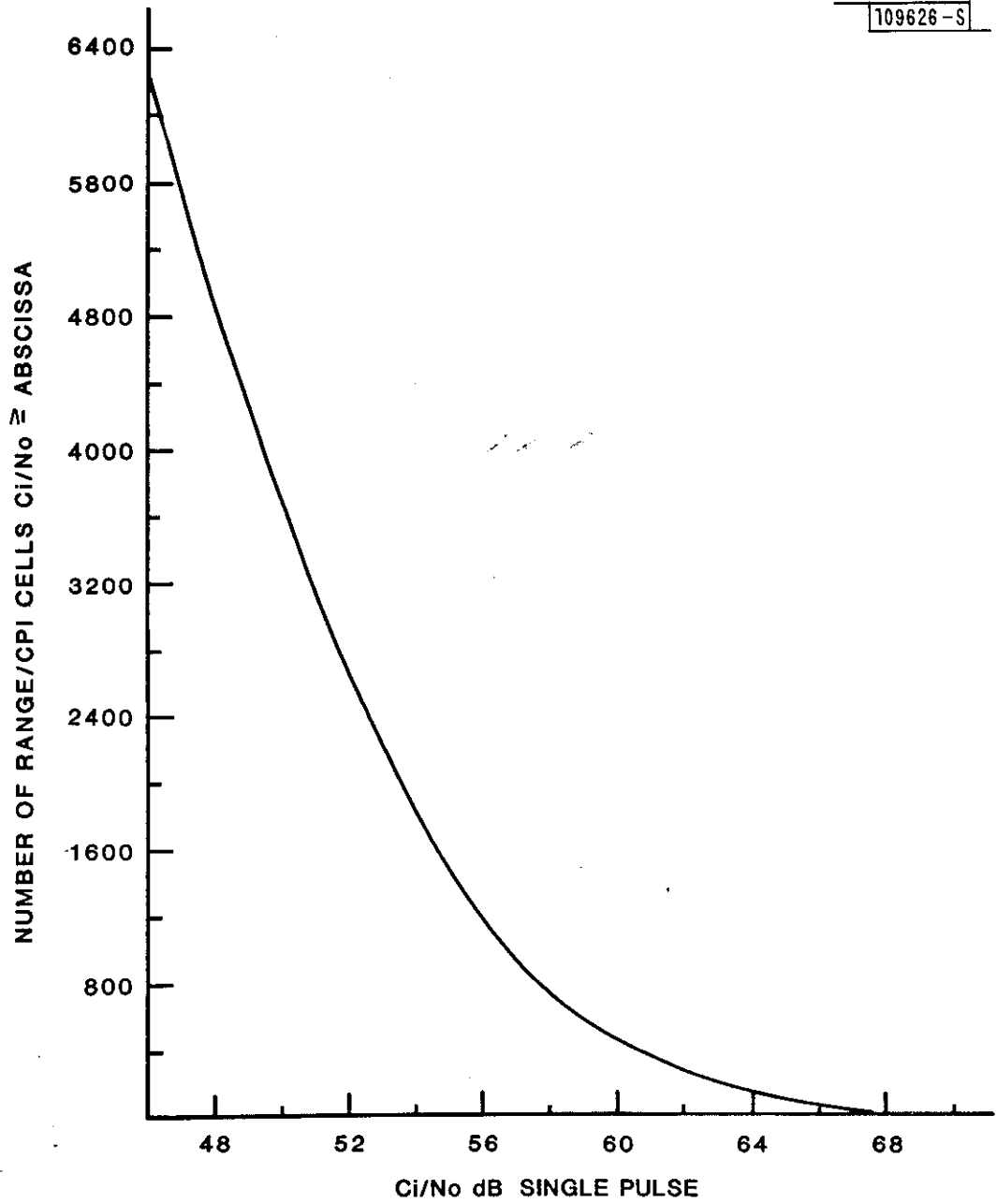

Fig. III-4. Ground clutter characteristics at Burlington, VT.

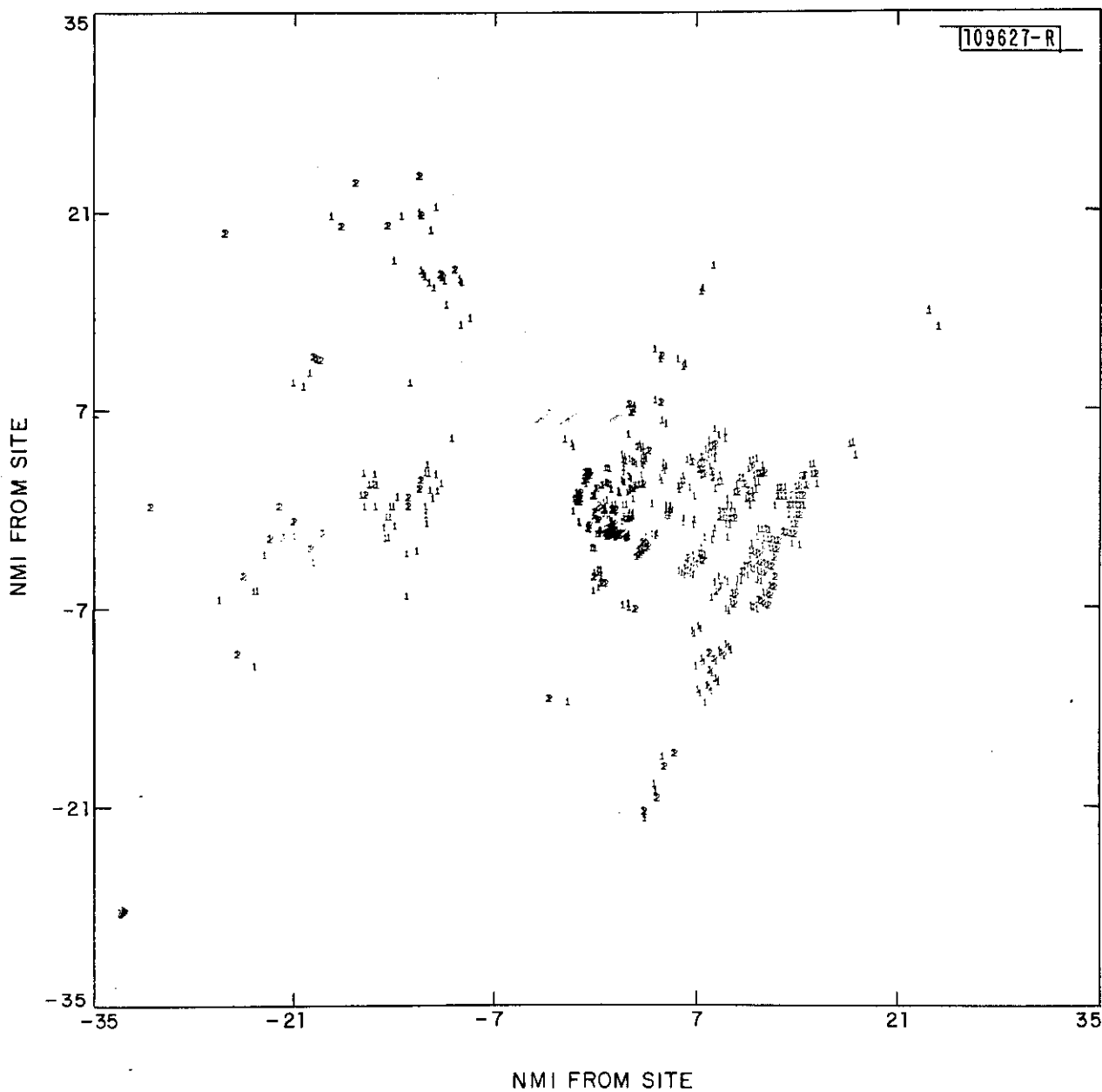

Fig. III-5. Real-time system - fixed threshold map for Burlington, VT.
 (1 = low level threshold, 2 = high level threshold)

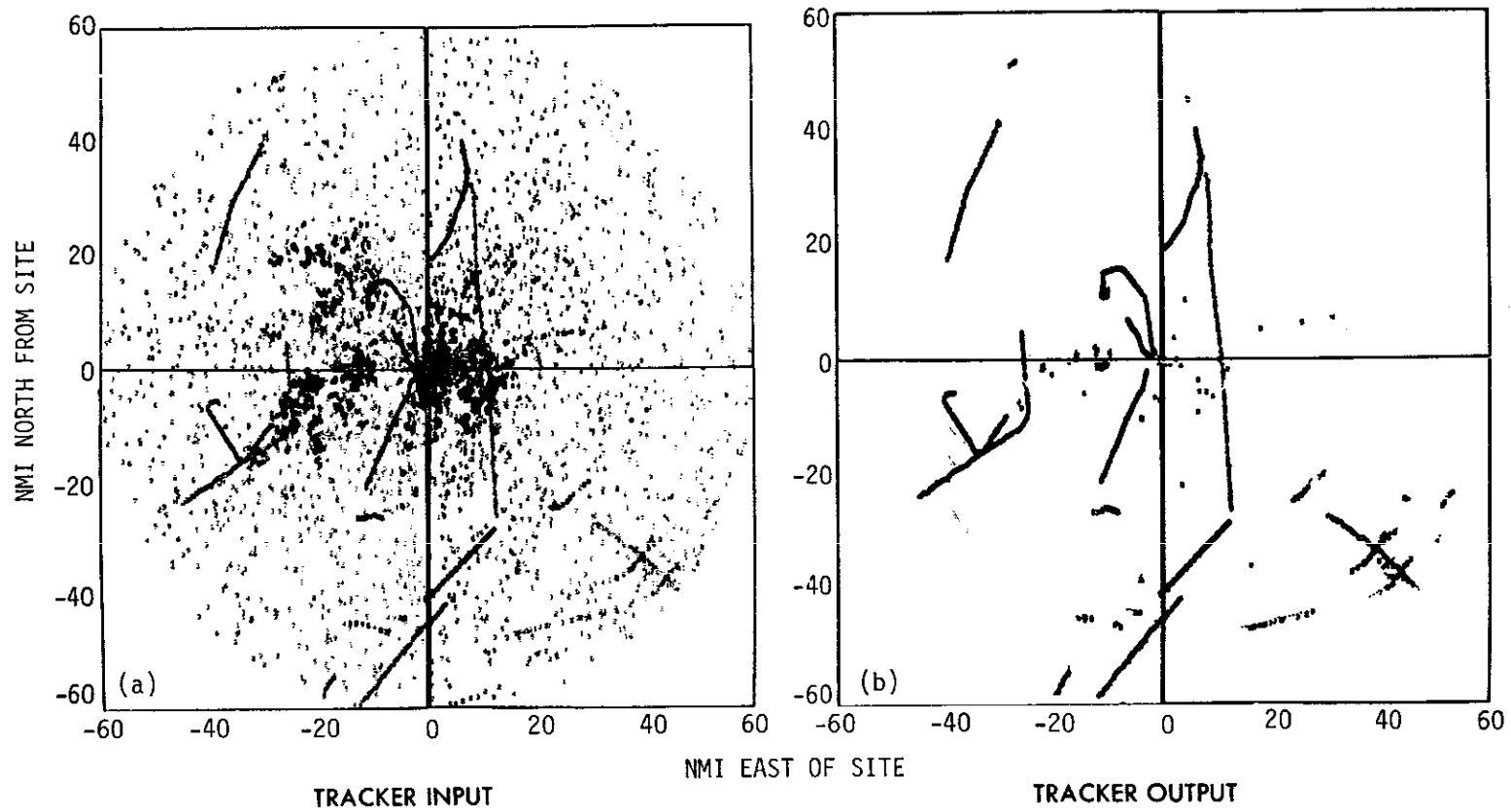
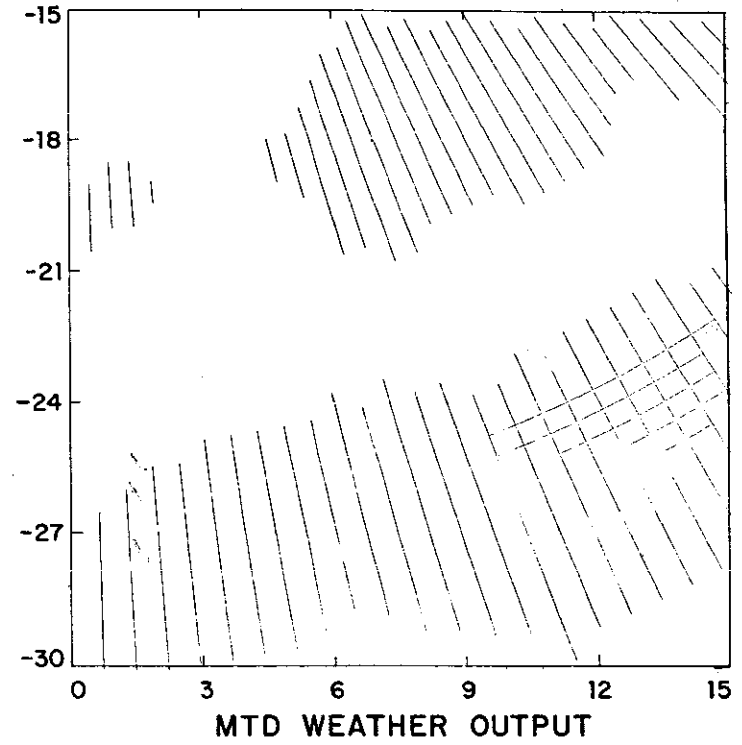
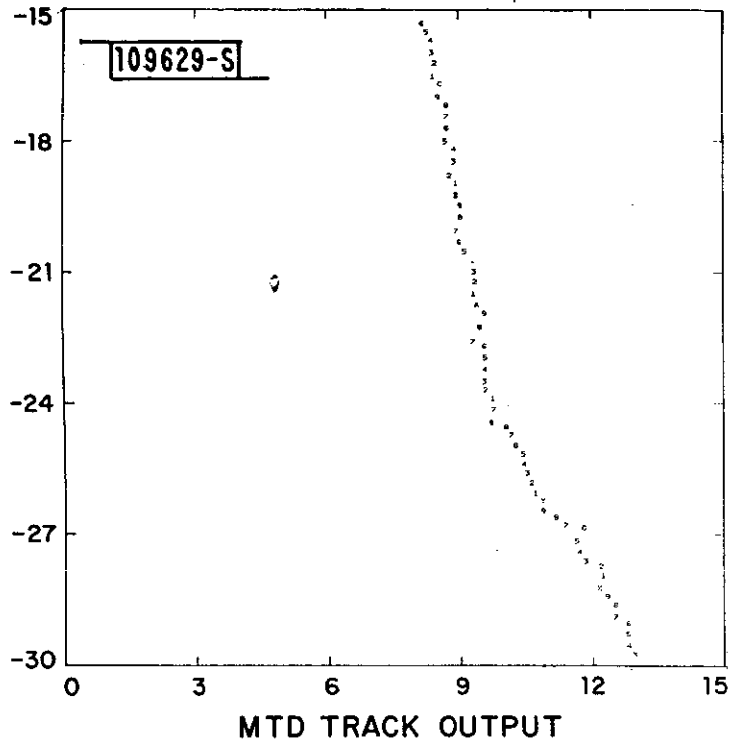

Fig. III-6. MTD targets and tracker output (100 scans, 60 nmi radius).

6-III



SHADED AREAS 30 dBz RAINFALL, CROSS-HATCHED 40 dBz

Fig. III-7. MTD performance in rain.

peak false-alarm rates of less than 10 per scan in adverse conditions (extreme angles, fast moving small scale weather). There is not an automated beacon system at Burlington, so that detailed analysis of detection probability must be made using flight test data, or, data from aircraft where the aircraft altitude is known. However, on the basis of targets-of-opportunity, as in the previous plots, it is clear that for most targets the detection probability is near unity. Figure III-7 shows the track of a target-of-opportunity in rain clutter. The rain return in this data represents an input rain/noise power ratio of from +25 to +30 dB.

The MTD-II was operated at BTV for a period of approximately 18 months, starting in July 1978. During the period April-October, 1979 considerable dedicated flight testing for performance comparisons were effected, and although recordings of beacon data were not available, knowledge of the presence of the target aircraft within radar coverage enabled determination of detection statistics. The flights were generally conducted using small general aviation aircraft (cross-section varied from -3 dBSM to +8 dBSM), and followed trajectories over areas of large ground clutter. For the controlled tests, where most of the missing target reports were associated with extreme clutter areas, or Channel-A interference blanking of the MTD processor, the MTD-II detection probability was greater than 0.94. The channels were operated asynchronously, and each interfering pulse blanked an 8-pulse CPI. A typical test aircraft track is shown in Fig. III-8 where the trajectory includes high amplitude ground clutter to the northwest and the southeast of BTV. Some tangential legs are included to test the processing of zero-velocity targets, using the clutter map.

This is not to say, however, that the MTD processor can detect any target over any area of clutter. There are cells at Burlington where the clutter amplitude exceeds 70 dB S/N (areas principally to the east 12 - 14 nmi in range). For reasons related to radar system stability (see Section 4) the maximum sub-clutter visibility (SCV) possible at Burlington is approximately 36 dB. At low doppler velocities, achievable SVC is somewhat less. Thus there are instances, some of which are identified below, in test flights where small targets over large clutter are not detected with high probability. In spite of this the target-of-opportunity data does indicate that the MTD detection performance in clutter is sufficient (> 0.94) for the traffic normally encountered in the area.

C. FAATC - Atlantic City, NJ

1. Installation and Site Description

The FAATC MTD-II installation was performed principally to provide a source of target reports (C&I output) to a DABS sensor for use in the development and testing of algorithms implementing a combined radar/beacon surveillance processor. A block diagram of the installation is given in Fig. III-9. The ASR-7 at this site is a single channel radar used for engineering

III-III

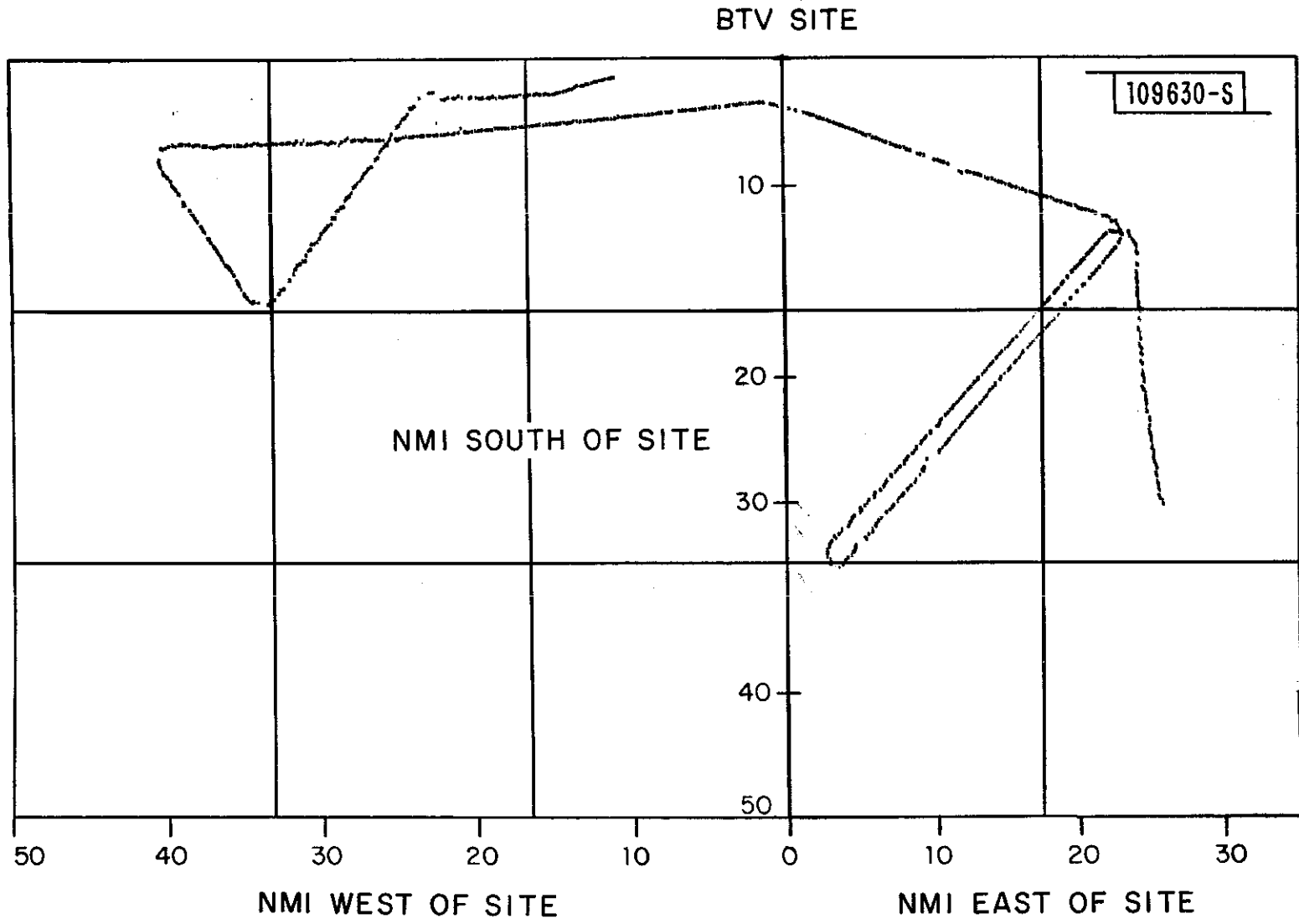

Fig. III-8. Track of test aircraft at Burlington, VT.

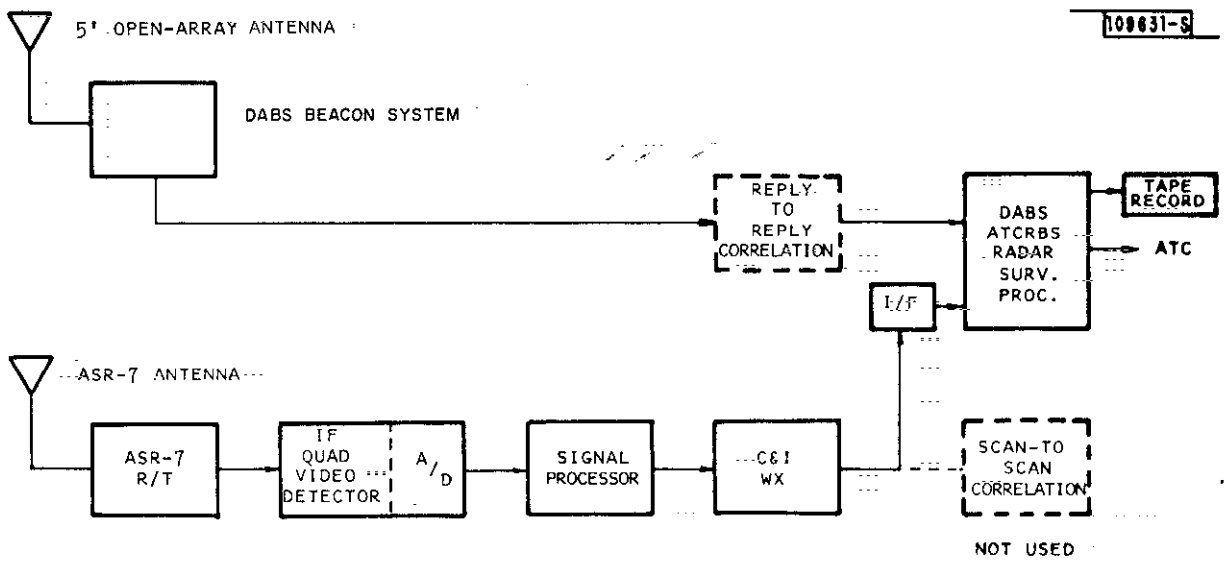

Fig. III-9. MTD/DABS at FAATC, functional block diagram.

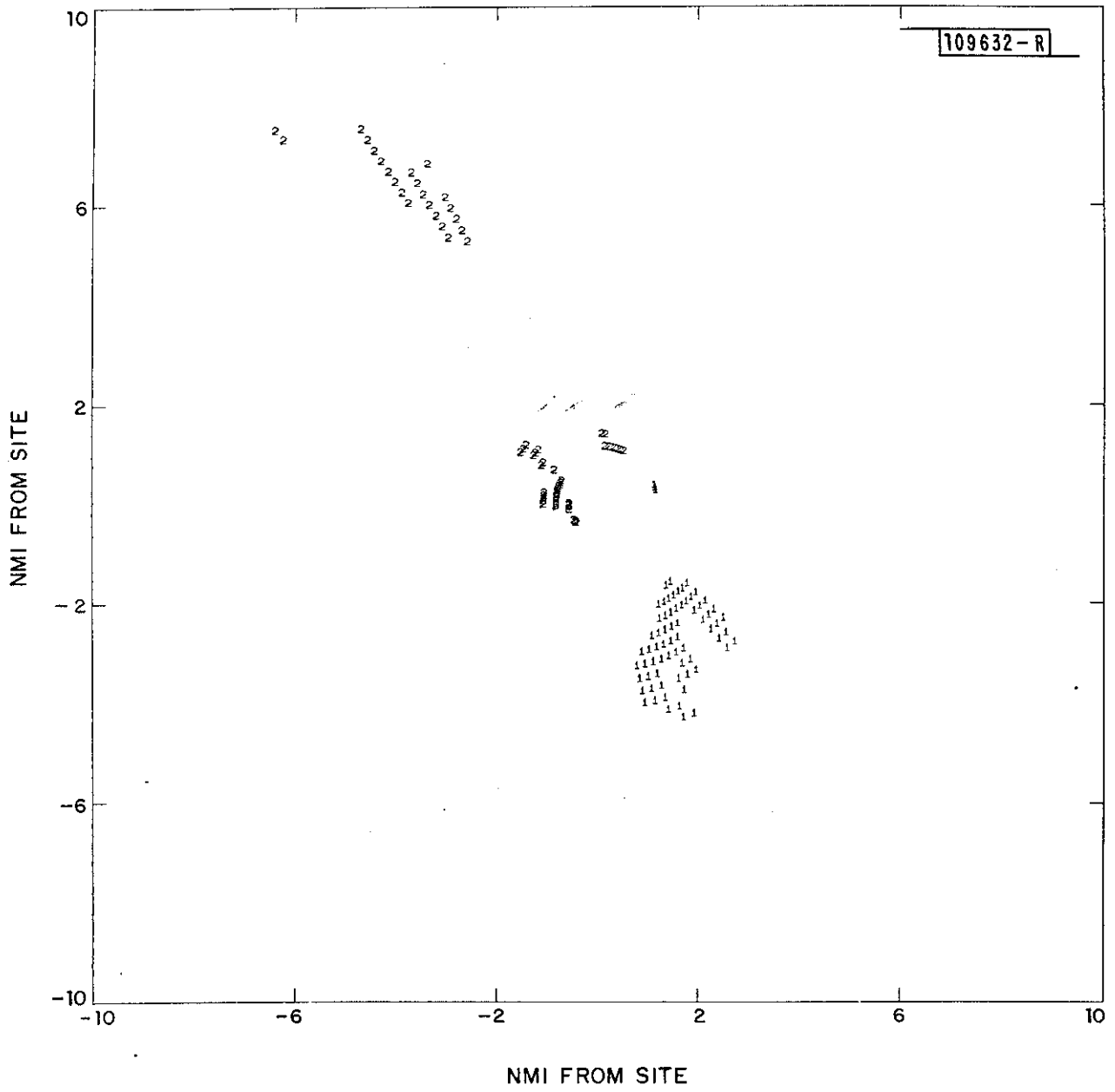

Fig. III-10. Threshold map, MTD/DABS at FAATC (1 = low level threshold, 2 = high level threshold).

purposes. Its principle function is to provide radar support for the DABS sensor. The presence of the co-rotating DABS beacon permits automatic analysis of MTD position accuracy and MTD target detection probability for targets which meet evaluation angle screening criteria. The FAATC site is also a good source of data for design of algorithms to deal with bird-related false alarms. A plot of the FAATC fixed threshold map is given in Fig. III-10. There is no ground clutter at this site large enough to produce a significant filter bank mismatch and the relatively few fixed threshold cells used are all due to visible sections of roads.

2. Performance

Samples of radar/beacon automated surveillance output are shown in Fig. III-11a, and b, where the alphanumeric characters are used to indicate scan number, repeated at intervals of 260. The first figure shows MTD target reports and the second shows reinforced target reports and radar/beacon-only reports. Overall performance for targets within the coverage of the sensor is $P_d = 0.99$. The beacon system alone was generally 0.97, and the MTD alone was 0.94.

The radar-only false-alarms, within about 12 nmi of the sensor are residual "angel" false targets. There are approximately 40 false-alarms (about one per scan) in this sector, and there would therefore be about four false-alarms per scan total. During this operation, there were in excess of 2500 "angel" primitive target declarations per scan, the remainder being removed by adaptive fine/coarse grain thresholds. The fast-acting coarse threshold was subsequently increased to further reduce the bird false-alarm rate, and a factor of two was achieved, without an important reduction in sensitivity to A/C targets. Using targets-of-opportunity within coverage, and the beacon reports as representing "truth" we were able to compute MTD azimuth/range estimate variances, whenever the systems operated simultaneously. During normal operation, a small percentage of the MTD reports fail to correlate with the beacon due to extreme azimuth error (greater than 0.4 degrees), and it is necessary to open the azimuth error (greater than 0.4 degrees), and to open the azimuth correlation window to allow these reports to be used in estimating variance off-line. An example of one such measurement containing about 10^4 samples is shown in Fig. III-12 for azimuth error. The range error was essentially Gaussian with one standard deviation of 200 feet.

3. Additional Results

Data relating to target report quality flags and fine-grain adaptive thresholding (implemented in C&I) were obtained and are presented as examples for this site. Table III-2 shows the result for a sample containing about 10^4 reports, using targets-of-opportunity and the DABS azimuth estimate as truth.

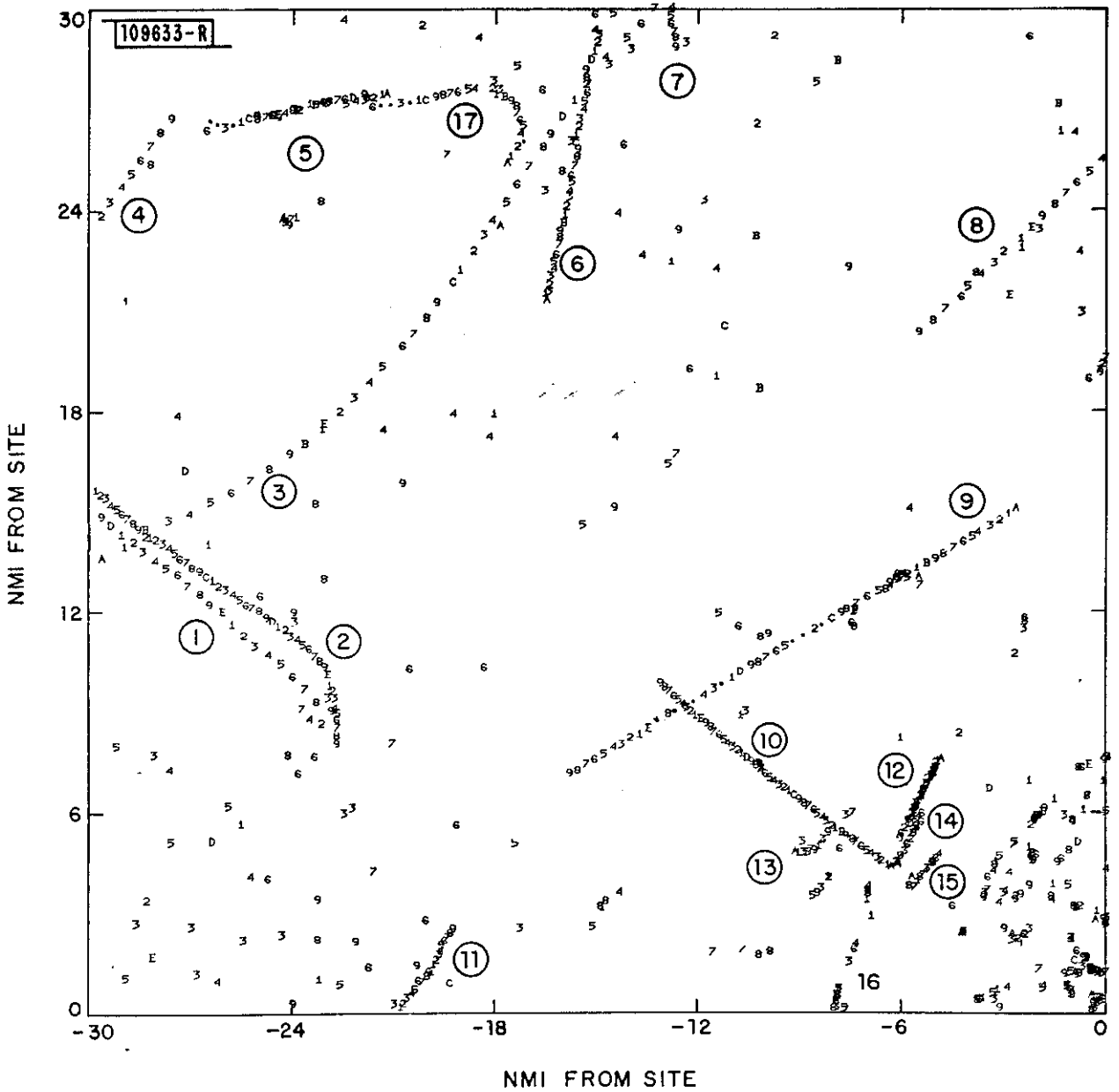

Fig. III-11a. MTD target reports (50 scans) at FAATC.

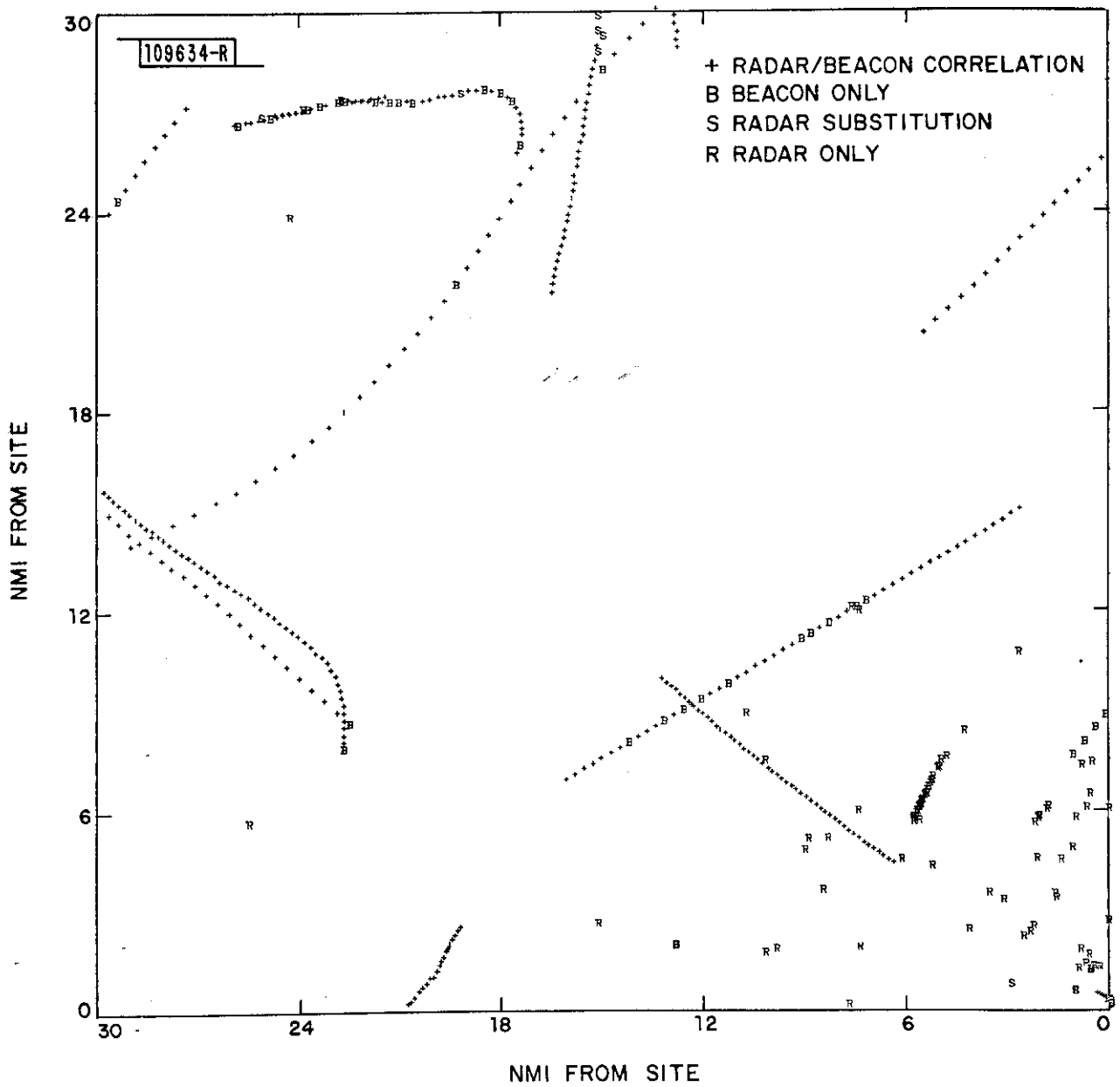

Fig. III-11b. MTD tracker output (50 scans) at FAATC.

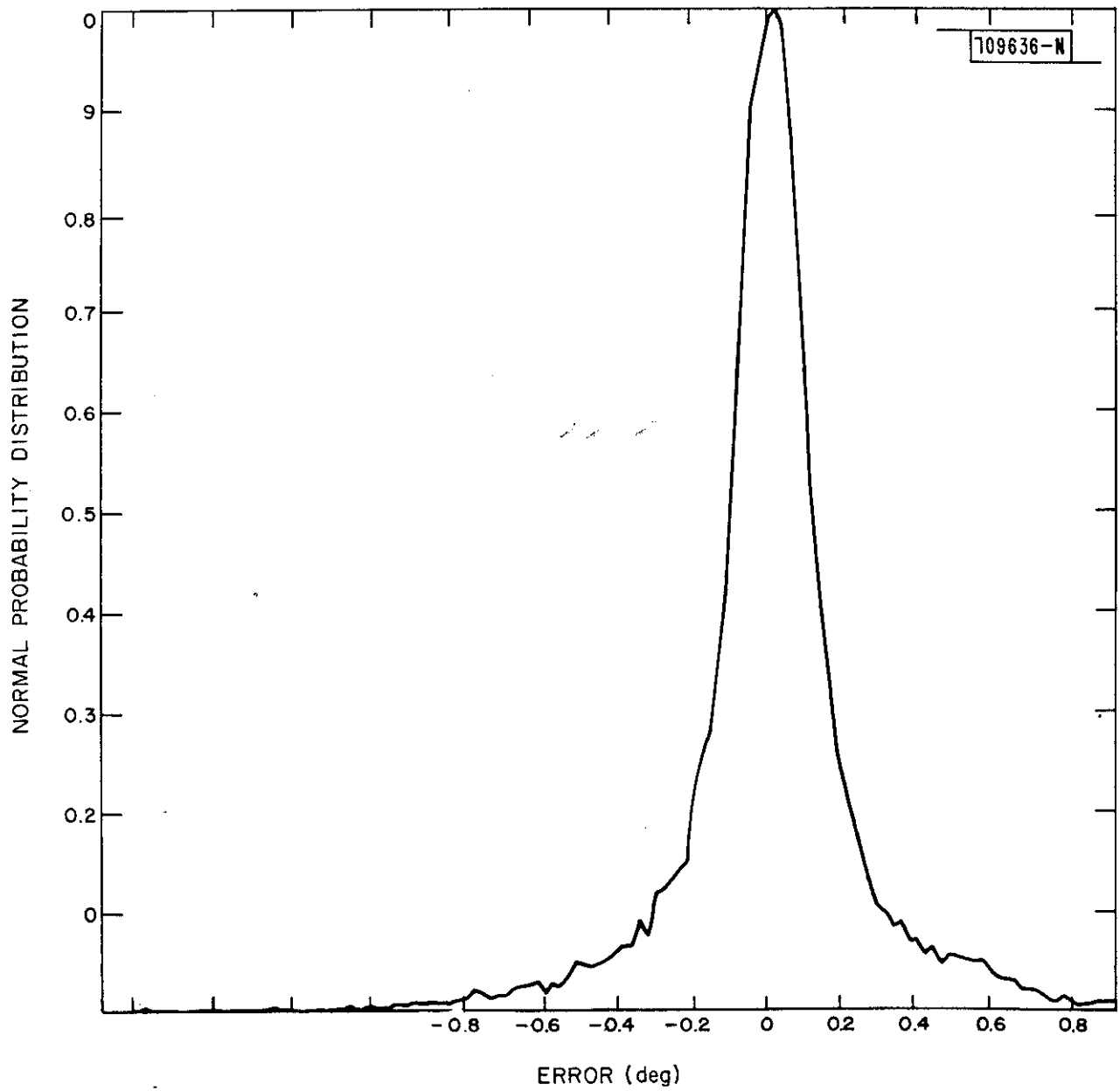

Fig. III-12. Total azimuth error distribution.

Table III-2

<u>Target Quality</u>	<u>Approx. % Observed</u>	<u>Approx. Variance</u>
3	50%	0.09°
2	30%	0.13°
1	13%	0.25°
0 (Single CPI)	7%	0.40°

NOTE: Distributions within quality are only approximately Gaussian.

Figure III-12 shows the overall normalized probability distribution of azimuth error for these target reports, and Fig. III-13 shows the data broken down by quality flag. It is this attribute of the report that adjusts the α , and β smoothing coefficients in surveillance processing tracker update.

An example of temporal adaptivity to bird false alarms is shown in Fig. III-14. This is one of 880 fine-grain adaptive thresholds used to control the rate of bird false alarms which are output from the C&I processor. This is a 4 nmi by 4 nmi cell, and the data shown is for one of the four filter groups being thresholded, the others are zero, 6-7, 3-4-5. The rate of "small" amplitude false alarms start at approximately 6/scan, with the amplitude threshold set at about -28 dBSM. As the threshold is increased to about -15 dBSM, the "small" amplitude false alarm rate is reduced to about 0.3/scan. This cell has about twice the rate of the average cell and would eventually stabilize at a somewhat higher threshold value. The threshold may not exceed -10 dBSM. It is clear from this data that different feedback parameters might allow more rapid settling of the fine-grain thresholds, and allow the fast acting course threshold to be relaxed sooner. This is likely to be site and A/C traffic dependent, and can be "optimized" for each environment experimentally.

D. Bedford, VA

1. Installation and Site Description

The Bedford, VA, installation is similar to that at Burlington, VT, in that the MTD processor fed one of the two operational FPS-67 channels and was operated simultaneously with the ATC common digitizer (CD) in a diplexed (polarization) configuration. At this location too it was necessary to blank the MTD cells affected by the CD channel. The CD, being a run-length detection processor did not require blanking. The output of the MTD surveillance processor was disseminated in CD radar format over a standard CD serial digital line and could be used by enroute centers in the same fashion as CD radar data. A block diagram is given in Fig. III-15. Due to scale size in the signal processor range sliding window CFAR, it was necessary to reduce the pulse width from 6 μ sec to 2.3 μ sec and to increase the receiver bandwidth accordingly.

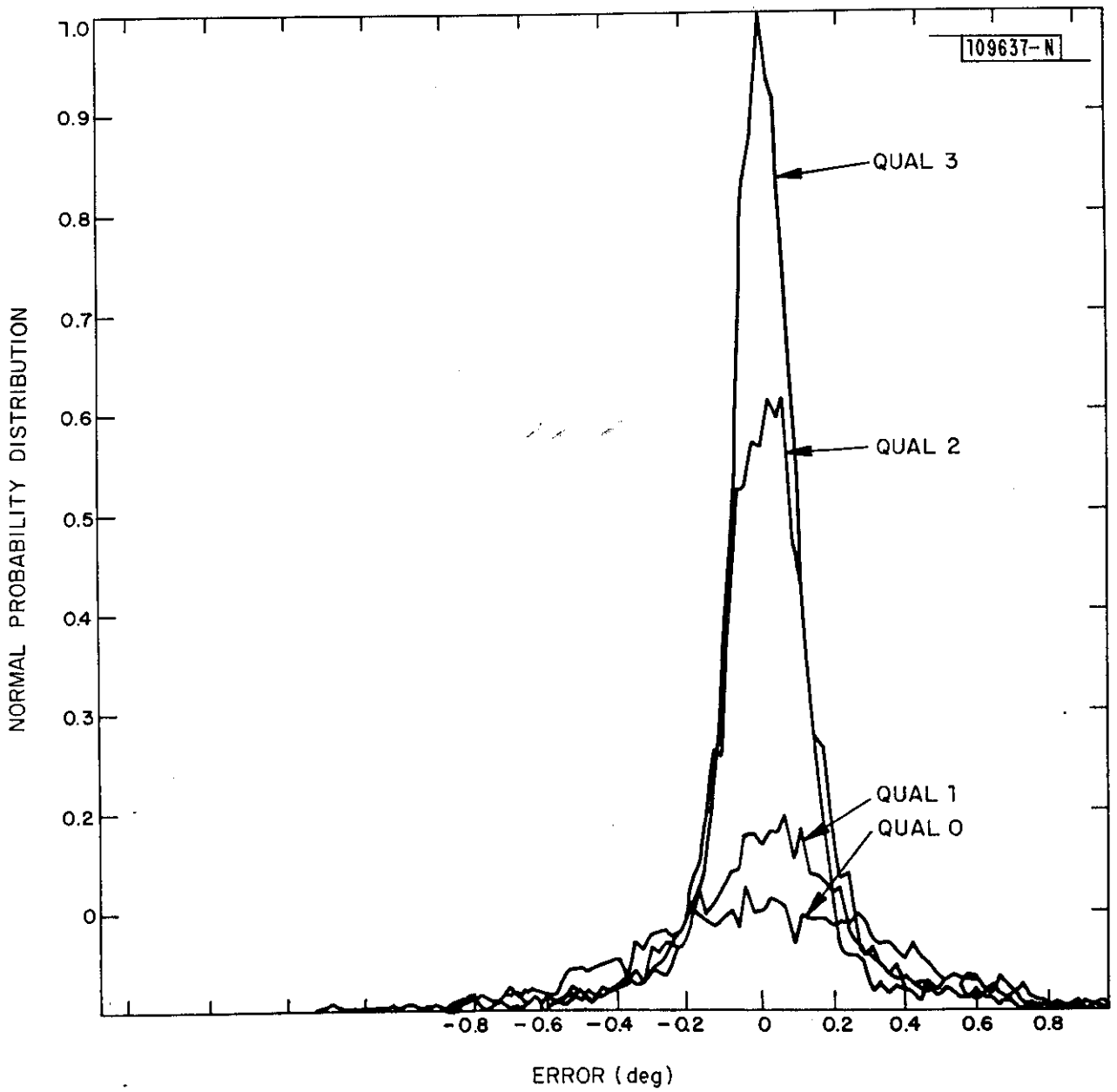

Fig. III-13. Azimuth error by target quality.

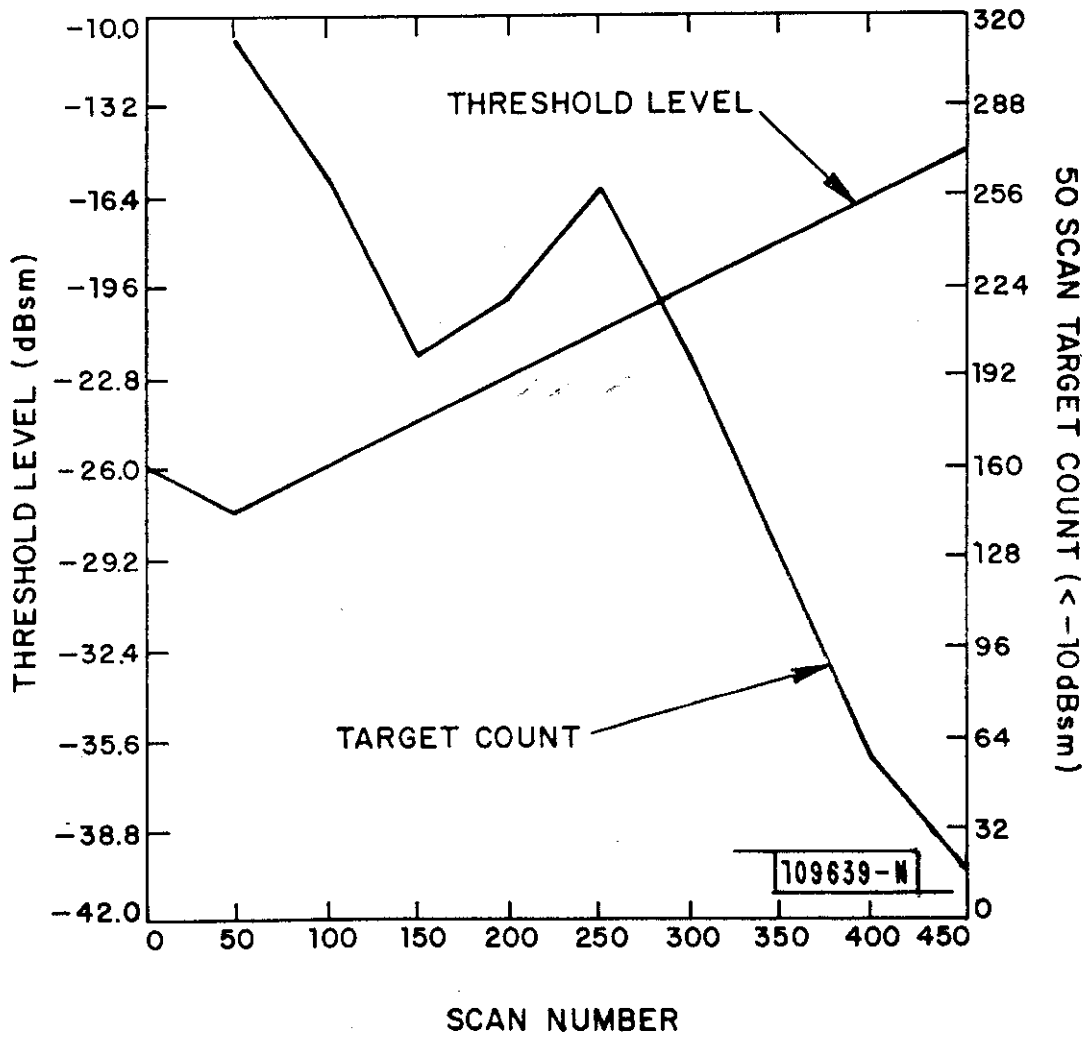

Fig. III-14. Fine-grain threshold cell no. 2 (filter no. 1 & 2).

109640-N

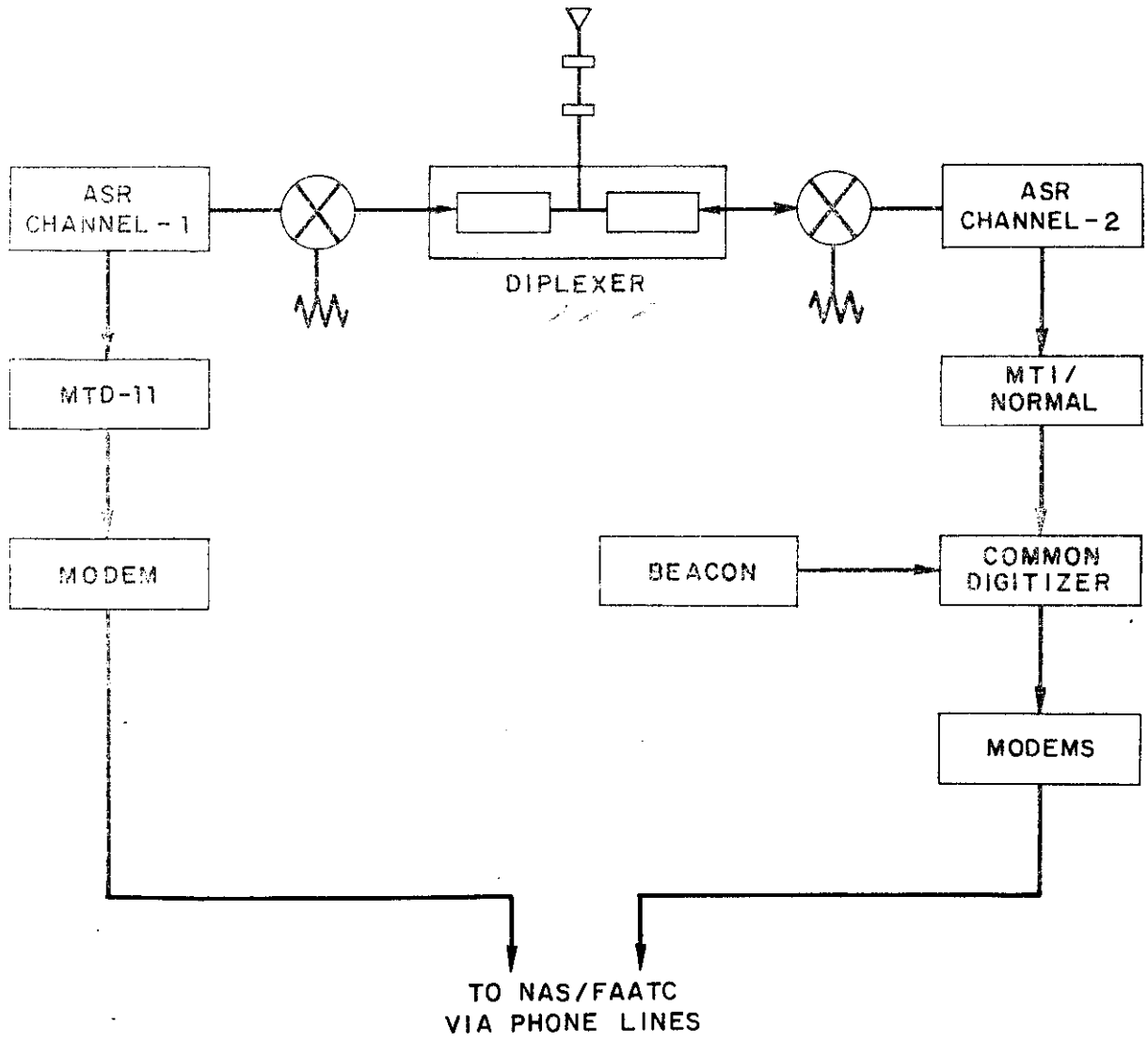

Fig. III-15. Dual system at Bedford, VA, block diagram showing modems.

The Bedford, VA, site is typical of many enroute sites since it is situated at the summit of a mountain (approx. 4200 ft.). It observes ground clutter returns over a substantial area but very few cells are large enough to pose a serious problem to the MTD filter bank (see Fig. III-16). Of more importance is that the siting is such that moving ground traffic is visible over large areas of the radar surveillance space. The fixed threshold map (see Fig. III-17) contains a large number of cells, the majority of which represent those in which frequent ground target detection occur. Even with this reasonably extensive map the radar false alarm rate is significantly higher than the terminal MTD processors, principally due to moving ground vehicles on smaller roads too numerous to map.

2. MTD Performance

The MTD-II was operated at BVA for a period of approximately 18 months, starting in February 1979, and the goal of this development effort was to demonstrate that automatic digital radar target extraction could be achieved under all conditions. Performance comparisons were conducted against the operating primary radar channel which employed the CD target extractor. The ATCRBS beacon system was used as the basis of truth, for detection statistics during all tests, and performed at 95%-97% P_d throughout the testing period. The MTD-II was operated with essentially the same algorithms as were used during the BTV tests. Some parametric variations were introduced into Surveillance Processing to account for the 12 second vs 4.7 second scan rate and to handle military targets accelerating up to 3g. In addition, track initiation logic was modified to reduce the number of false tracks due to moving ground traffic which could not be censored.

For much of the testing period, the MTD-channel operated at reduced sensitivity with reference to the CD-channel due to the shortened pulse (increased bandwidth), and a failure to realize a compensating channel noise figure improvement. The channels were normalized, during September 1980, when the MTD channel noise figure was lowered (low noise pre-amplifier) to compensate for the bandwidth difference (4 dB). Although much of the performance comparison was conducted with the MTD channel somewhat less sensitive (-4 dB), (the MTD performed well despite this problem) the discussion of performance will be limited to the testing period when the channels were matched in sensitivity.

At ranges less than 100 nmi, where the CD-channel uses MTI processing to cope with ground clutter, the MTD consistently performed "better", in that it more nearly matched the beacon system in P_d , P_{FA} , and azimuth estimate variance. The CD-channel consistently operated at lower detection rates and at higher false alarm rates. At the time of the experiments the traffic within coverage of BVA were transponder-equipped. At ranges greater than 100 nmi, the CD-channel operated in "normal" mode, and performed essentially as well as the MTD in the absence of weather. No important angel activity was observed throughout the testing period at BVA. The CD false alarm rate was excessive in the presence of weather (hundreds of false target reports per scan). The

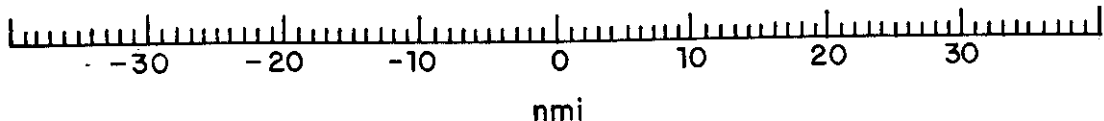
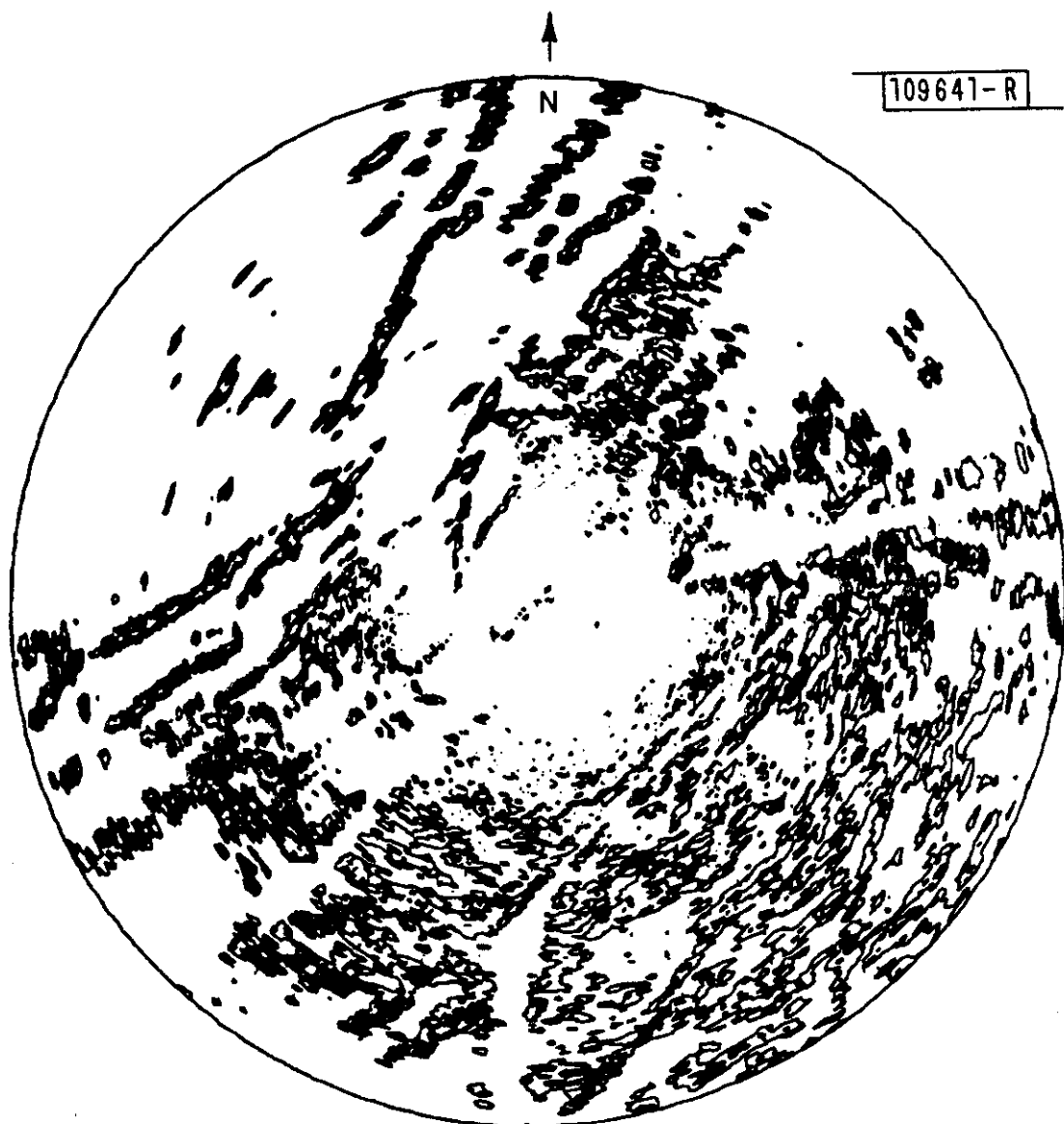

Fig. III-16. Clutter map - BVA.

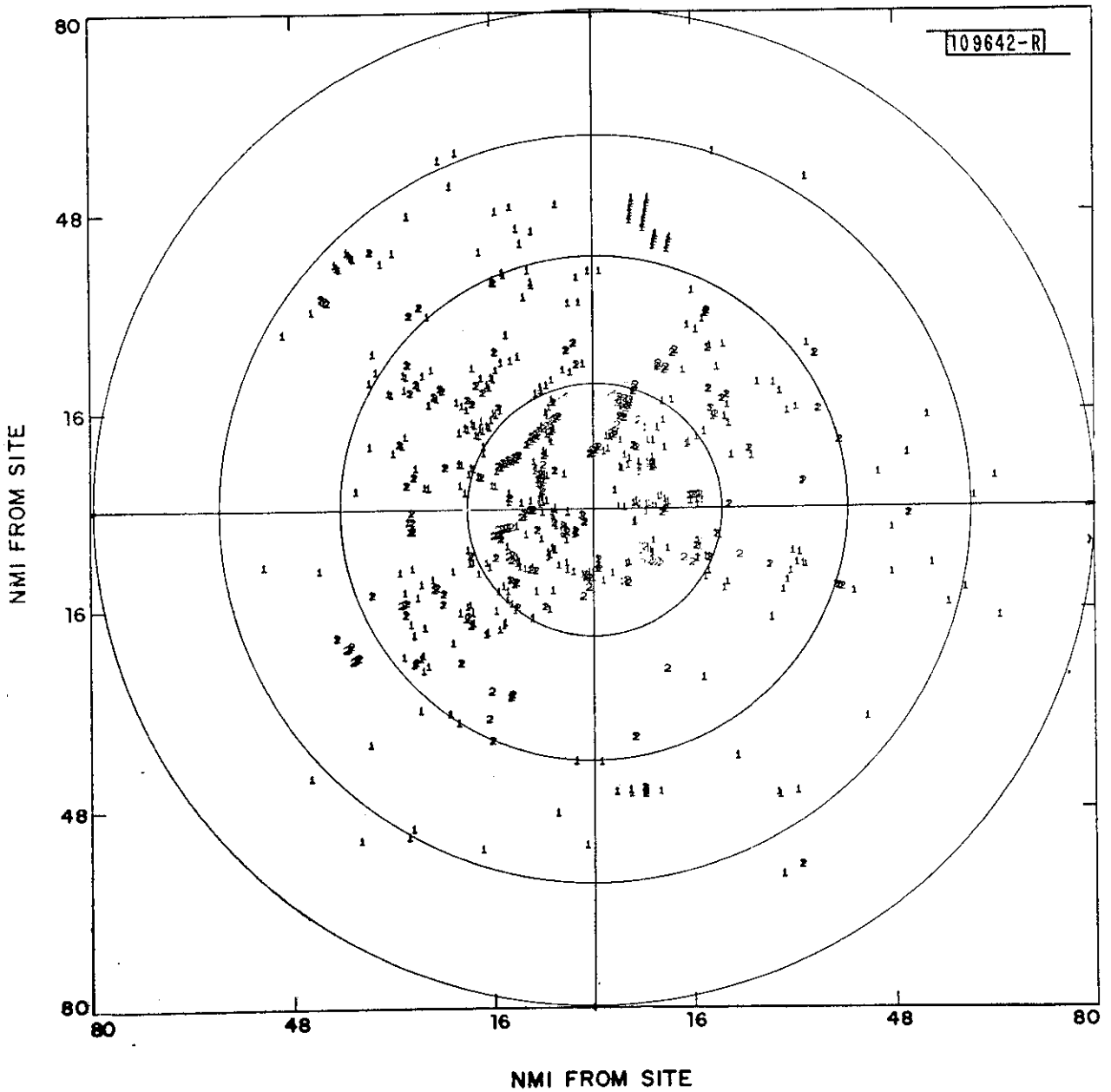

Fig. III-17. Fixed threshold map for Bedford, MA.

scan). The MTD performed as expected in the presence of ground clutter, and tracked tangential traffic using the ground clutter map CFAR thresholding algorithm.

The MTD tracker output for a flight test A/C is shown in Fig. III-18. Fig. III-19 shows 20 scans of data for the MTD and CD, for ranges out to 100 nmi. The CD false alarm rate is high, and although there was a 4-6 dB CD sensitivity advantage at this time, the P_d for both systems were about the same (0.94). Fig. III-20 shows target reports during a 37 scan interval for MTD, CD, and beacon. The systems perform at about the same level, but the CD operates with a greater false alarm rate.

3. Overview of MTD-II

Some MTD/CD comparisons were performed by personnel of the FAATC and will be reported separately. Although the MTD-II processing system was installed at BVA for approximately two years there were only two relatively brief periods during September 1979, and then again during September 1980, when careful performance comparisons were effected. Flight tests were conducted during these periods to determine relative MTD/CD/Beacon performance and the results of the September 1979 tests will be discussed.

Stationary ground clutter at BVA was not a problem for the MTD-II system, in that the front-end STC was able to control the clutter to a level within the dynamic range of the 10 bit A/D converters. The antenna system at Bedford is tilted at approximately 2-1/2° elevation to minimize some of the ground clutter effect for the CD. In September, 1979, the antenna system was tilted down to approximately 1.5° and this of course increased the clutter level for the primary and MTD channels. The MTD STC was still able to support, with the antenna tilted down, and it is in this condition that a series of flights were conducted at altitudes ranging from 4 kft to 13 kft, to discover whether low altitude coverage could be affected from this hilltop site. These tests were conducted during the early morning hours, approximately 0100-0500 (the time at which we were able to get a sensor shutdown) and of course during these hours the moving ground traffic problem was at a minimum, and our false alarm due to this cause were relatively slight. For all of the flight paths of the tests conducted in September 1979 the MTD performed at about 0.94 P_d , and with the low moving ground traffic false-alarm rate, the net output false-alarm rate was comparable to the BTV experience for the terminal sensor system.

The common digitizer was not examined carefully during these tests because of the excess ground clutter with the antenna tilted down. However, the beacon supported during these tests and in Fig. III-21a and b there is an example of the target reports provided by the ATRCBS beacon and by the MTD-II tracker output.

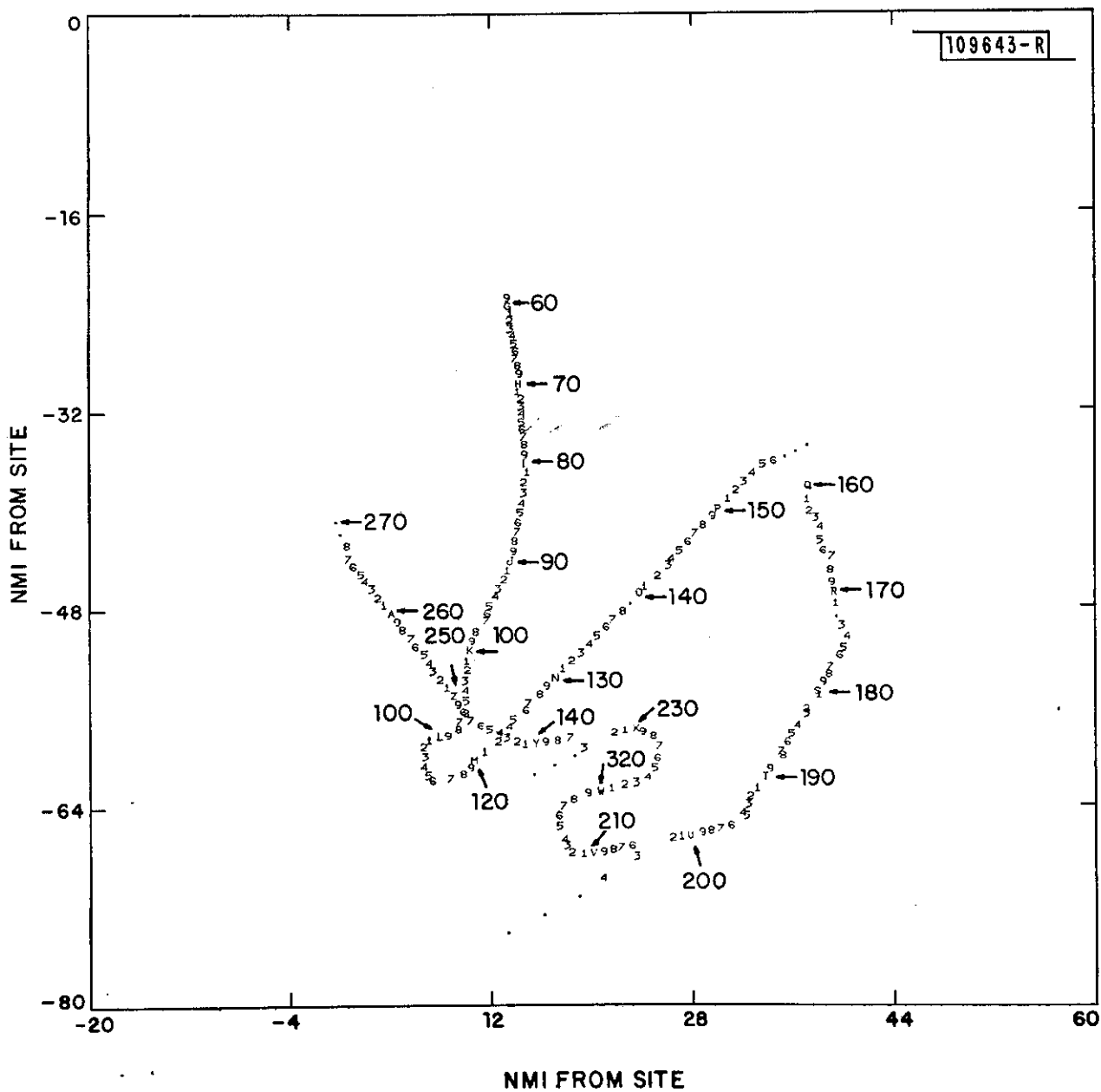
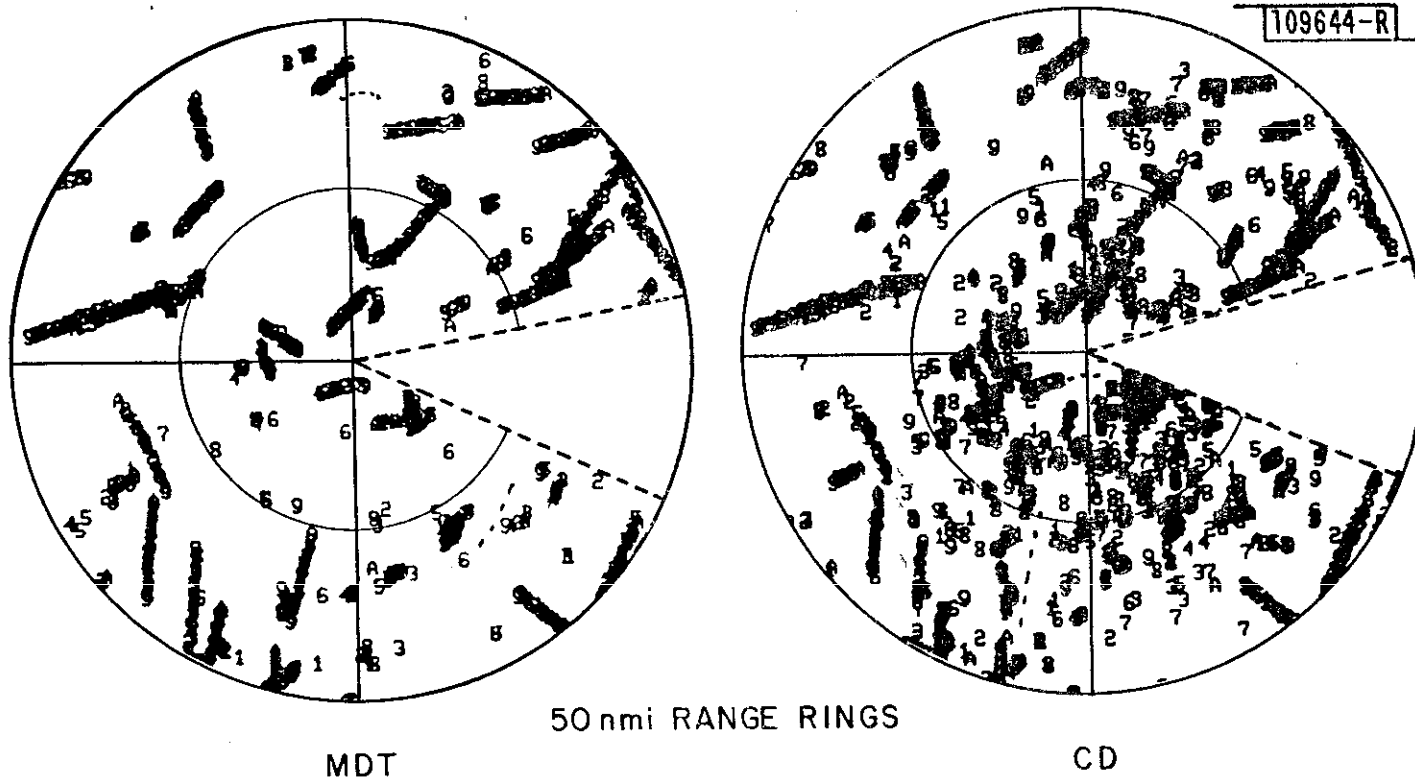
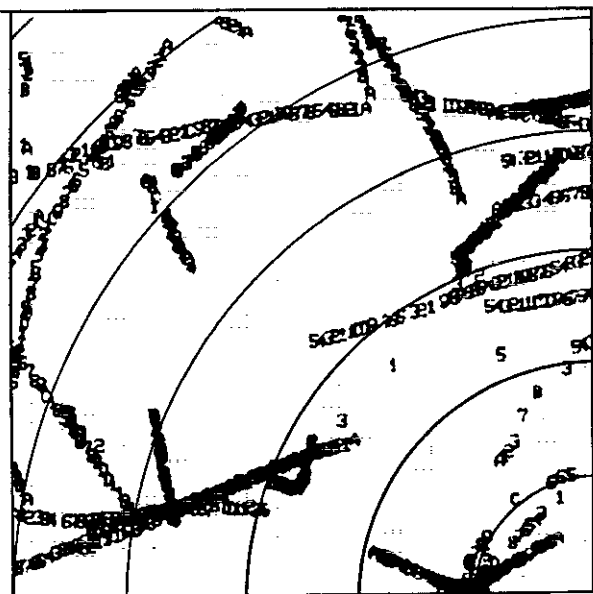

Fig. III-18. MTD target report, Gulfstream flight.



SECTOR BLANKED TO AVOID IRRADIATING PERSONNEL
ON ADJACENT ARSR-3 TOWER.

Fig. III-19. Radar target reports; MTD vs CD.



MDT

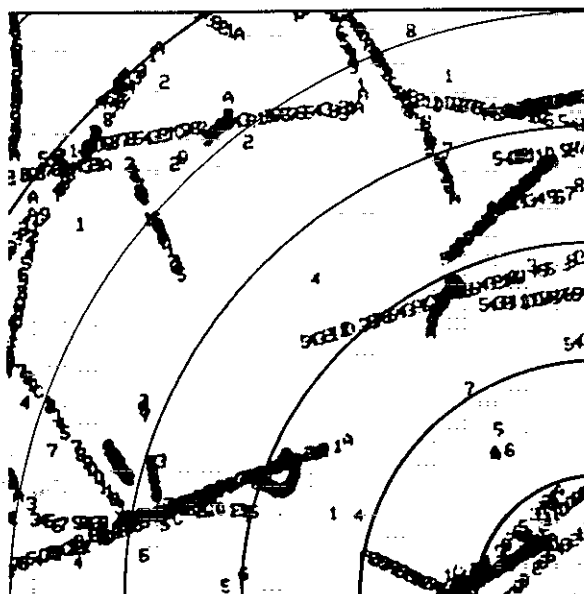

BEACON

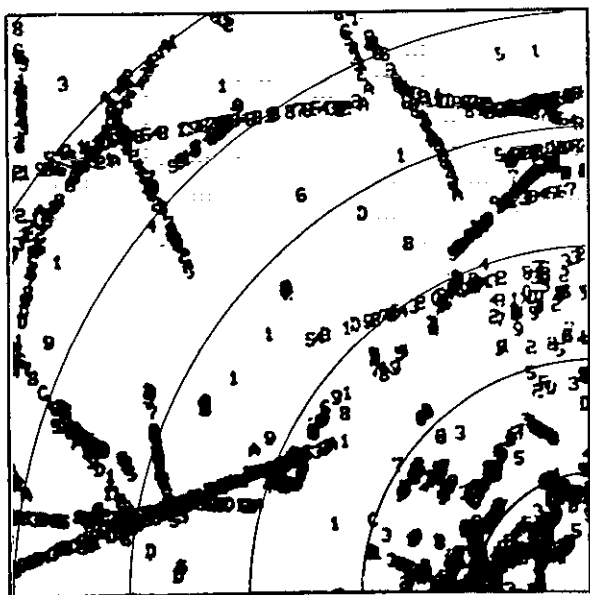

CD

TARGET REPORTS
 RADAR AND BEACON
 37 SCANS
 20 nmi RANGE RINGS

109645-R

Fig. III-20. Target reports using target extractor at Bedford, VA
 MTD vs CD vs beacon.

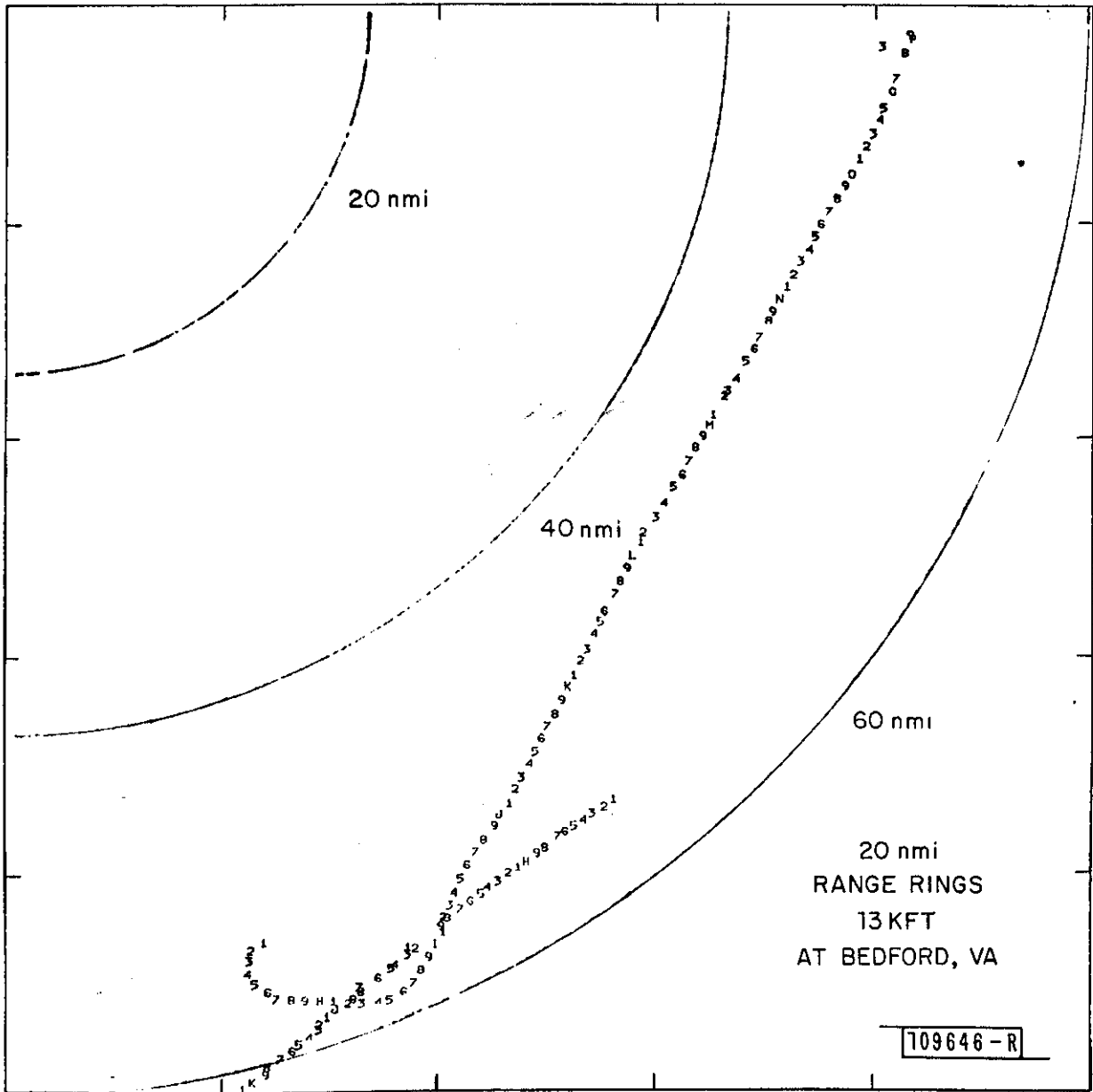

Fig. III-21a. Beacon reports on Gulfstream aircraft (4-Altitude Flights).

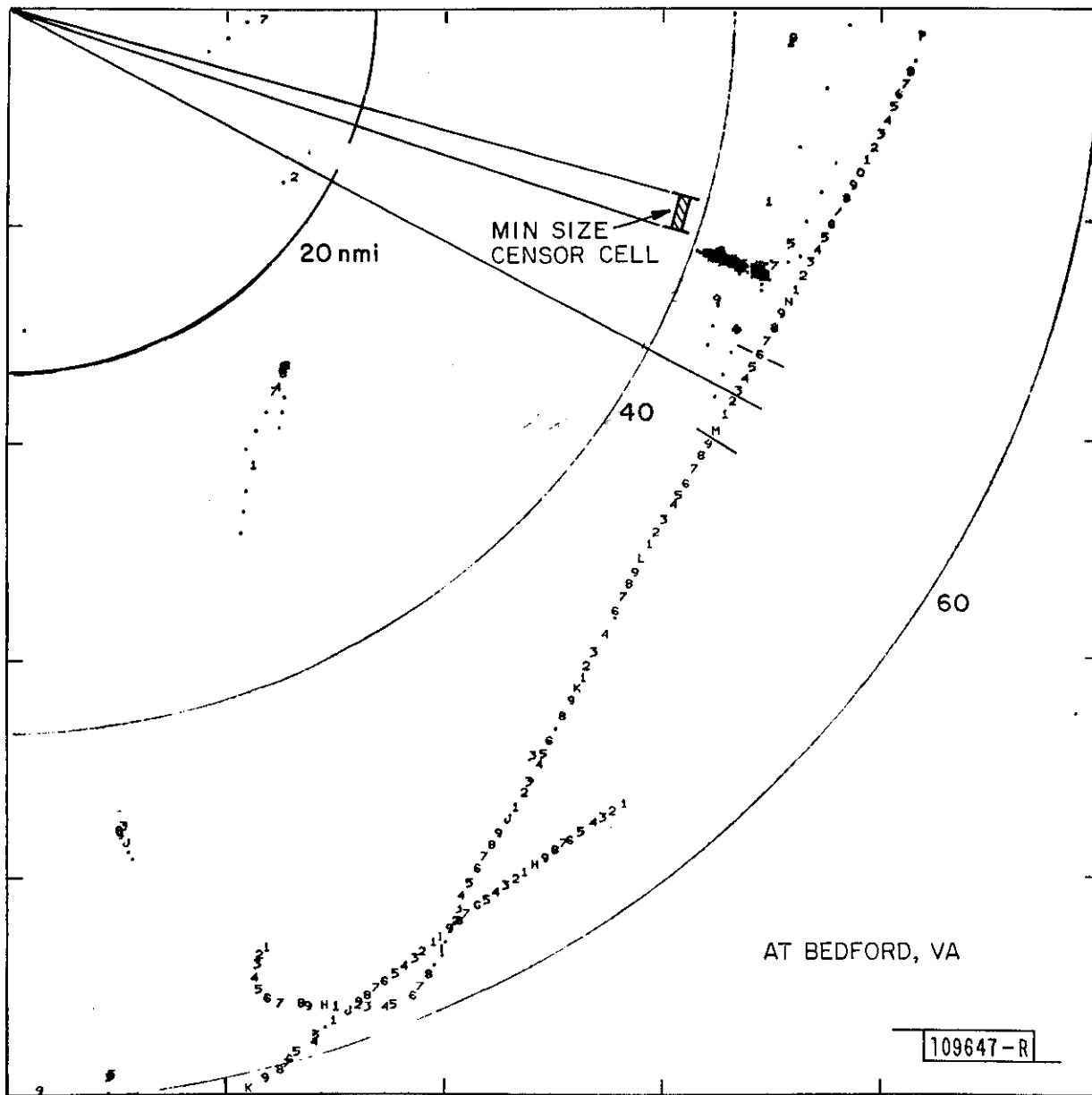

Fig. III-21b. Radar reports on Gulfstream aircraft (4-Altitude Flights).

The data shown is for a 90-scan interval (18 minutes), and includes one A/C target-of-opportunity. The beacon reported 90 of 90 for the test A/C and 40 of 41 possible reports for the target-of-opportunity. The MTD-II reported 85 of 90 for the test A/C, and 39 of 40 for the other. Since both channels were operating asynchronously, during the tests, a cross-channel blanker was used, to blank the MTD processor during CD-channel transmissions. A 12 μ sec gate was used, thus blanking 8 each, 8-pulse CPIs for each CD pulse. Thus 5% of the MTD processing interval was saturation-blanked. However, since fewer than 40% of centroided MTD target reports are single CPI, only 2% of all reports are lost. Thus 2-3 of the above missing MTD target reports may be attributable to this effect, and the resulting blip/scan ratio may be as high as 0.98, not atypical for targets at this range. The false-alarm count (moving ground traffic) was approximately 50, or fewer than one per scan in this coverage. During mid-day the false alarm count might be ten times as high (5-6 per scan in this sector of coverage). Tilting the antenna down improved sensitivity on the horizon (approximately 4 dB two-way), and improved coverage of low altitude traffic close to the sensor. Moving ground traffic false alarms, however, were somewhat increased. The test A/C was moving tangentially with respect to the radar, at a ground speed of 240 mph, during scans 130-136 (M_0-M_6) at which time the radial velocity was less than ± 14 mph. Detection was likely to have resulted from zero-velocity filter declarations, over 30 dB C/N_0 ground clutter, indicating a scattering cross-section in excess of $+10$ dBSM, seen broadside. The CD, operating in the MTI-mode at this range, would probably have missed some of these reports. The CD data for this flight (antenna tilt), was not examined, thus this could not be confirmed. The test A/C flew this trajectory at 4K, 7K, 10K, and 13K feet, all with essentially the same results. The elevation angles varied from 0 to 1.5 degrees for this geometry.

Little experience was gained with weather and angel activity at BVA, during the periods of formal data collection. However, false-alarms from "small" weather cells, was experienced on a number of occasions. The linear CFAR weather thresholds were operated using 16 range gates (the same as terminal ASR/MTD), but since these were 1/8 nmi gates the thresholded interval was 2 nmi, apparently too large statistically for the "small" instability shower cells encountered. Under conditions of widespread instability showers (summer conditions) it will likely be necessary to operate with an eight-gate CFAR, and absorb an additional 2 dB thresholding loss, to control the false alarm rate. If, however, automated, contoured weather data were available, then these false alarms, which track the weather cells, could be "handled" by ATC controllers without censoring. On occasion, anomalous propagation (ducting) was experienced at BVA. The greater Washington, D.C. area at a range of approximately 145 nmi, would create an excessive number of zero-velocity filter false alarms. A modification to the C&I fine-grain adaptive thresholding algorithm (not tested at BVA), allowing for density CFAR of the zero-velocity filter should eliminate these false alarms.

Whereas in the terminal environment (BTV, FAATC) the MTD-II supported automated target extraction comparable to the ATCRBS/DABS beacon systems, and handled the traffic that was not transponder equipped, this was not the case in the enroute environment. The enroute beacon system performs well because of siting; no blockage, reflecting obstacles, diffracting obstacles, or ground reflection multipath, while the radar processor improvements increases the probability of detecting slow-moving ground traffic in ground clutter.

The surveillance processor logic used at BVA was essentially the same as that used for BTV and was not optimized for the enroute problems (12-second update rate, and moving ground traffic false alarms). More development effort is required in the areas of track initiation, target-to-track association, and track smoothing, to reduce the number of slow-moving ground traffic false alarms, and to support improved track identity continuity. The surveillance processor, as implemented, served as a filter to reduce the output false alarm rate, and used a simple A/C tracking function for this purpose, but did not attempt to "force" correct association for considerations of maintaining target identification. Still, the system does perform the automated target function, and will permit operation of the enroute antenna at a lower tilt angle, thus improving both long range and lower altitude coverage. The CD target extractor at BVA, operating without benefit of a surveillance processor, and some adaptive signal processing features, generally operated at a high false alarm rate (20-100 per scan). Detection performance was good where "normal" rather than "MTI" mode was used. Performance in rain, and against tangential traffic was generally poor, with considerably increased false-alarm rates in rain. Thus, the primary long range L-Band radar system can be improved, using MTD processing, and could support the secondary beacon system, albeit, without code or altitude data.

IV. MISCELLANEOUS SYSTEM ISSUES

The Burlington, VT ASR-7 radar site represents a very difficult ground clutter environment, and provided unexpected difficulties for automated processing. Although the antenna is tilted up to 2.5° referred to the horizontal plane (to reduce the effects of ground clutter), the hills and ridges to the east and southeast subtend a 2.5° angle to the site, and are, therefore, illuminated at the peak of the antenna elevation pattern. Radar reflectivity was high (0-10 dB₀) and the range (10-17 nmi) was beyond normal STC desensitization. It had been anticipated, based on earlier MTD operating experience, that a "few handfulls" of stationary singularities would exceed the system dynamic range, and would be censored by saturation testing. Approximately .005% to .01% of the range/CPI coverage might be blanked as a result, and this was considered acceptable for terminal coverage. At BTV, using an R^4 STC starting at 13 nmi, there were approximately 4000 range/CPI cells which exceeded the dynamic range of the radar system (nearly 1% of cells), and censoring was considered to be unacceptable. The effects on automated system performance, and the solutions implemented in MTD-II processing will be discussed in this section.

A. FIR-Filters and Ground Clutter

Detailed discussions of optimal processing in the presence of ground and weather clutter are presented in Refs. 1, 2 and 3, and will not be dealt with in this section. As a practical consideration, statistical clutter distributions and scan-to-scan temporal variation might require that 5×10^5 optimal filter banks be developed for each antenna scan, and such a real-time processing workload thus generated would be beyond today's art. The surveillance radar systems to be automated are in operation within the ATC system, and generally have unalterable coverage, scan rate, antenna beamwidth, and power/aperture product.

These features place limitations on the processors which can be used, since PRF is controlled by range coverage requirements, the number of pulses per beamwidth is controlled by the beamwidth, scan rate, and PRF, etc. The processor selected for use with both terminal and en route radar systems was based on 8-pulse CPIs, dual staggered PRF, and approximately two CPIs per azimuth beamwidth (two-way). A candidate model for ground and weather clutter was postulated (+40 dB Ground Clutter/Noise, and uniform weather clutter at all velocities, except for a window about the velocity of interest), and the optimum processor computed for this model. Eight each eight-point FIR filters were developed to "nearly" match the performance of the optimum processor, in velocity space. Fewer than eight pulses would sacrifice integration gain, and more than eight would provide redundant coverage in velocity space at increased processing load. The filter bank, as described in Section II, is nearly optimum for the clutter model described above. It is not optimum for clutter/noise below or above +40 dB.

1. Cumulative Distribution Function of C_i/N_o

The cumulative distribution function C_i/N_o for the BTV site is shown in Fig. IV-1, and shows that there is a 70 dB dynamic range. Those cells with C_i/N_o less than +40 dB (98% or more) are affected by "gaps" in velocity space near zero-velocity, which might be covered by modified 1 and 7 filters. The penalty here is small, statistically, since most of the range/CPI cells (80%) have no clutter, and detection using the zero velocity clutter map cover the velocity space near zero. Those cells with C_i/N_o greater than +40 dB (2.0%) affect the system by producing false alarms, due to clutter scanning modulation residue in the non-zero velocity filters. This problem has to be dealt with in an automated processing system, since excess moving target false alarms subjectively distract air traffic controllers more than a slight reduction in real target detection probability. For this reason, adaptive and deterministic (site-dependent) algorithmic modifications were implemented, to limit the rate of ground clutter-induced false-alarms per scan to fewer than one, even though 10^4 range/CPI cells are candidates for false primitive target declarations.

The techniques for adaptive (cell-by-cell velocity-dependent) desensitization, and fixed-map dependent desensitization/censoring were described in Section II, above, and will be discussed in more detail later in this section.

2. Radar System Instability

System gain, phase, and timing instabilities which contribute to AC residue, after cancellation, become increasingly important as higher MTI improvement factors are sought. Whereas +30 dB (DC/AC) instability residue systems have been adequate for limiting multi-pulse clutter cancelling processors until recently, the MTD-II processor requires +49 dB (DC/AC) instability residue to prevent high amplitude ground clutter returns (+51 dB C_i/N_o) from causing false primitive target declarations in the finite velocity filters. Even at this level, noise-plus-clutter instability residue is increased by approximately +4 dB referred to front-end system noise alone, and increases the false alarm rate per filter to 10^{-3} from 10^{-5} set by CFAR thresholding. Considering the BTV ground clutter statistics shown in Fig. IV-1, a large number of cells are affected by radar system instabilities (4000 range/CPI cells, and seven filters each). The BTV magnetron radar system provided a level of +42 dB (DC/AC), and required adaptive desensitization to control the rate of false-alarms (at +51 dB C_i/N_o the residue/ N_o was +9 dB for filters 1-7). This feature limits the SCV performance even at midband (PRF/2). The magnetron radar system at FAATC provided +47 dB (DC/AC) instability residue, and carefully designed klystron systems achieve in excess of +50 dB at S-band.

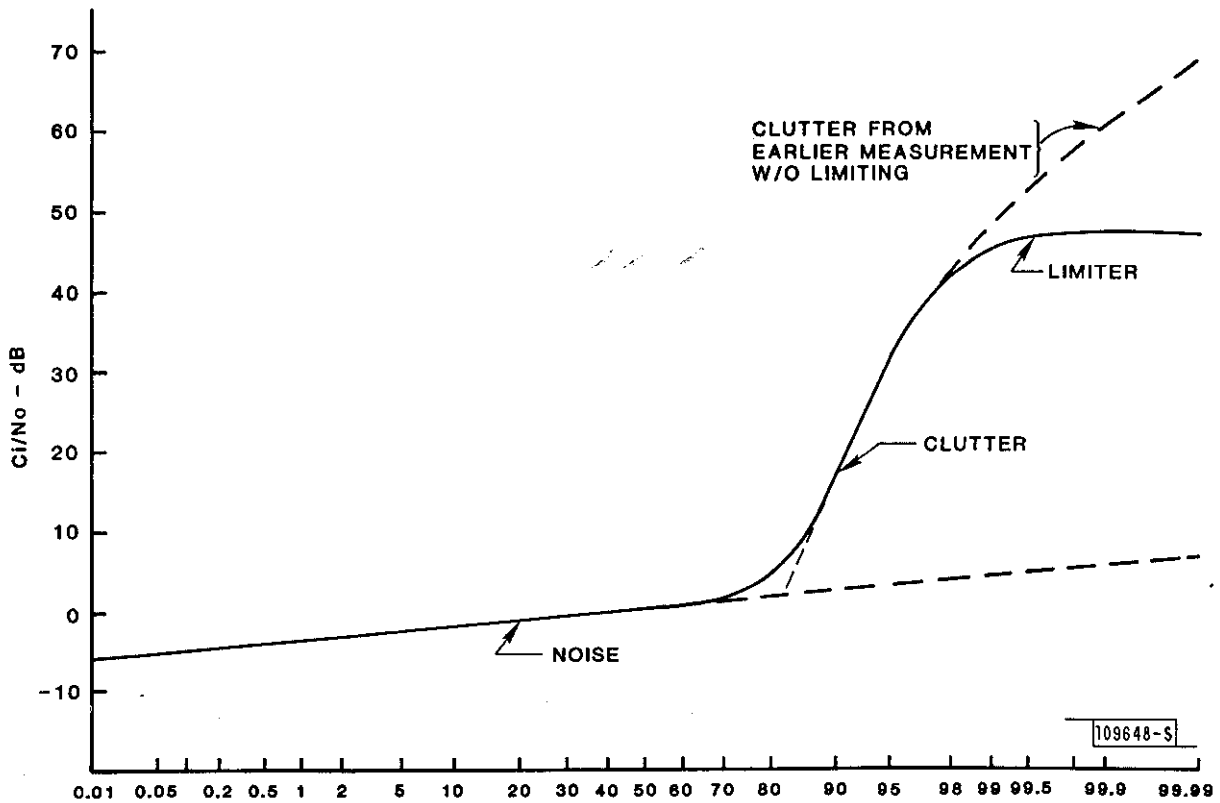

Fig. IV-1. BTV clutter, cumulative probability distribution.

Although the single frequency, narrow-band AN/FPS-67 klystron system, operating at L-band could achieve in excess of +60 dB, only minor modifications were added to the BVA system, and the system supported at +42 dB to +45 dB (DC/AC) instability ratio during field testing. Since high amplitude, overloading ground clutter, was not an important feature at BVA, this level of instability residue was tolerable.

When operating without limiting the MTD-II had an instantaneous dynamic range of 51 dB, and +7.7 dB of coherent integration gain (+9 dB nominally, reduced by 1.3 dB of weighting mismatch loss to control filter velocity side lobes). Neglecting other losses, the minimum required IF S/N required to support P_d of 0.5, and P_{fa} of 10^{-5} is +4.3 dB. This signal would be detectable in the presence of a ground clutter signal of +51 dB S/N in the absence of system instabilities. The system SCV under these conditions would be 46.7 dB, without considering effects of clutter scanning modulation residue, at this point. For the case of system instability residue of +42 dB, the residue/ N_o level would be +9 dB, ($C_i/N_o = +51$ dB) and the CFAR threshold raised by 9 dB thus reducing system SCV to 37.7 dB. Somewhat less severe desensitization might be employed at the expense of increased clutter false-alarm rate. However, it is clear that if system SCV values in excess of 40 dB are to be achieved, more care will be required in designing the radar system for instability residue ratios in excess of 50 dB.

3. Limiting

The cumulative probability distribution function of the BTV ground clutter C_i/N_o is shown in Fig. IV-1. Amplitude limiting was employed to keep all of the range-CPI cells within the dynamic range of the signal processor (limited to +51 dB C_i/N_o by the 10-bit A/D converters). A functional block diagram of the IF video processor is shown in Fig. IV-2, describing the implementation of limiting, ahead of the I/Q-A/D converters. The gain-transfer fraction of the limiting IF section is shown in Fig. IV-3. For zero-velocity ground clutter signals within the linear range of the system, scanning modulation residue is introduced into the finite velocity filters due to amplitude modulation of the pulses in the 8-pulse CPI, resulting from the two-way antenna pattern, as a stationary target. The residue/noise for filters 1 and 7 is shown in Fig. IV-4 for a +51 dB C_i/N_o ground clutter singularity. The zero-velocity filter response is shown with +9 dB (8-pulse) integration gain, although the filter actually implemented has only +5 dB gain. The residue to noise (filters 1 and 7) reaches a peak at boresight of +11 dB, and would cause primitive target false alarms at a rate near unity per scan. Filters 1 and 7 are designed to be optimum for $C_i/N_o = +40$ dB, and the residue/noise for this case would be 0 dB; desensitization against ground clutter residue would not be required, since the weather CFAR threshold is set to ≈ 14 dB. Residue/noise for filters 2/6, 3/5, and 4 is lower than that shown for 1/7, and is less of a problem. The residue/noise for filters

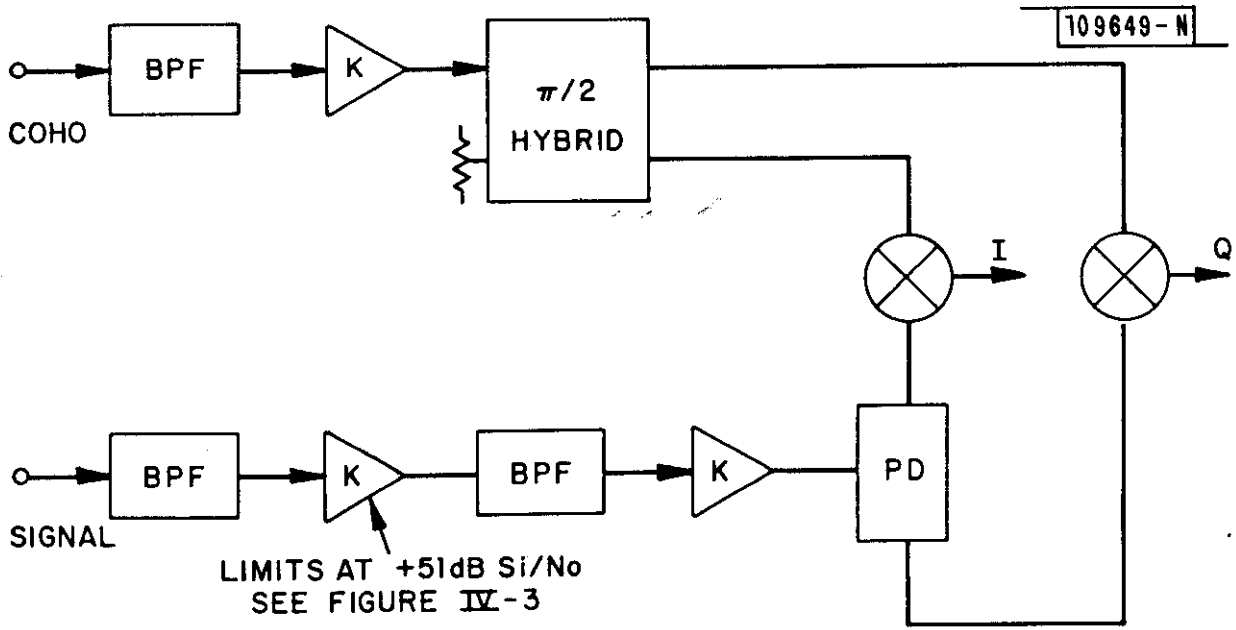

Fig. IV-2. IF-video processor.

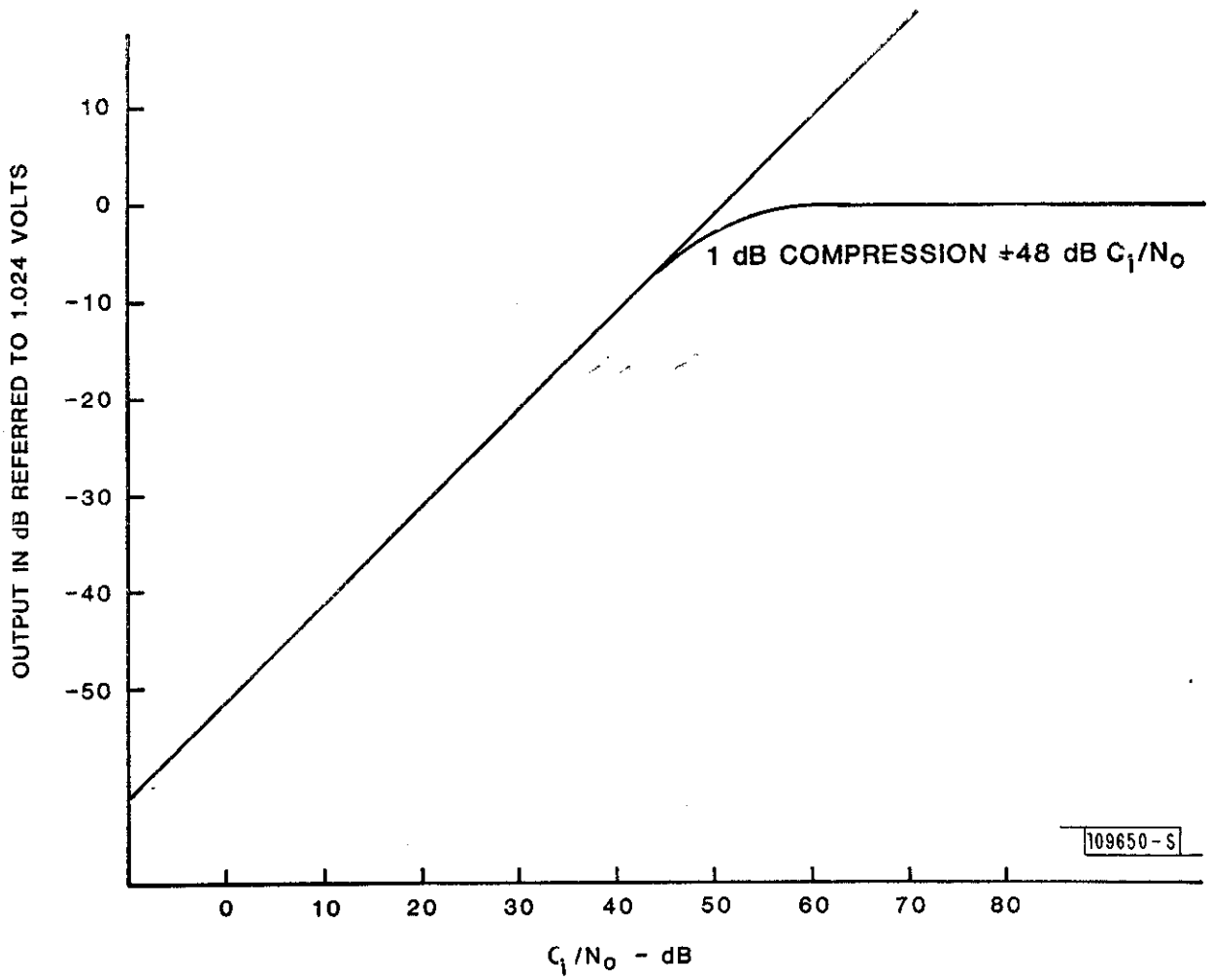

Fig. IV-3. Limiting IF transfer function.

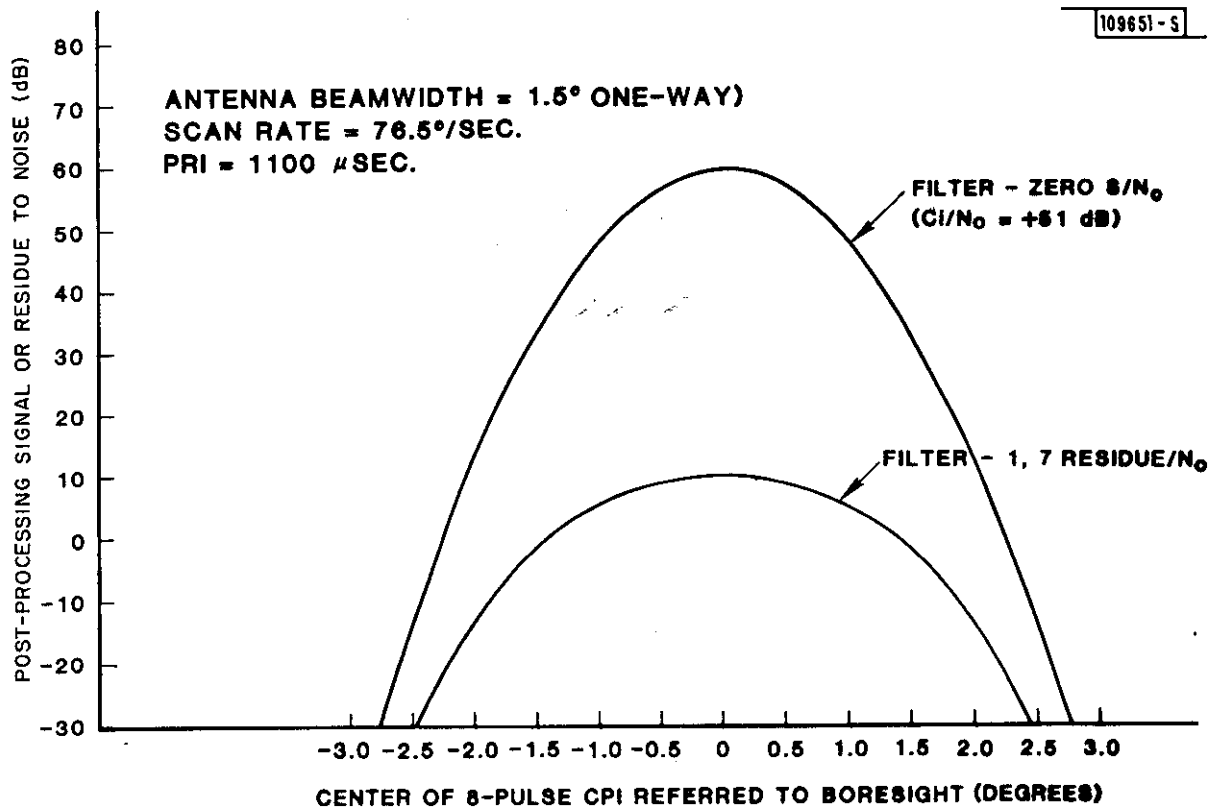

Fig. IV-4. Ground clutter scanning modulation residue (linear).

1 and 7 under conditions of overloading clutter (+71 dB C_1/N_0) and 20 dB of peak limiting is shown in Fig. IV-5. The residue/noise reaches peaks of +21 dB on either side of boresight for linear processing. An example showing the pulse amplitudes for an 8-pulse CPI is presented in Fig. IV-6. The two-way antenna voltage pattern used for all examples is:

$$A = A_0 \epsilon^{-\theta^2/3.24},$$

θ is in degrees

Antenna scan rate = 76.5°/sec, and

PRI = 1100 μ sec.

The normalized (one-sided) velocity response of stationary ground clutter is shown in Fig. IV-7 with the response of filter 1, near zero-velocity, having its peak at 11.3 m/sec. (At the alternate PRF, this filter response peaks at 13.8 m/sec). In order to reduce the value of primitive target declarations in regions of high clutter/noise (greater than +40 dB C_1/N_0) due to scanning modulation residue, a fraction of the normalized zero-velocity magnitude was added to the mean-level-threshold (MLT) value for each non-zero filter in the range-CPI cell being processed:

$$MLT'_{fi} = MLT_{fi} + \frac{A_0}{\alpha_i}$$

A_0 = 0 velocity filter magnitude

α_i = Filter dependent desensitization constant

This is only an approximation to the actual value required to maintain a constant clutter false alarm rate, but was used to reduce the rate of primitive target declarations being handled on the multi-processor interface bus between computers.

4. Fixed-Threshold Map

A static threshold map is used to further control the false alarm rate in the C&I processing stage. A map was developed for BTV using two levels of desensitization for two filter groups (1, 2, 6, 7 and 3, 4, 5) with granularity of 1/4 nmi by 2 CPIs. In the absence of severe weather clutter, the system operated at output false-alarm rate of fewer than 0.3 per 4.7 second scan while supporting aircraft $P_d \geq$ than 0.94, for targets-of-opportunity and flight-test aircraft.

5. Clutter Residue Mapping Processor

The two-stage process of reducing false alarms due to high amplitude ground clutter, described above, represents a non-optimum solution, since only a few desensitization levels were implemented, and these controlled by high

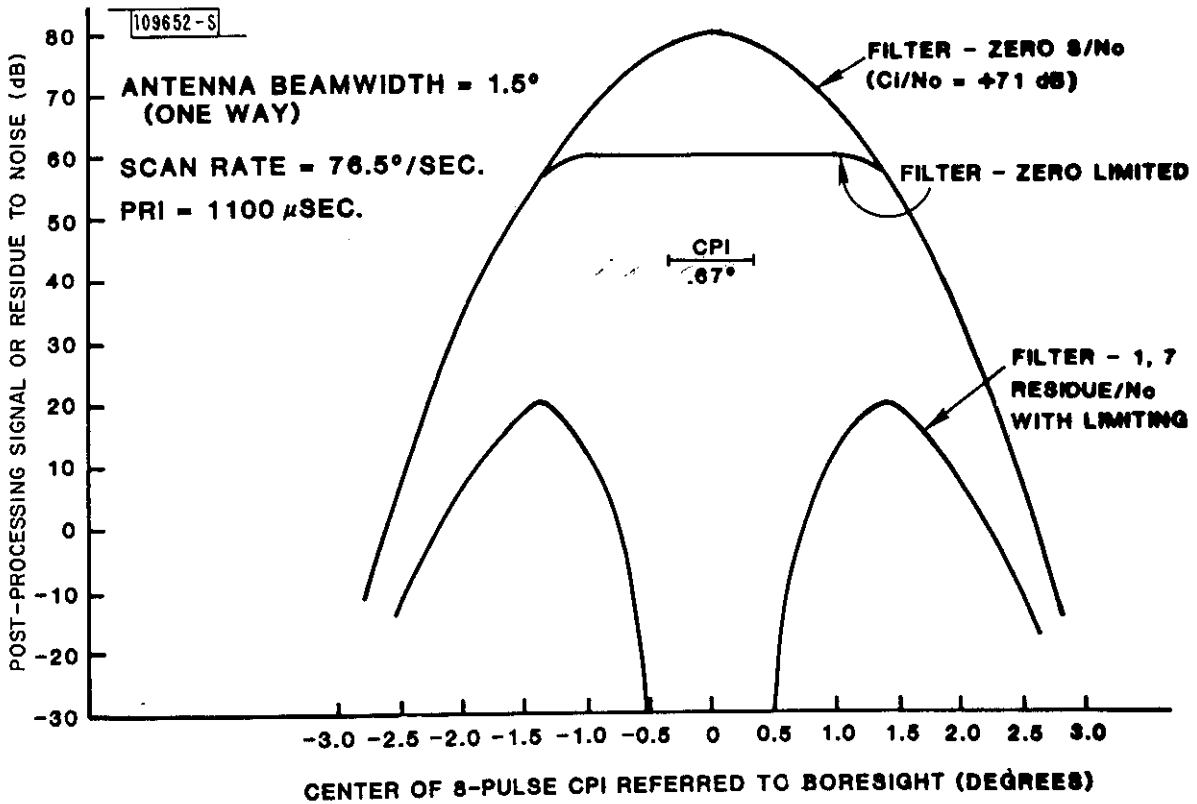

Fig. IV-5. Ground clutter scanning modulation residue (20 dB limiting).

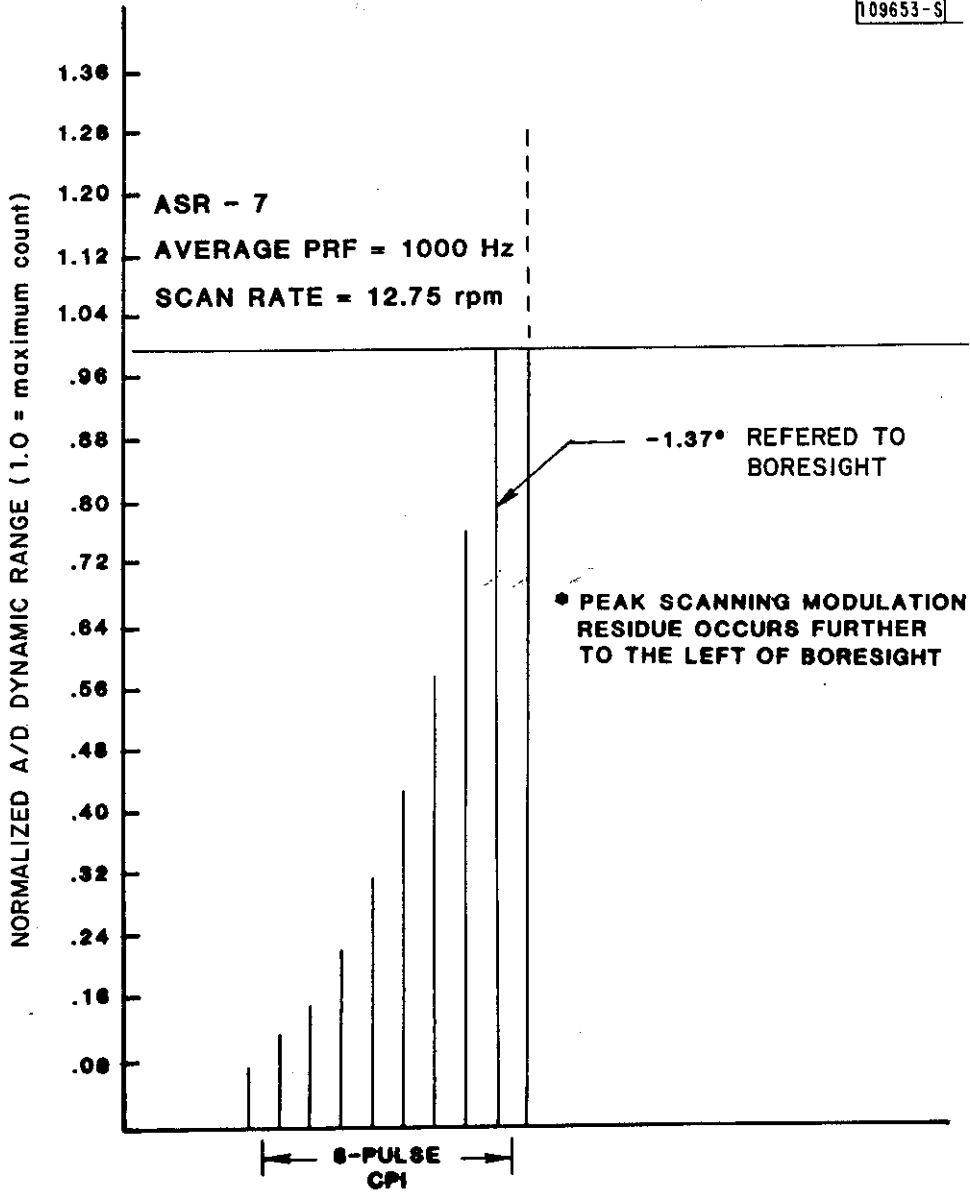

Fig. IV-6. Example of 20 dB hard limiting.

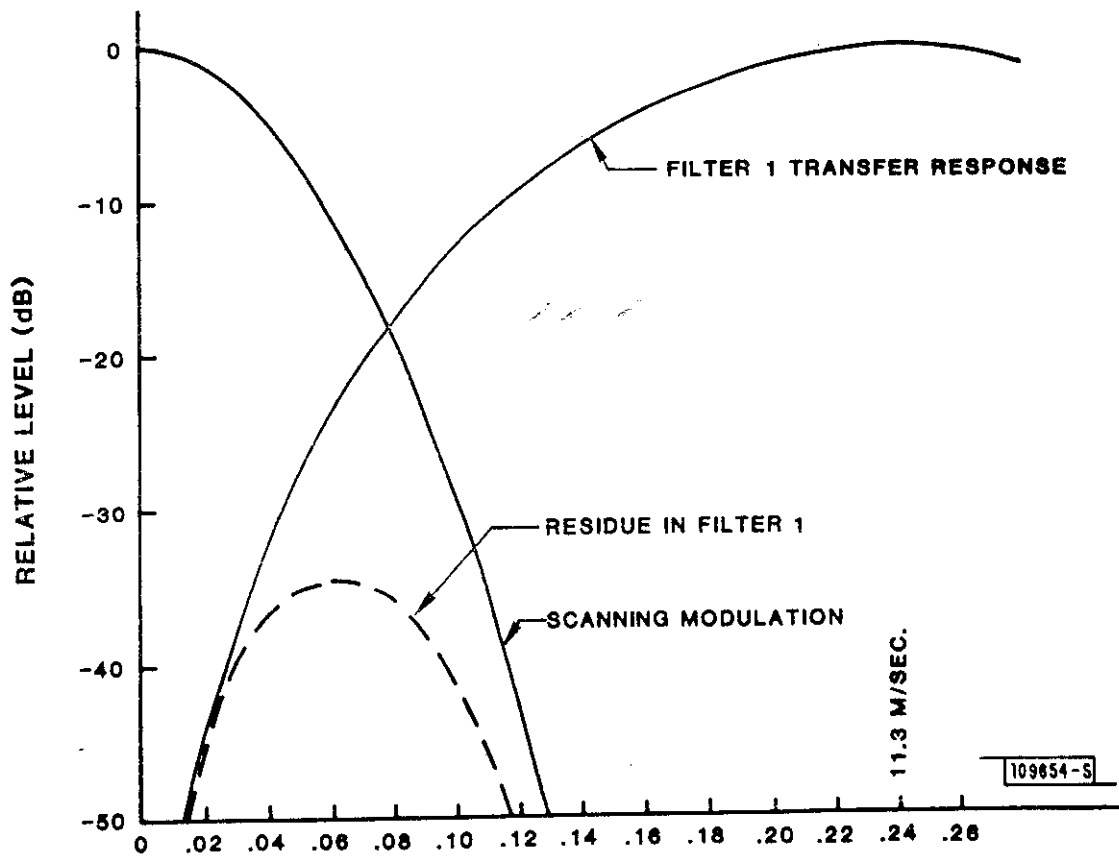

Fig. IV-7. Normalized frequency - fractional PRF.

of the temporally smoothed scanning modulation residue, in each range/CPI/filter cell. Due to a limitation of auxiliary memory space, only 10 nmi (160 ea. 1/16 nmi range cells) of coverage was implemented, using six processing modules, and the spare (seventh) was used for normal CFAR processing. Examples of comparative data are shown in Figs. IV-8 and Fig. IV-9. An expanded view of +30 dB C_i/N_o ground clutter contours is shown in Fig. IV-10, to indicate the cause of false-alarms in Figs. IV-8 and IV-9. Although there were intervals during which the residue-map processor outperformed the CFAR-RAG-MAP processor (same or better P_d , lower false-alarm rate) the average performance differences were negligible, as can be seen in the above examples. This was a surprising result, since the mechanism(s) which would cause the residue-map processor to produce a higher-than-expected false alarm rate were not then understood. A limited number of experiments were conducted to explore the nature of the problem and although explanations for failure of the residue-map processor were discovered, the underlying nature of this problem is still not well understood.

The antenna system was stopped (pointing at high-amplitude clutter) and a single range gate was sampled continuously (single-gate processing SGP). System instability residue was examined using a real-time 64-pt FFT processor and display system to monitor this single resolution cell without antenna scanning modulation effects. Isolated ground clutter singularities behaved as expected, in that long-term (10-20 minutes) C_i/N_o was constant to within a fraction of 1 dB, as observed at the output of the signal processor after filtering and magnitude functions. Cells which were part of distributed ground clutter regions behaved differently.

Fig. IV-11 shows a 70-second "event" which was typical of the output magnitude variations observed in filters 1 and 7 over a one-hour period. Since temporal smoothing of the residue map was on the order of 38 seconds (7/8 map + 1/8 new value each 4.7 seconds) the threshold value does not track, and about 8 scans operate at high P_{fa} . These features are distributed in range, because the linear CFAR thresholding technique is not subjected to the same false alarm mechanism. The 1/16 nmi cell being observed was at approximately 13.5 nmi range, and the peak S/N could be attributed to rain at +5 dBz or even a clear air refractive index gradient, moving at the mean velocity of the air (+25 mph for filters 1 and 2). This technique "worked" as expected on cool, clear, dry nights, but in general did not perform as well as the CFAR technique.

B. High-Angle Coverage with STC

The operating MTI-channel at BTV used an 8 nmi R^4 -STC which flattened at 20 μ sec (\approx 1.6 nmi), while the MTD channel used a 13.2 nmi R^4 -STC which flattened at the limit of attenuation (40 dB). Thus A/C at short range and

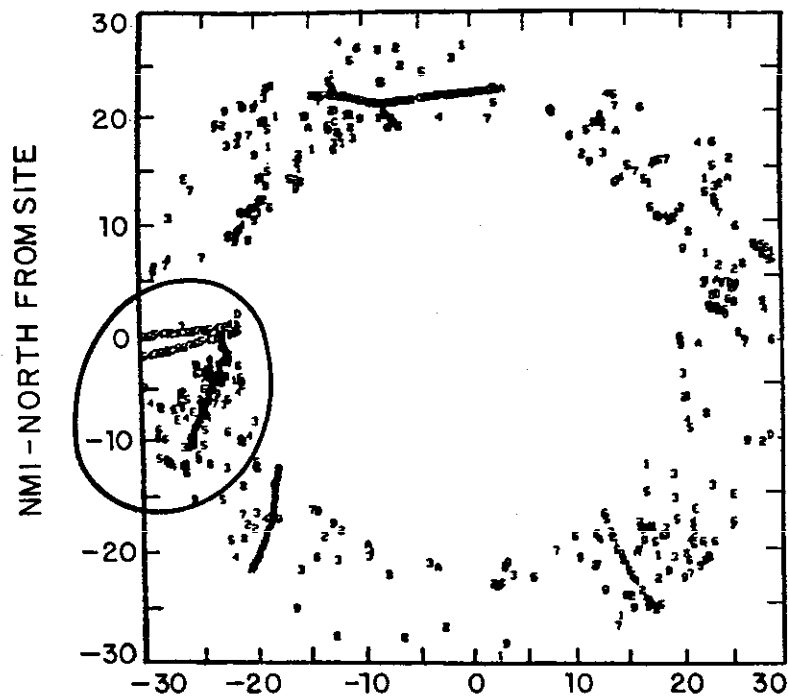

Fig. IV-8a. MTD target reports - residue map.

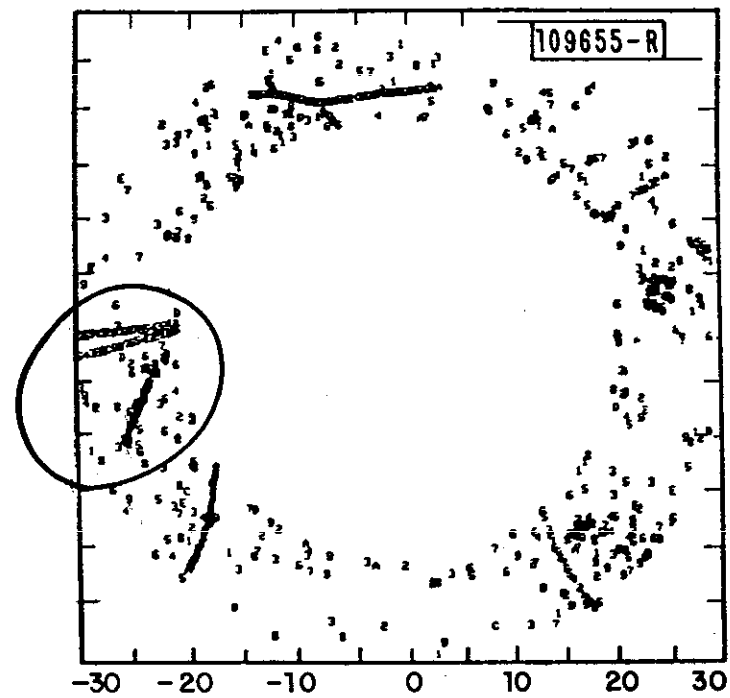

Fig. IV-8b. MTD target reports - linear CFAR.

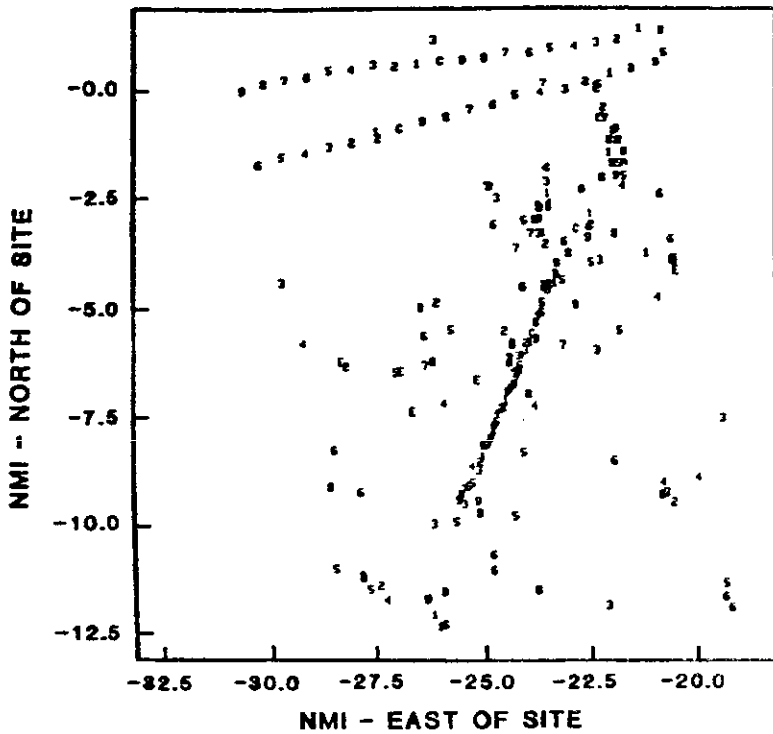

Fig. IV-9a. MTD target reports -
residue map.

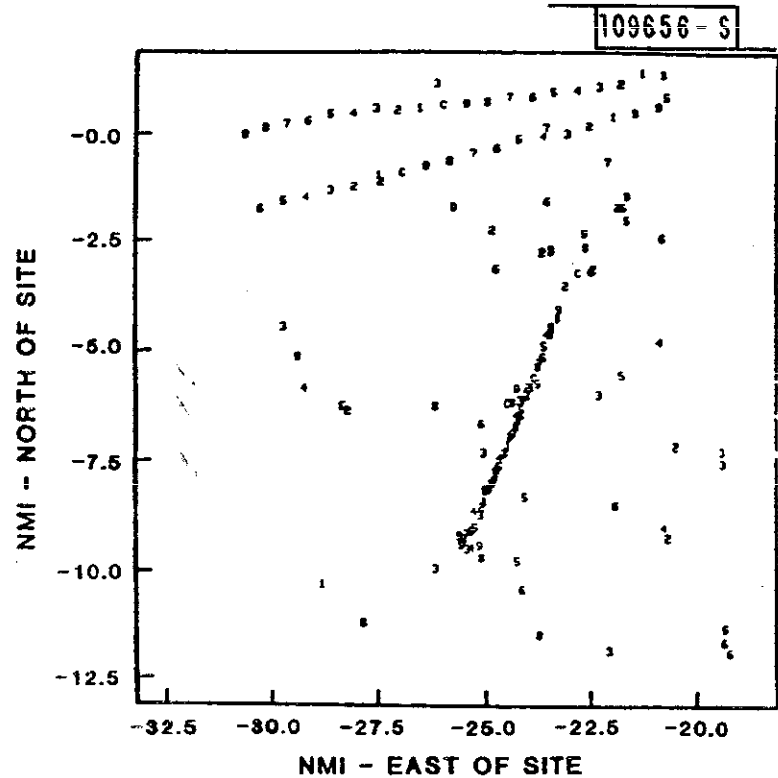

Fig. IV-9b. MTD target reports -
linear CFAR.

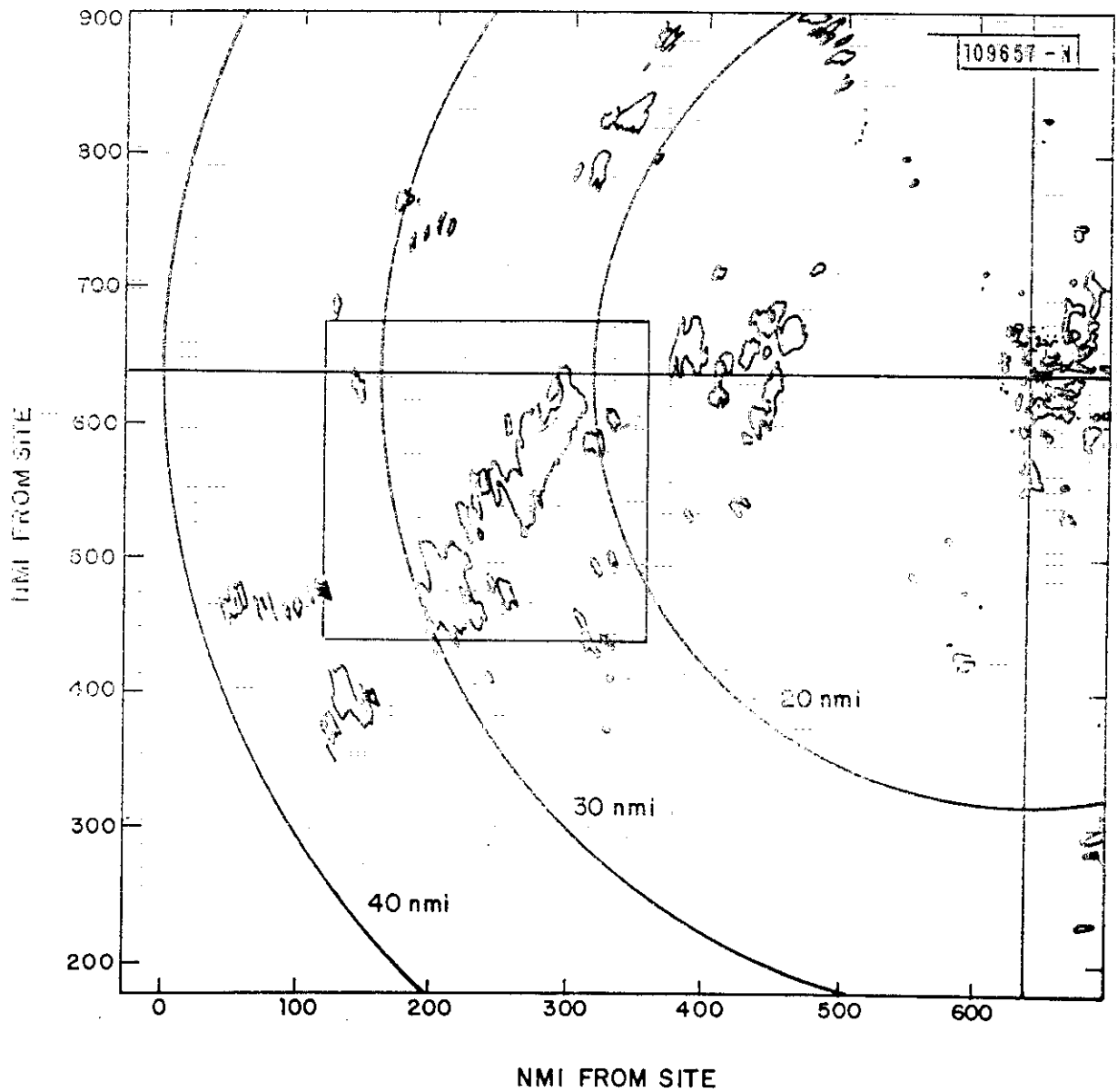

Fig. IV-10. 30 dB C_1/N_0 contours for area which includes regions of Figs. IV-8 and IV-9.

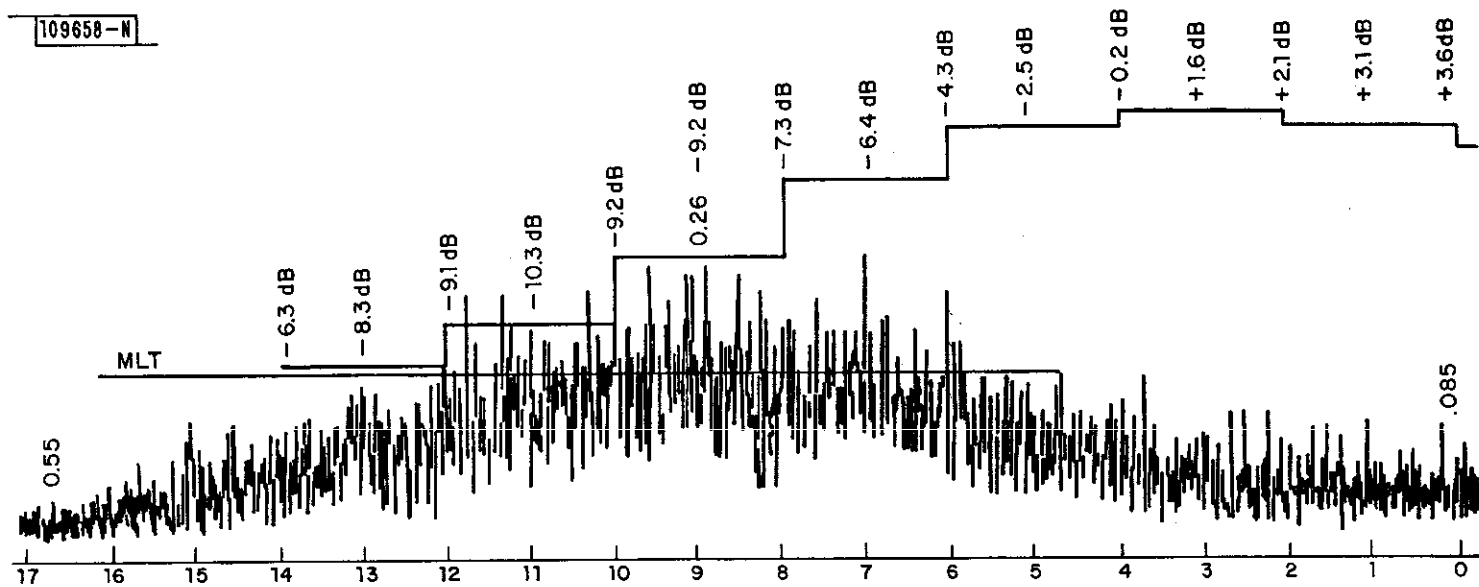

Fig. IV-11. Single 8-pulse CPI sample (8-scans, high P_{FA}).

high angle (over flights with test A/C) could be missed by the MTD channel and detected by the MTI channel. The MTD channel STC characteristic was required to prevent overloading the minicomputer C&I processor, and it was necessary to demonstrate that high-angle coverage would be achieved with newer antenna systems (ASR-8/9) at sites similar to BTV. The ASR-7 antenna was tilted up to 4.7°, to simulate the passive hornfeed of the ASR-8 antenna, as shown in Fig. IV-12. Test flights were conducted, and it was demonstrated that both the MTI and MTD channels had comparable high-angle performance near the airport. Simultaneous multi-scan photos of both MTD and MTI PPIs were taken to confirm identical coverage in this region near the sensor. Examples are shown in Appendix B which describes the MTD video reconstitutor.

C. System Software

A long standing goal of the FAA/LL MTD-II development program was to implement both the structured front-end high-speed digital signal processing, and the data adaptive post-processing algorithms in a programmable processor with a "small" number of card types, which could operate with programs stored in ROMs. The PMP-2 was developed during 1976-1977 with this capability, and there was a plan from the outset to demonstrate this feature. It was recognized early in the program that coding into this machine would be difficult, and post-processing algorithms would undergo a long development phase, thus it was decided to initially implement these algorithms in a commercial minicomputer, which could be coded, using a higher level language. This enabled us to demonstrate the entire system in real-time operation at an early date. Once the post-processing algorithms were "frozen", we planned to code the Correlation and Interpolation (C&I) algorithms into the Processing Module (PM) which was provided for this purpose.

Although C&I algorithms were still undergoing minor modifications, this task was started during October 1978. Coding was completed in approximately six months, and the real-time system was debugged and cycling in eleven months. A functional block diagram of the ASR-7/MTD-II test system is shown in Fig. IV-13. The PMP/PM was connected to the IEEE system bus, and received primitive target reports in parallel with the Data General Eclipse S/130 C&I processor. The PM formatted target reports and transmitted these to the Eclipse S/130 via the IEEE bus, for recording only. This system cycled in real time, during September, 1979, with both the PMP/PM and Eclipse S/130 performing the C&I function simultaneously. The algorithms which cycled were not identical, since the S/130 contained the "very" latests real-time version, while the PM was a few months "old". Still, the algorithms were close enough to be worth comparing against targets-of-opportunity in the local environment.

A fifty-scan sample of data was chosen to evaluate the relative performance of the PMP/PM/C&I compared to the S/130/C&I (which contained the specified algorithms). Fig. IV-14 shows a 49-scan record of the output of the

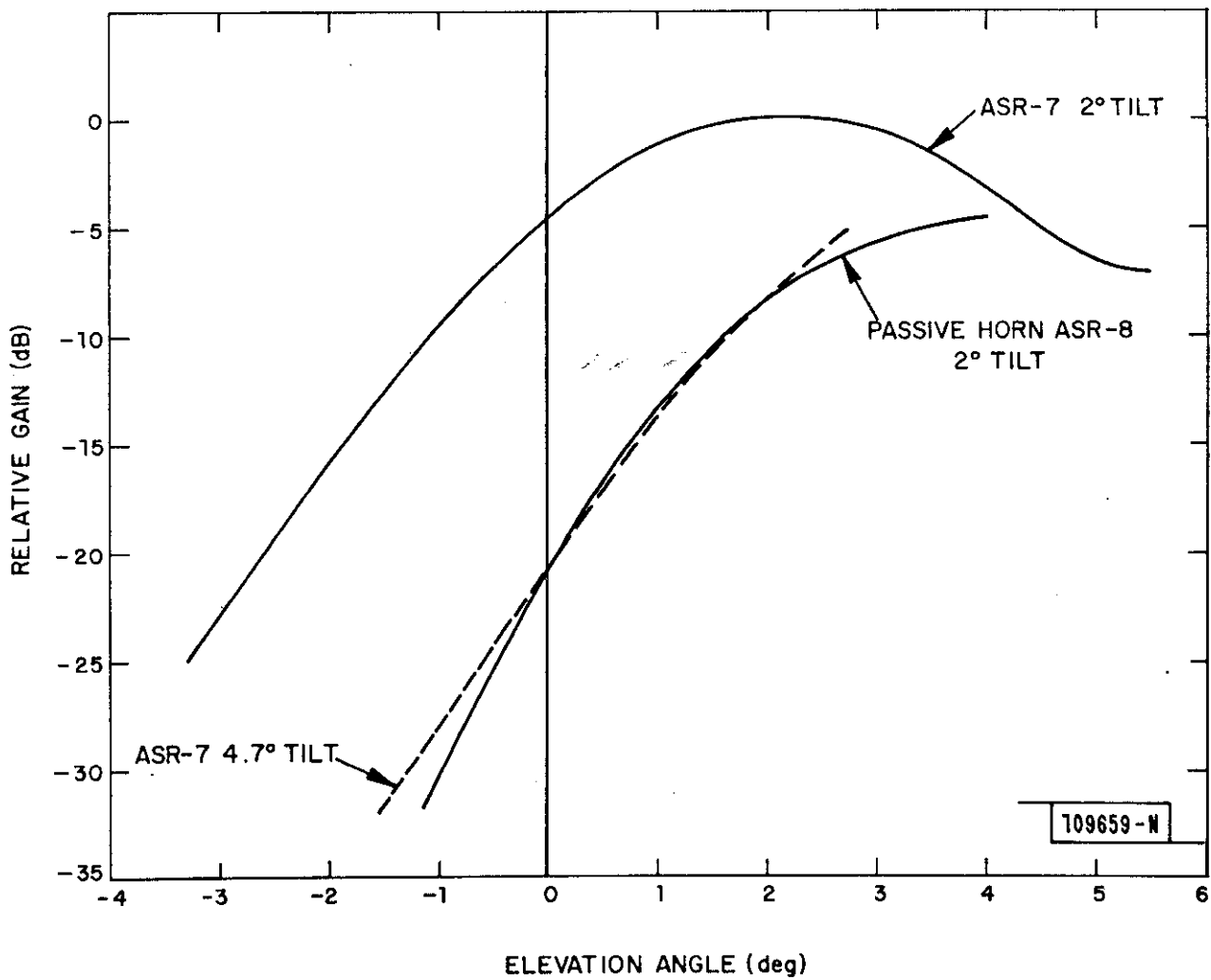

Fig. IV-12. ASR-7 antenna tilt to simulate ASR-8 passive horn.

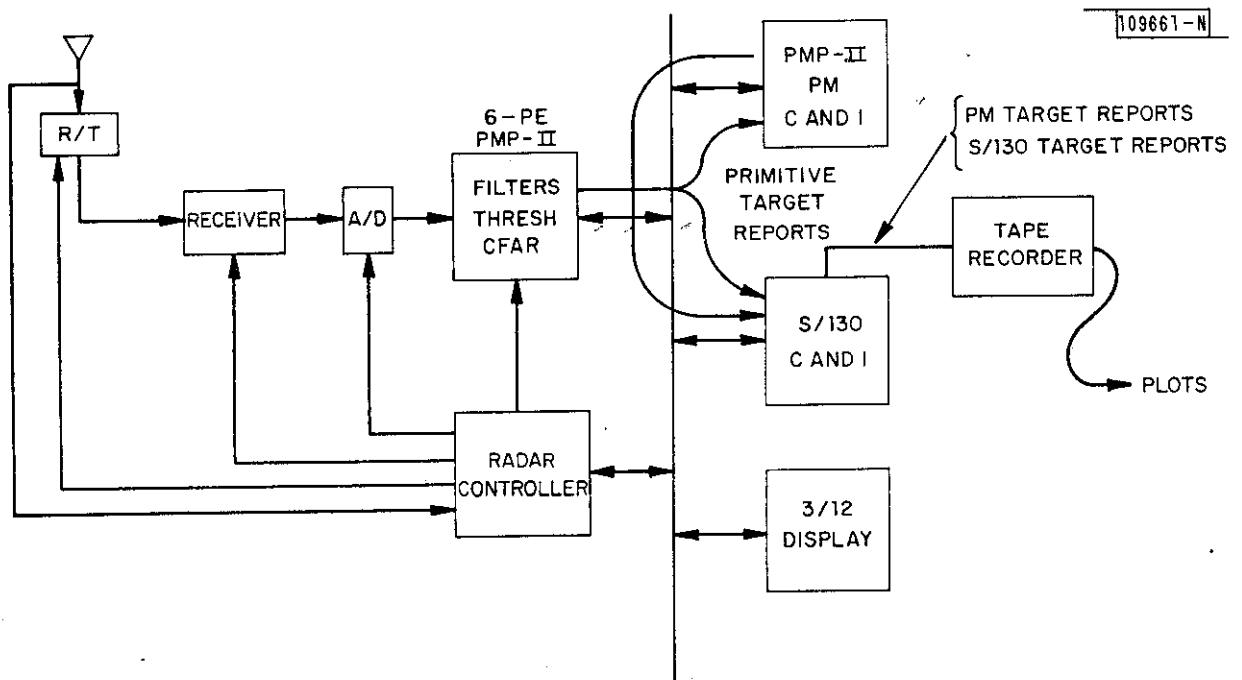

Fig. IV-13. PMP/PM C and I real-time system, functional block diagram.

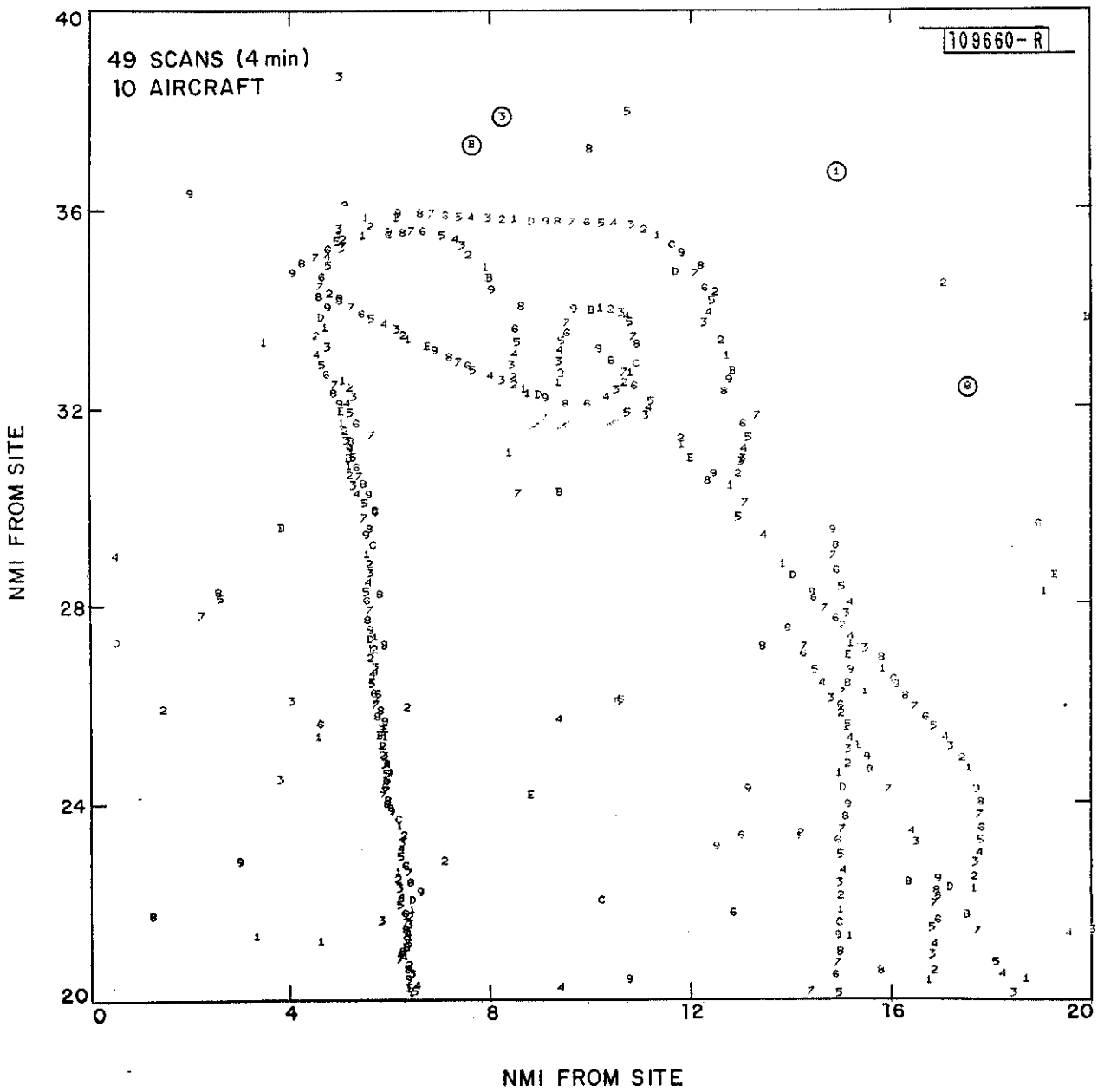

Fig. IV-14. PMP/PM C and I targets.

S/130 C&I in a 20 nmi x 20 nmi region to the Northeast of the Katahdin Hill ASR-7 radar site. There are ten A/C in coverage during this 4-minute interval. The P_d for these targets is 0.96 (358/374), and the noise false alarms in this coverage are consistent with a P_{fa} of 10^{-5} . During this interval, the same primitive target reports were processed by the PMP/PM in real time, and the C&I output is shown in Fig. IV-15. As can be seen by comparing these results, the correlation is "nearly" perfect. The PMP/PM/C&I agrees with the S/130 C&I in 361 of 374 A/C target reports, and 53 of 59 noise false alarms are in agreement. There are four noise false alarms (shown circled in Fig. IV-14), declared by the S/130 processor, that are not declared by the PMP/PM processor.

Although the PMP/PM/C&I code was not current (in minor respects), it produced the "same" clustered reports in 96% of the cases, for this sample of ten A/C tracks; better in 3 (80/73), the same in 5 (198/198), and worse in 2 (80/83). The agreement was "good enough" to consider PM/C&I to have been successfully implemented. This system could easily handle the DABS specified target loads in real time. The system used approximately 20% of real time while handling 5000 primitive targets per scan, and cycling diagnostic code in real time. It handled 100 clusters per second, and output clustered reports within 2-3 CPIs after closing the cluster. The input buffer could handle 40 CPIs at maximum rate of target declarations, compared to 24 CPI maximum specified. Details relating to organization of the PMP/PM Processor are contained in Appendix B.

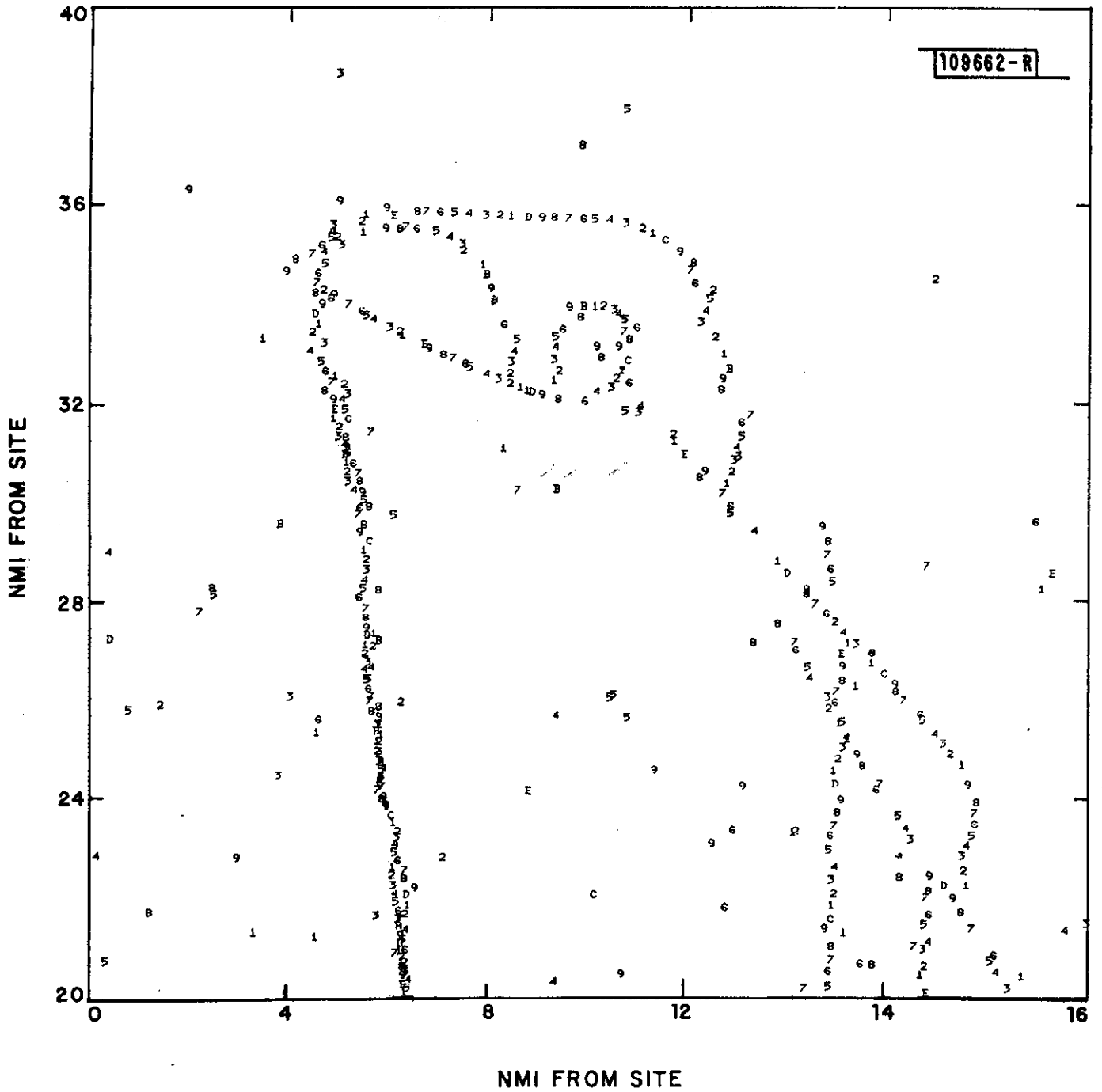

Fig. IV-15. PMP/PM C and I targets.

REFERENCES

1. L. Cartledge, R. M. O'Donnell, "Description and Performance Evaluation of the Moving Target Detector," Report No. FAA-RD-76-190, Lincoln Laboratory Project Report ATC-69 (8 March 1977).
2. R. M. O'Donnell, L. Cartledge, "Comparison of the Performance of the Moving Target Detector and the Radar Video Digitizer," Report No. FAA-RD-76-191, Lincoln Laboratory Project Report ATC-70 (26 April 1977).
3. C. E. Muehe, "The Parallel Microprogrammed Processor (PMP)," RADAR '77, London, England.
4. L. R. Rabner, J. H. McClellan, T. W. Parks, "FIR Filter Design Using Weighted Tchebyshev Approximation," Proc. of the IEEE (April 1975).
5. D. F. DeLong, Jr. and E. M. Hofstetter, "On the Design of Optimum Radar Waveforms for Clutter Rejection," IEEE Trans. on Information Theory (July 1967).
6. Ramon Nitzberg, "Low-loss Almost Constant False-alarm Rate Processors," IEEE Trans. on Aerospace and Electronic Systems (correspondence) (September 1979).

APPENDIX A

DEPARTMENT OF TRANSPORTATION
FEDERAL AVIATION ADMINISTRATION

TECHNICAL DATA PACKAGE

FOR

AIRPORT SURVEILLANCE RADAR

WITH MOVING TARGET DETECTION (ASR-MTD)

CONTENTS

	Page
1. SCOPE	A-1
2. APPLICABLE DOCUMENTS	A-1
3. REQUIREMENTS	A-1
3.1 Equipment and Services to be Supplied by the Contractor	A-1
3.1.1 Basic Hardware	A-1
3.1.2 Support Hardware	A-1
3.1.3 Software	A-3
3.1.4 Materials and Services	A-3
3.2.1 Performance Requirements	A-3
3.2.1.1 Surveillance	A-3
3.2.1.2 Capacity	A-4
3.2.1.3 Data Delays	A-4
3.2.1.4 Range Accuracy	A-4
3.2.1.5 Azimuth Accuracy	A-4
3.2.1.6 Two-Level Weather Contours	A-4
3.2.1.7 System Reliability	A-5
3.2.2 System Interfaces	A-5
3.2.2.1 Antennas	A-5
3.2.2.2 Transmitter Receiver Subsystem	A-5
3.2.2.3 Secondary Radar	A-5
3.2.2.4 ATC Facilities	A-5
3.2.3 Functions of ASR-MTD Processing Subsystems and Units	A-6
3.2.3.1 Radar Transmitter/Receiver	A-6
3.2.3.2 MTD Analog Receiver	A-6
3.2.3.3 System Timing and Control Unit	A-6
3.2.3.4 Special Purpose Interface Unit	A-7
3.2.3.5 MTD Processor	A-7
3.2.3.6 Correlation and Interpolation Processor (C&I)	A-8
3.2.3.7 Surveillance Processor	A-8
3.2.3.8 Display Processor	A-9
3.2.3.9 Performance Monitoring Display	A-9
3.2.3.10 Test Target Generator	A-9
3.3 Not Used	
3.4 ASR-MTD Design Requirements	A-9
3.4.1 Transmitter-Receiver Subsystem	A-9
3.4.1.1 Transmitter	A-10
3.4.1.2 Frequency Sources	A-10
3.4.1.3 Receiver	A-12
3.4.1.4 General	A-12

CONTENTS (Continued)

	<u>Page</u>	
3.4.2	MTD Analog Receiver	A-14
3.4.2.1	COHO Channel	A-14
3.4.2.2	Signal Channel	A-14
3.4.2.3	Phase Detectors	A-17
3.4.2.4	Matched Low-Pass Filters	A-17
3.4.2.5	Analog-to-Digital Converters (A/D)	A-17
3.4.3	Radar System Timing Unit (STU)	A-17
3.4.3.1	Radar Timing Signals	A-17
3.4.3.2	Radar PRF	A-17
3.4.3.3	Time Base	A-18
3.4.3.4	Data Acquisition Control Signals	A-18
3.4.3.5	CPI-to-Azimuth Synchronization	A-18
3.4.3.6	MTD Processor Timing Signals	A-18
3.4.3.7	Maintenance and Performance Monitoring Timing Signals	A-19
3.4.4	Analog-to-Digital Converter (A/D) Output Interface	A-19
3.4.5	MTD Processor	A-21
3.4.5.1	MTD Processor Inputs and Outputs	A-21
3.4.5.2	Major Functions of the MTD Processor	A-22
3.4.5.3	MTD Processor Performance Requirements	A-22
3.4.6	Correlation and Interpolation (C&I) Processor	A-35
3.4.6.1	C&I Processor Inputs and Outputs	A-36
3.4.6.2	Major Functions of the C&I Processor	A-37
3.4.6.3	C&I Processor Performance Requirements	A-37
3.4.7	Surveillance Processor	A-47
3.4.7.1	Surveillance Processor Inputs and Outputs	A-47
3.4.7.2	Major Processing Steps of the Surveillance Processor	A-47
3.4.7.3	Surveillance Processor Implementation	A-47
3.4.7.4	Surveillance Processor Performance Requirements	A-49
3.4.8	Display Processor	A-53
3.4.8.1	Display Processor Inputs and Outputs	A-54
3.4.8.2	Major Functions at the Display Processor	A-54
3.4.8.3	Display Processor Performance Requirements	A-54
3.4.9	Performance Monitoring	A-55
3.4.9.1	System Maintenance Status Display	A-56
3.4.9.2	Parameter Display	A-56
3.4.10	Test Target Generator	A-56
	Supplement A to Appendix A	A-57
	Supplement B to Appendix A	A-59

ILLUSTRATIONS

<u>Fig. No.</u>	<u>Caption</u>
3.1.1-1	Airport Surveillance Radar/Moving Target Detector, Overall System Block Diagram
3.4.1-1	Airport Surveillance Radar, Overall Block Diagram
3.4.1-2	Permissible Phase-Noise vs Frequency
3.4.2-1	MTD Analog Receiver, Block Diagram
3.4.4-1	A/D Output Interface, Block Diagram
3.4.5-1	MTD Processor, Block Diagram
3.4.5-2	MTD Processor, Alternative, Block Diagram
3.4.5-3	MTI Improvement Characteristic
3.4.5-4	Non-Zero Frequency Filter Characteristics
3.4.5-5	Zero Frequency Filter Characteristic
3.4.6-1	Correlation and Interpolation, Block Diagram
3.4.6-2	Target Report Amplitude Thresholding, Block Diagram
3.4.6-3	Target Cross Section Distributions
3.4.7-1	Surveillance Processor, Block Diagram
3.4.7-2	Scan-to-Scan Correlation State Diagram

APPENDIX A

TECHNICAL DATA PACKAGE FOR AIRPORT SURVEILLANCE RADAR WITH MOVING TARGET DETECTION (ASR-MTD)

1. SCOPE

This document specifies an air traffic control airport surveillance radar with high performance moving target detection and weather suppression capability. Realization of the radar may be by the addition of a Moving Target Detector (MTD) radar signal processing subsystem to existing Airport Surveillance Radars (ASR's), or by inclusion of the signal processing features within a new ASR from design inception. Addition of the MTD radar processing system to existing ASR's requires that modifications be made to the radar transmitter-receiver. Performance and design requirements for the hardware and software of the composite ASR-MTD, whether realized as a new or modified and expanded ASR system, are covered in this specification.

2. APPLICABLE DOCUMENTS

(By the FAA).

3. REQUIREMENTS

This specification covers an air traffic control surveillance radar with moving target detector signal processing system (ASR-MTD). The functional performance requirements stated herein shall be met by employing cost-effective design. Grouping of the functional performance requirements by "subsystem" and "unit" (system timing unit, MTD signal processor subsystem, etc.) in this specification is not intended to imply a specific architecture, and the contractor is encouraged to propose the most cost-effective implementation believed possible of the functions specified.

3.1 Equipment and Services to be Supplied by the Contractor.-

3.1.1 Basic Hardware.- ASR-MTD hardware consisting of an analog IF subsystem, analog-to-digital (A/D) converters, a digital signal processor, a surveillance processor, a system timing and control unit, a display processor, and a maintenance PPI shall be provided. An overall block diagram of the system is shown in Figure 3.1.1-1. MTD processing subsystems shall be provided for each radar channel. Switchover between radar signal processing channels shall be effected as a part of the channel change-over procedure.

Subsystems shall be provided to drive FAA ATC displays and to interface with a collocated beacon system.

3.1.2 Support Hardware.- A subsystem shall be provided for on-line performance monitoring of both the on-line and backup channels. This subsystem will include a special purpose interface between the A/D converters and the digital signal processor to provide access for a digital spectrum analyzer for measuring the coherence level of the radar system when required. A special purpose display processor is required to combine decoded beacon

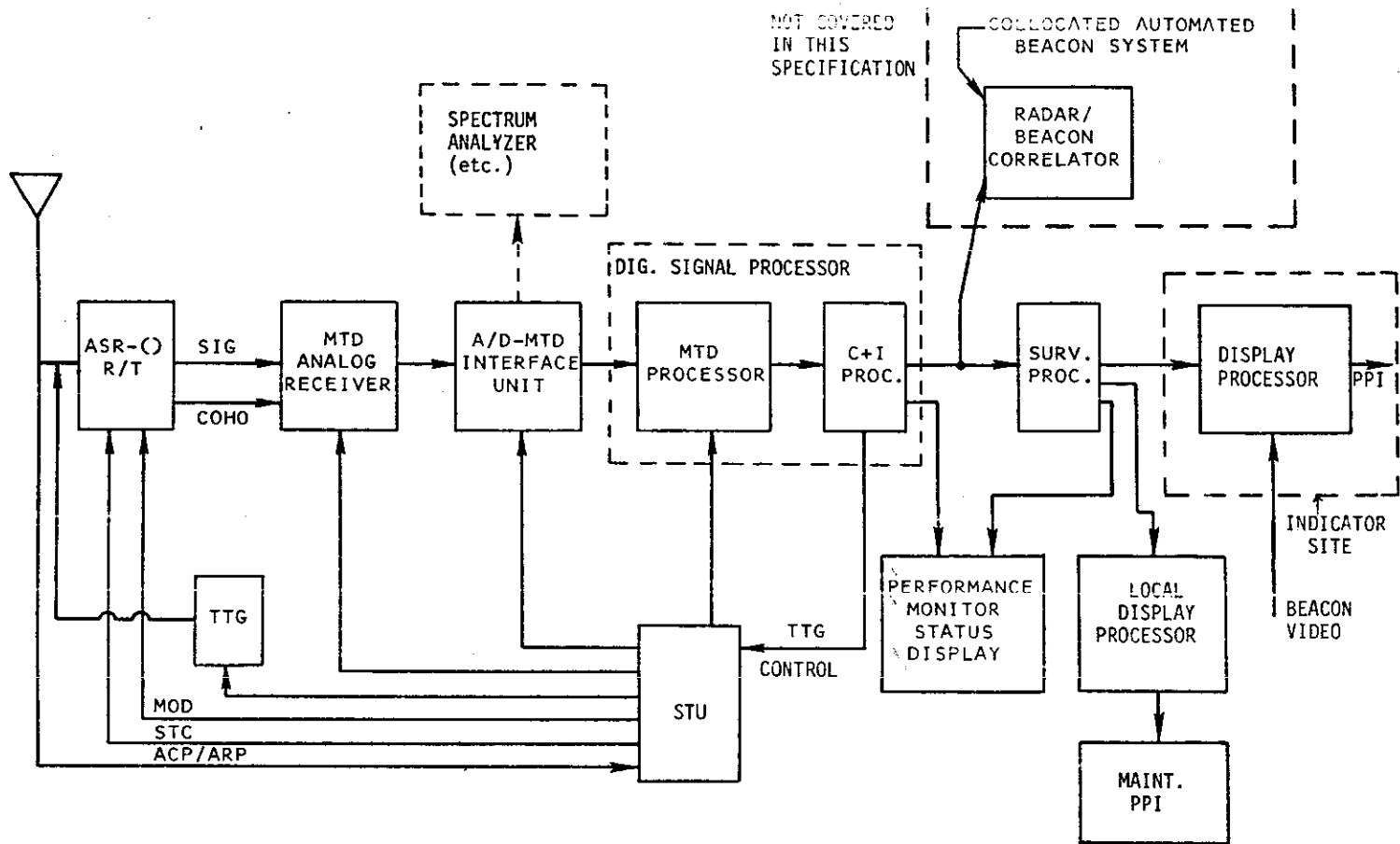

Figure 3.1.1-1 Airport Surveillance Radar/Moving Target Detector, Overall System Block Diagram.

signals, processed MTD radar target reports and two-level weather contour data, and to deliver two-level (on/off) video signals to the radar site maintenance PPI display and to the TRACON/TRACAB displays in ρ - θ format.

A test target generator shall also be provided to supply controlled moving target signals to the radar system for the on-line performance monitoring of each channel. A special purpose maintenance display shall indicate to maintenance personnel the status of individual subsystems.

3.1.3 Software.- Software required for each subsystem shall be provided as described in this specification. The software shall be modular such that it shall be possible to make relatively major changes without severe impact on the remainder of the system software.

The functions specified in this specification do not fully describe validity checking or error detection/correction procedures. The contractor shall incorporate such procedures in his computer programs in accordance with good programming practice. The realization of irrational numbers, transcendental functions, and stored constants shall make use of appropriate approximations, table lookup and interpolation to avoid costly computational techniques.

3.1.4 Materials and Services.- The contractor shall provide all necessary manpower and materials to design, fabricate, modify, assemble, deliver and install the Airport Surveillance Radar and Moving Target Detector system (ASR-MTD) specified in this document. Also, the contractor shall interconnect, test and demonstrate the ability of all subsystems to support the system performance requirements specified. The contractor shall provide all necessary services and materials to design, fabricate, test, and deliver all software specified herein. Any feature or item necessary for the proper operation and evaluation of the radar/radar signal processing system specified herein shall be incorporated even though that item may not be specifically described.

3.2.1 Performance Requirements.-

3.2.1.1 Surveillance.- The ASR-MTD radar shall perform surveillance of all aircraft within its coverage volume under all conditions of ground clutter, weather clutter and angel activity, consistent with radar system sensitivity, coherence, dynamic range and the level of adaptive thresholds. Maximum range shall be 60 nmi, site adaptable to shorter ranges when appropriate. When collocated with a non-automated radar beacon system, the ASR-MTD radar target reports shall be converted to two-level (on/off) video for display on standard FAA TRACON/TRACAB PPI displays (ρ - θ format). When collocated with beacon systems equipped with digital processing subsystems, for example DABS, the MTD radar shall output digitized radar target declarations after correlation and interpolation (C&I) to the beacon/radar correlator.

3.2.1.2 Capacity.- The ASR-MTD shall be capable of handling a total of 400 aircraft distributed uniformly or non-uniformly in azimuth, including limiting cases of non-uniform distribution as follows:

- (a) a peak of 25 aircraft uniformly distributed in an 11.25-degree sector, for not more than eight consecutive sectors.
- (b) a short-term peak of 12 aircraft in a 1.3-degree azimuth wedge, for not more than four contiguous wedges.

3.2.1.3 Data Delays.- ASR-MTD surveillance data shall be processed and available for beacon/radar correlation (after C&I) within 3/64 scan after the data is valid. ASR-MTD surveillance output to the display processor (after surveillance processing) shall be available within 10/32 scan after valid time.

3.2.1.4 Range Accuracy.- For an aircraft target with median S/N greater than 30 dB, the range errors shall not exceed $\pm 1/32$ -nmi bias and 200-ft. rms jitter.

3.2.1.5 Azimuth Accuracy.- For an aircraft target with median S/N greater than +30 dB and at an elevation angle of 1 degree-20 degrees with respect to the radar antenna horizontal plane, the ASR-MTD processor shall achieve an azimuth accuracy of 0.16 degrees, rms. For elevation angles greater than 20 degrees with respect to the horizontal plane of the radar antenna, the rms error shall not exceed $0.15/(\cos \text{ elevation angle})$ degrees.

3.2.1.6 Two-Level Weather Contours.- Estimates of rainfall rate (rain reflectivity) shall be developed by adding together signals over 1-nmi range intervals, compensating for range (centroid of this interval) and sensitivity-time-control (STC), and determining whether programmed levels of rainfall rate have been exceeded. Radar signal processing shall be effected in blocks of eight pulses (coherent processing intervals-CPIs) and there shall be at least 512 such intervals during each full scan of the radar antenna. Detection of weather-level threshold crossings shall be effected during alternate CPIs, at least 256 times during each full scan of the antenna. Smoothing of the threshold-crossing data shall be effected in the correlation and interpolation processor for formatting and transmission to either the beacon system or to the MTD surveillance processor, for output to analog display processing units. The estimates of rainfall rate thus derived, shall be accurate to within ± 3 dB (referred to nominal dBz value) for those range/azimuth cells in which the rain/fixed ground clutter is equal to or greater than +10 dB. For those range/azimuth cells where the fixed ground clutter signal is high compared to the rain-reflected signal the equivalent of a two-pulse canceller shall be used to reduce the ground clutter signal prior to contour smoothing. The error thus induced in estimating the rainfall rate in these cells shall be considered acceptable. Contours of two-levels of rainfall rate shall be developed and updated at intervals of six (6) scans.

3.2.1.7 System Reliability.- The principal elements of the MTD processing subsystem shall be designed for high reliability and minimum maintenance. Preventive maintenance shall be required no more frequently than once every 30 days. Mean-time-between-failure (MTBF) (functional failure) for each channel shall be 3,000 hours. Subelement MTD failures in either channel may occur within this 3,000-hr. period, but the ASR-MTD shall recover automatically, and alert maintenance personnel to the failure.

3.2.2 System Interfaces.-

3.2.2.1 Antennas.- The terminal ASR-MTD shall be designed to operate with terminal S-band antenna systems. Rotation rates from 12-15 rpm shall be accommodated. The antenna feed system may be connected for either linear or circular polarization when operating with the MTD radar signal processing subsystem. Linear polarization shall be considered the normal mode for achieving specified overall performance levels. When the system is operated in the circular polarization mode, weather contouring levels shall be decreased by 12 dBz to account for the reduction in gain reflected signals. The estimates of rainfall rate developed when operating in the circular polarization mode shall be accurate to within ± 10 dBz. The ASR-MTD timing and control subsystem receives signals from the antenna system azimuth change pulse (ACP) generator and from the azimuth reference pulse (ARP) generator. Four thousand ninety-six ACP's shall occur per scan and the ARP shall occur at magnetic north.

3.2.2.2 Transmitter Receiver Subsystem.- The transmitter receiver subsystem of the primary radar incorporated in the ASR-MTD shall provide the MTD analog receiver with 30 MHz IF signals. Noise level measured in a 4-MHz bandwidth at this interface shall be -70 dBm ± 6 dB into a 50-ohm resistive load. The MTD analog receiver shall also receive a coho 30 MHz IF signal from the primary radar. This signal shall be -20 dBm, -0 dB ± 10 dB as measured in a 50-ohm resistive load at the interface. Modulator and STC triggers required by the transmitter-receiver subsystem are provided by the ASR-MTD system time and control unit.

3.2.2.3 Secondary Radar.- The ASR-MTD processing subsystem shall accept decoded, digitized beacon signals from a non-automated beacon system, delay these signals and develop two-level (on/off) video signals coincident with MTD radar signals for driving analog ρ - θ PPI displays. The MTD shall also output radar target reports and weather contour data to digital processing subsystems for correlation and display.

3.2.2.4 ATC Facilities.- The terminal ASR-MTD processing subsystem shall provide radar and weather contour digital signals for transmission over narrow-band (2400 baud) lines between the radar site and the indicator site. The MTD display processing unit, installed at the indicator site, shall accept

the radar and weather contour data from the radar site, combine with two-level beacon, map, ACP and ARP signals, and develop aligned reconstituted two-level video for the indicator site PPI display systems.

3.2.3 Functions of ASR-MTD Processing Subsystems and Units.-

3.2.2.1 Radar Transmitter/Receiver.- This subsystem shall provide the signals required by the MTD processor. The transmitter/receiver group shall provide highly phase-stable signals as required when operating with the MTD processor.

3.2.3.2 MTD Analog Receiver.- This unit shall receive IF signals at 30 MHz, a coherent reference signal (coho), and range gate strobes (1/16 nmi or less). The IF signal shall be amplified, power divided and drive a log-magnitude detector (to provide a normal video signal for the maintenance PPI display and Transmitter/Receiver monitor, and two high level multipliers). The coho signal shall be amplified and quadrature power divided to drive the same two high level multipliers. The outputs of the multipliers shall be optimally low-pass filtered and shall provide in-phase (I) and quadrature phase (Q) bipolar video signals as inputs to two 10-bit A/D converters. The A/D converters shall be strobed each 1/16 nmi to transfer 10 bits I and 10 bits Q data to a special purpose interface unit which shall provide 20 bits of I&Q to a test port for spectral analysis (see para. 3.4.4) and 20 bits of I&Q to the MTD signal processor for filtering.

3.2.3.3 System Timing and Control Unit.- This unit shall provide all timing signals necessary to control the radar transmitter-receiver subsystem and the MTD processor timing functions. It shall a) provide for bursts of eight-pulse transmissions at each of two pulse repetition intervals (PRI) and, b) using ACP and ARP signals from the antenna, synchronize coherent processing intervals (CPI's) in order to support the creation of a synchronous clutter map using the zero-velocity filter.

A digital-finite impulse response (FIR) 8-point filter, centered at zero-velocity, as specified in paragraph 3.4.5, shall be used to measure the ground clutter amplitude in each range/CPI cell. The system timing unit (STU) shall synchronize 8-pulse CPIs from scan-to-scan to insure that the centroid of the CPI is repeated to within 1 ACP for proper updating of a fixed ground clutter map.

This unit shall provide modulation triggers to the transmitter, STC triggers to the receiver front end, display triggers to analog displays, beacon triggers, strobes to the I&Q A/D converters, all of the necessary data memory strobes to the MTD processor and shall provide the absolute ACP count to the MTD processor each CPI. This unit shall also provide staggered PRI bursts to the system when the antenna is stopped for single range gate coherence measurements (see para. 3.4.3.7) and provide triggers to the system test target generator under manual or program control.

3.2.3.4 Special Purpose Interface Unit.- This unit shall receive 24 bits of I&Q data and a data ready strobe from the A/D converters and an external sample pulse, provide a sampled and buffered output (24 ports plus data ready strobe) to special test equipment for analyzing spectra, and provide buffered output (24 ports plus data ready strobe) to the MTD signal processor's toggled data memory.

The overall system stability shall be measured with these sampled I and Q outputs. With the antenna spotlighted (fixed) on a stationary specular target, and operating at the normal staggered PRF rate, a 64 point Fourier transform of this target return shall yield a noise floor of no greater than -78 dB.

3.2.3.5 MTD Processor.- The MTD Processor shall receive and store eight samples of 24 bits each (I&Q) for each of up to 960 range gates during a CPI and shall process the sampled data received during the previous CPI. It shall use an input data memory to permit processing while receiving.

The processor shall test for A/D overload (saturation) and pulsed interference, and shall eliminate all data for the eight pulse group in which either saturation or interference (S/I) was detected. It shall perform digital filtering using eight pulses for each range gate, and shall develop normalized output magnitudes for each of eight filters. It shall develop and update a synchronous clutter map using the output of the zero-velocity filter in an auxiliary memory unit. It shall perform adaptive CFAR by developing mean-level-thresholds over 16 gates (1 nmi) bracketing the gate of interest, for each of the seven non-zero velocity filters. It shall declare a primitive target detection by filter and by range when the threshold(s) for that cell(s) is exceeded. It shall compare the zero-velocity filter amplitude with the clutter map for possible primitive target declaration during each CPI. This unit shall sum the amplitudes of all filters over one nmi range intervals and compare the result of two programmable threshold levels for detection of rain. This unit also shall sum the amplitudes of all non-zero velocity filters over one nmi range intervals and compare the result to two programmable threshold levels for detection of rain.

The processor shall format messages indicating primitive target declarations and shall append range, azimuth, amplitude, velocity (filter number), which CPI (high frequency or low frequency), and system performance.

The processor shall also format weather detection messages indicating the range at which either of two thresholds was exceeded. These data are transmitted to the correlation and interpolation unit for further processing.

The processor shall be microprogrammable and shall have certain parameters (i.e., fixed thresholds, see para. 3.4.5) selected by ROM option for each radar site.

*System performance status shall be defined by the contractor.

3.2.3.6 Correlation and Interpolation Processor (C&I).- The C&I processor shall receive primitive target reports and weather contour data from the MTD processor. Its principal function shall be to correlate (i.e., cluster) primitive target reports which are associated with a single, moving, aircraft target, normalize their amplitudes by filter (velocity) and interpolate (estimate) for most likely range, azimuth, velocity and amplitude. As the antenna scans by moving aircraft targets, a number of primitive target reports may be declared during each CPI and the target may be above threshold for as many as eight CPI's. Thus, large numbers of primitive target reports (50) may be associated with a single moving target. The C&I processor shall develop a single target report for each separable cluster of primitive reports, and provide an estimate of range (1/32 nmi), azimuth (1 ACP), velocity (filter to 1/64 of unambiguous interval) and normalized amplitude. The target report also includes the number of primitive target declarations associated with the report. The unit shall be microprogrammable and shall have certain parameters (censorable range-azimuth cells for moving ground traffic) selected by ROM option for each radar site. It shall develop adaptive amplitude thresholds (second thresholds of targets the MTD having thresholded initially) to prevent system overload under conditions of severe "angel" activity. This unit shall format radar target reports for transmission to the surveillance processor and to the colocated radar beacon correlator when applicable.

The C&I processor shall receive two-level weather threshold crossings from the MTD signal processor, during alternate CPIs. It shall contain a range/CPI map (developed for each site) which shall be used to select threshold crossings from either the sum of all filters or from the sum of non zero-velocity filters. This technique shall be used to eliminate false weather threshold crossings over high amplitude ground clutter. The processor shall "smooth" the data in range (eliminating single isolated detections which may be caused by aircraft targets) and determine the range(s) at which each of two rain-rate thresholds was crossed during this CPI. It shall develop a two-level, contoured weather map and format these data for transmission to the surveillance processing radar system when applicable. This subsystem shall monitor certain parameters (e.g. TTC outputs) in support of on-line performance monitoring functions and output data to a special purpose maintenance display unit.

3.2.3.7 Surveillance Processor.- The surveillance processor shall receive target reports and weather contour data from the C&I processor. Although the MTD and C&I processors have been optimized to provide accurate moving aircraft target reports, while eliminating most false target reports due to clutter break-through, moving ground traffic, rain, and angels, there can be, on the order of, 60 false target reports per scan. It shall be the function of the surveillance processor to use scan-to-scan target history to identify displayable aircraft target reports (within two to five scans) while flagging

(or eliminating) those false target reports which are not associated with moving aircraft targets. Under normal operating conditions the false target reports will not be correlated and will not form "many" displayable reports. Under unusual environmental conditions (ducting) or under conditions of extreme "angel" activity, false target reports may be correlated and the rate of display of false reports may increase. The surveillance processor shall output fewer than 1.0 false target reports per scan averaged over a 1-hr period, during normal operating conditions. The peak rate of display of false radar targets shall be fewer than 10 per scan averaged over one hour, under extreme conditions of "angel" activity or ducting. This processor unit shall format and transmit displayable radar target reports and weather contours to the display processor and output data to the maintenance display to support on-line performance monitoring functions.

3.2.3.8 Display Processor.- The display processor shall receive radar target reports and weather contours from the surveillance processor, beacon video from the 12x12 decoder, radar timing triggers and ACP/ARP pulses from the system timing and control unit. The MTD radar reports may be delayed up to 10/32 scan under heavy traffic loads, thus the beacon video, triggers and ACP/ARP pulses shall be delayed by 10/32 scan in order to align beacon, radar reports, weather and map data on a reconstituted two-level video PPI display. The processor shall provide these signals to the local maintenance PPI display and to the TRACON/TRACAB displays. Delayed ACP/ARP pulses shall be provided to the video mapper to align this system with radar/beacon targets.

3.2.3.9 Performance Monitoring Display.- This unit shall display alpha- numerics and activate indicators for use by maintenance personnel to determine the status of either the on-line or backup ASR-MTD system. Inputs shall be provided by each subsystem in suitable form and format.

3.2.3.10 Test Target Generator.- The test target generator shall have the capability of simulating real moving targets for insertion into the system at RF in order to provide on-line performance monitoring of the MTD processor subsystem.

3.3 Not Used.-

3.4 ASR-MTD Design Requirements.-

3.4.1 Transmitter-Receiver Subsystem.- The Transmitter-Receiver Subsystem shall be dual-channel, operate at S-band and provide coverage of moving aircraft in the ATC terminal area, and out to 60 nmi. Aircraft shall be assumed to exhibit Swerling Type I fading statistics and to be of mean radar cross section of at least one square-meter (0 dBsm). Stated performance requirements shall be met when the transmitter-receiver subsystem is interfaced with standard FAA ASR rotating antenna systems such as the ASR-7 and ASR-8.

This section emphasizes transmitter-receiver requirements which are critical to the proper performance of the MTD processor subsystem. Individual unit specifications are consistent with the overall primary radar system requirements, but by themselves, cannot insure that the overall moving target detection requirements be met. Should an apparent contradiction arise between overall requirements and a subunit specification, the overall requirements shall take precedence.

A functional block diagram of one channel of a candidate transmitter-receiver subsystem is shown in Fig. 3.4.1-1 to illustrate the principal elements described in this specification.

3.4.1.1 Transmitter.- The transmitter shall be a gain/phase-stable, gated, high-power, pulsed amplifier. It shall accept an S-band CW signal (2700-2900 MHz) and a modulator trigger signal and shall develop a trapezoidal output pulse of 800-900 nsec duration, measured at the -6 dB points, with rise and fall times of 100-nsec duration measured at the 0.1 dB and -40 dB points (the 1% and 99% points). The peak output power measured at the output of the waveguide switch shall be 0.5 MW or greater. The CW signal input to the transmitter shall be 100 mW within ± 3 dB.

The transmitter shall be capable of operating with alternating 8-pulse CPIs with a maximum average PRF of 1200 Hz. The pulse-to-pulse rms phase instability during each 8-pulse CPI shall be equal to or less than 0.06 degrees. The rms pulse-to-pulse timing instability (jitter) during each 8-pulse CPI shall be equal to or less than 5 nsec.

3.4.1.2 Frequency Sources.- The radar system shall use highly stable frequency sources to insure that the total system instability residue prior to coherent filtering shall be equal to or less than -48 dB referred to peak signal (+51 dB S/N) at all ranges to 60 nmi.

3.4.1.2.1 Stable Local Oscillator (STALO).- This unit shall be a crystal-controlled phase-locked oscillator operating at one S-band frequency (2700-2900 MHz ± 30 MHz) and capable of outputting +20 dBm ± 3 dB after a two-way power divider. The output power shall be stable to within ± 0.5 dB over a 30-day period, and to within ± 1.0 dB over a 20,000-hr. period. The output frequency shall be accurate to within one part in 10^5 , and the long-term drift shall be no worse than \pm one part in 10^7 per year. The short-term stability shall be based on phase-noise as it affects the cancellation ratio seen through a two-pulse canceller.

An expression for the cancellation ratio is given by:

$$CR = 8 \int_0^{\infty} \sin^2(\pi f \tau) \cdot \sin^2(\pi f T) S_{\phi}(f) df$$

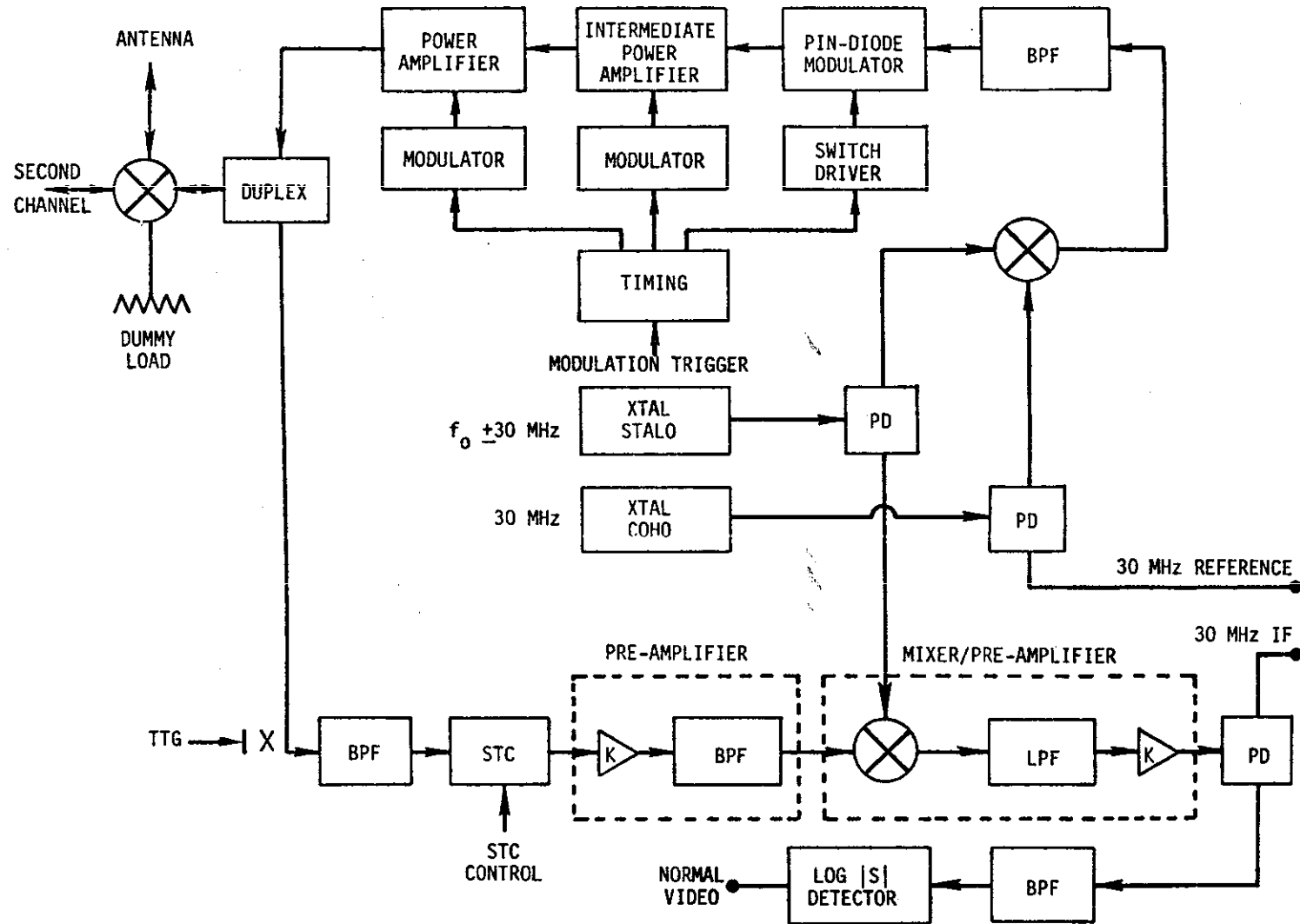

Figure 3.4.1-1 ASR-MTD Transmitter-Receiver Subsystem, Overall Block Diagram.

where: τ = round-trip time = 250 μ sec (20 nmi)

T = PRI = 1000 μ sec

$S_{\phi}(f)$ = single side-band phase-noise spectrum

To achieve a cancellation ratio in excess of 50 dB at 20 nmi (250 μ sec), the stalo phase-noise vs. frequency must be no worse than that shown in Fig. 3.4.1-2.

3.4.1.2.2 Intermediate Frequency (IF) Coherent Oscillator. - This unit shall be a stable crystal-controlled oscillator, operating at 30.0 MHz and capable of outputting +20 dBm -0 dB +3 dB after a two-way power divider. The output power shall be stable to within +0.5 dB over a 20,000-hr. period. The frequency shall be accurate to within one part in 10^5 , and the long-term drift shall be no worse than + one part in 10^5 per year. The short-term stability shall be based on phase-noise as it affects the cancellation ratio as seen through a two-pulse canceller. This unit (coho) shall have phase-noise vs. frequency no worse than -20 dB referred to the stalo in order that it not affect the cancellation ratio determined by stalo phase instabilities.

3.4.1.3 Receiver. - This unit shall be a stable, sensitive, wide-dynamic-range S-band receiver as shown in Fig. 3.4.1-1. It shall employ a multi-section input bandpass filter centered at the radar operating frequency with a 3-dB bandwidth of 24 MHz, a 60-dB bandwidth of less than 72 MHz, and insertion loss of less than 0.5 dB. The loss outside of the 72-MHz band centered at the operating frequency shall be at least 60 dB. The receiver shall use a PIN-diode modulator operating as a sensitivity vs. time control unit (STC) ahead of the preamplifier to provide controlled attenuation vs. range. This unit shall have a transfer function which is approximately linear (within +1 dB) in dB/volt over the range -0.7 dB to -44 dB. It shall accept video drive signals in the range 0 to 12 volts into a 50-ohm circuit. The receiver shall use a solid-state, low-noise (3.0 dB or better) preamplifier with input limiter protection against the transmitter pulse leaked by the system duplexer. This unit shall have adequate gain to reduce second stage noise effects to less than 0.5 dB. A bandpass filter shall be used following the amplifier to reject image frequency noise generated in the amplifier. The 1-dB compression point of this unit shall be equal to or greater than +10 dBm. The receiver shall use a high-level mixer preamplifier following the front-end amplifier to convert the input S-band signal to a 30-MHz IF signal for transmission to the MTD analog receiver and to a bandpass filter/log magnitude detector unit for deriving a normal radar video signal. This unit shall operate with a high-level local oscillator (stalo) providing +20 dBm drive, and shall have an output 1-dB compression point equal to or greater than +30 dBm.

3.4.1.4 General. - Additional elements (duplexer, monitoring functions, etc.) not covered in this section of the specification, but which are required to

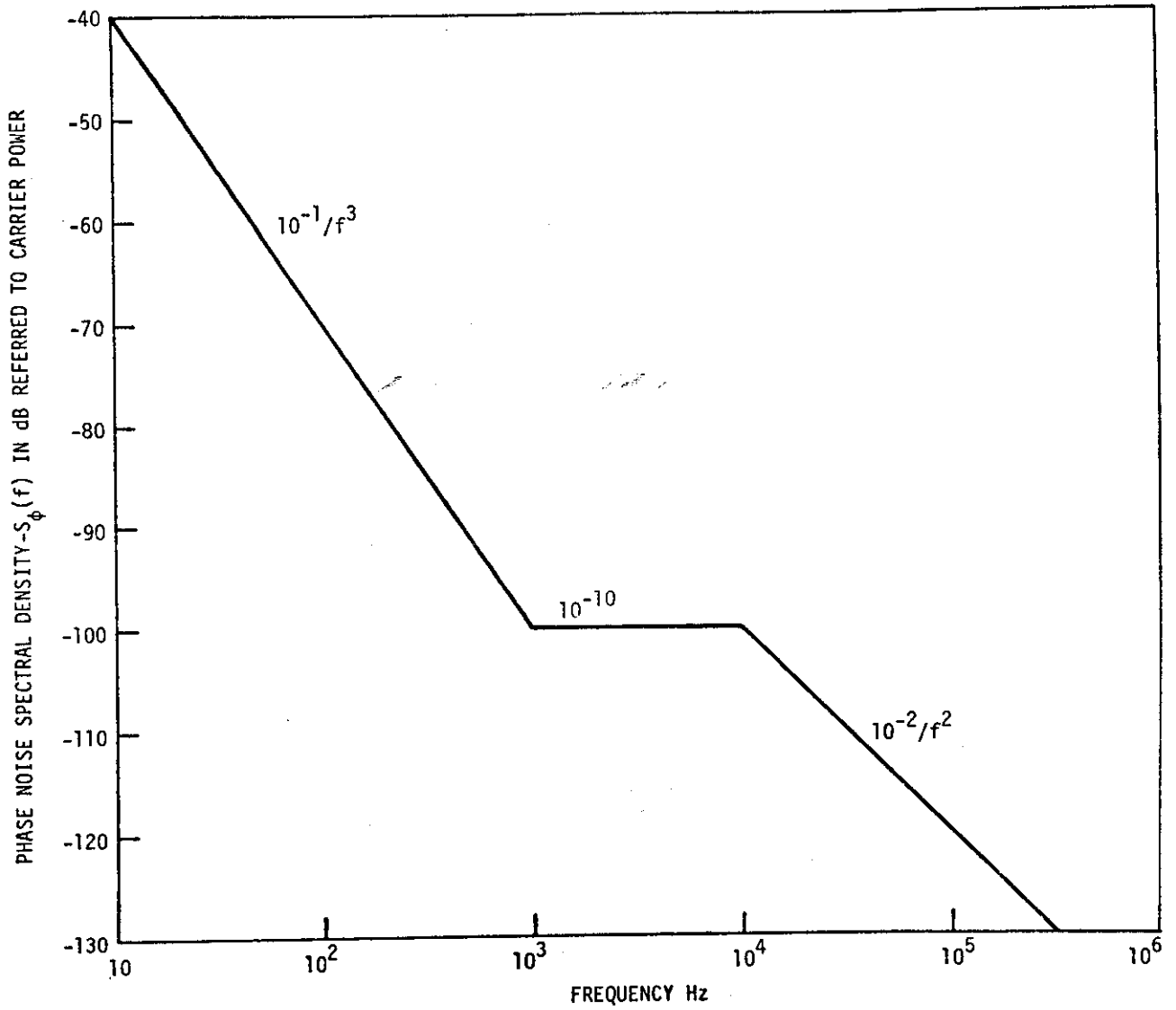

Figure 3.4.1-2 Permissible Phase-Noise vs Frequency

complete the primary radar, shall be implemented in accordance with standards established for existing FAA/ATC primary radar systems. The subsystem elements which are covered in this section of the specification are considered critical to supporting stable, coherent, automated terminal radar operation with MTD processing.

3.4.2 MTD Analog Receiver.- This section defines the analog MTD receiver design requirements and describes a hardware realization which can perform the necessary functions. It is not intended to limit the MTD receiver design to the realization described. A functional block diagram, Fig. 3.4.2-1, shows the elements of the MTD analog receiver. The individual subunit specifications contained herein are consistent with the overall system requirements but, by themselves, cannot insure that the overall requirements can be met because of the careful interconnection of the components and subunits required in this application. Should an apparent contradiction arise between overall requirements and a subunit specification, the overall requirements shall take precedence.

3.4.2.1 COHO Channel.- The coho channel shall receive the 30-MHz reference signal from the primary radar at a level of +20 dBm (100 mW), provide variable input attenuation, bandpass filter the signal, amplify the signal to a level of +30 dBm, drive a passive quadrature ($\pi/2$) hybrid power divider, and then drive two high-power, double-balanced, quad-diode phase detectors.

The variable input attenuator shall be used to control the reference coho drive level at the two phase detectors. The nominal level at the input to the phase detectors shall be +27 dBm, to support "linear" operation.

A bandpass filter centered at 30 MHz shall be used in the coho channel to isolate this network from out-of-band spurious signals. This filter shall be a three-pole Butterworth design with 3-dB bandwidth equal to 4 MHz. The insertion loss of this filter shall be less than 4 dB. A high-power, linear, 30-MHz amplifier shall be used to raise the coho signal level to +30 dBm. The 1-dB compression point of this amplifier shall be +36 dBm or greater.

A passive quadrature hybrid power divider shall be used to develop two coho reference signals of equal amplitude and 90-degrees phase difference. The differential amplitude between the two ports shall be equal to or less than 0.25 dB, and the differential phase shall be 90 degrees \pm 2 degrees.

All of the circuitry in the coho channel shall be designed to operate at 50 ohms.

3.4.2.2 Signal Channel.- The signal channel shall receive the 30-MHz IF signal from the primary radar at a level of -70 dBm (effective noise bandwidth of 1.4 MHz), provide variable input attenuation, bandpass filter the signal,

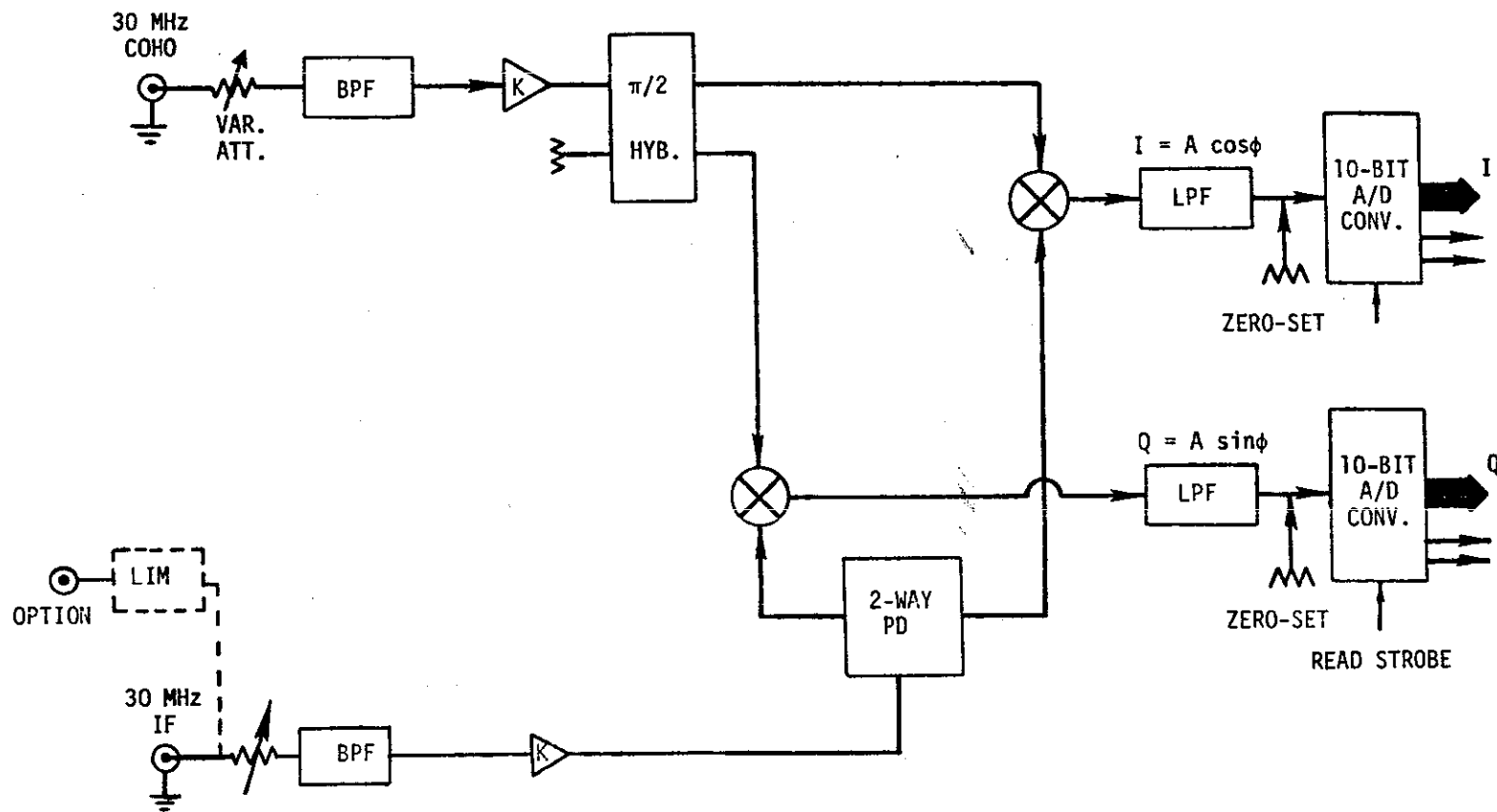

Figure 3.4.2-1 MTD Analog Receiver - Block Diagram.

amplify the signal by approximately 54 dB, drive a passive two-way power divider, and then drive two high-power, double-balanced, quad-diode phase detectors.

The variable input attenuator shall be used to control the noise level at the input to the A/D converters. The nominal level at this point shall be 2 mV rms into 50 ohms. This is equivalent to one quantum level of the A/D converters and accurate setting of this level is required to insure that the full dynamic range of the processor is utilized. There shall be adequate range in the attenuator to permit ± 10 dB variations about the nominal level.

A bandpass filter (same as that used for the coho channel) centered at 30 MHz shall be used in the signal channel to isolate this network from out-of-band spurious signals.

A high-power, linear, 30-MHz amplifier shall be used to raise the signal level to a point sufficient to produce 2 mV rms noise at the input to the A/D converters. The gain/loss budget of this channel shall be such that the gain of the amplifier is approximately +54 dB. (Note: typical losses are: variable attenuator 10 dB, bandpass filter 3 dB, two-way power divider 3 dB, phase detector 8 dB, and matched low-pass filter 1 dB. The input level is -70 dBm and the nominal required output level is -41 dBm (2 mV rms into 50 ohms), requiring a net gain of +29 dB. Since the nominal losses are -25 dB, the amplifier net gain must be +54 dB). The 1-dB compression point of this amplifier shall be equal to or greater than +36 dBm.

The dynamic range of the MTD processor is limited by the 10-bit A/D converters to peak signal/rms noise of +54 dB. A peak signal input to the A/D converters (+1.024 volts) will have a peak of +13 dBm. To insure that the receiving system is linear to this point, the signal channel amplifier/phase detector combination must introduce less than -40 dB intermodulation distortion (odd order terms) when subjected to a two-tone test at maximum level (each tone output at +7 dBm). A passive two-way power divider shall be used to develop inputs to the two phase detectors. The differential amplitude between the two ports shall be less than 0.1 dB and the differential phase shall be 0 degrees ± 2 degrees.

All of the circuitry in the signal channel shall be designed to operate at 50 ohms.

The signal channel shall have optional provision for introducing a broadband (10 MHz) I.F. limiting amplifier ahead of the I.F. bandpass filter for use at terminal radar sites with excessive overloading clutter returns (more than 100 range/CPI cells with peak clutter/noise equal to or greater than +54 dB). The output level of this amplifier shall be adjustable to insure that the rms noise level into the A/D converters can be set to 2 mV, -0 dB ± 10 dB. Circuitry shall be provided to allow for zero-setting at the input to the A/D converters.

3.4.2.3 Phase Detectors.- The phase detectors shall be high-power, double-balanced, quad-diode units capable of being operated with local oscillator drive levels of +27 dBm. The transfer loss of these units shall be equal to or less than 8 dB.

3.4.2.4 Matched Low-Pass Filters.- The low-pass filters following the quadrature phase detectors shall be 4-pole Bessel designs. The 3-dB bandwidth shall be 0.67 MHz matched to an 833-nsec CW pulse. If the primary radar pulse is other than 833 nsec in duration, then the 3-dB bandwidth of this filter shall be adjusted accordingly to retain a match. The filters shall be 50-ohm input/output units, and shall be isolated at the input by 1-dB resistive pads.

3.4.2.5 Analog-to-Digital Converters (A/D).- The A/D converters shall be high-speed, 10-bit units capable of operating at sampling rates to 3 MHz. The units shall operate at approximately a 1.3-MHz sampling rate in this application (1/16 nmi or 772-nsec read cycle spacing), and shall have processing delays equal to or less than 400 nsec. This unit shall introduce differential processing delays no greater than 100 nsec, and shall have an aperture time equal to or less than 100 picosec. The input shall be a 50-ohm resistive termination and all digital output ports shall be TTL compatible.

3.4.3 Radar System Timing Unit (STU).- The STU shall provide the basic timing signals for the operation of the radar and for the data acquisition circuits of the MTD processor. It shall control and synchronize all processing with respect to a set of pre-selected antenna positions. The STU shall also provide timing signals for the system test and monitoring equipment.

3.4.3.1 Radar Timing Signals.- The radar timing signals to be provided for each radar sweep shall be as follows:

- (a) Beacon trigger pulse
- (b) Display trigger pulse
- (c) STC trigger pulse
- (d) Modulator trigger pulse
- (e) Coherent oscillator gating pulse
- (f) Two spare trigger pulses

The timing of these pulses shall be adjustable over the pretrigger period, defined as the time between T_o , the time at which the main RF pulse is transmitted, and 128 range gates prior to T_o .

3.4.3.2 Radar PRF.- The PRF of the radar sweeps shall be constant within a given CPI. However, the PRF for the following CPI shall be different. The

difference shall be 20%. The PRF's shall alternate between these two values for alternate CPI's.

3.4.3.3 Time Base.- The time base for the radar must be synchronous with that of the data acquisition system of the signal processor. Thus, both time bases must be derived from the same source. To reduce potential interference from IF leakage, this source shall be derived from, or locked to, the IF coherent oscillator. The time quantization shall be equivalent to $1/32$ nmi or less. The accuracy of this time base shall be better than 10^{-5} . At least one derived signal, with period equivalent to or less than $1/16$ nmi shall be available for use in range gate sampling by the data acquisition circuits.

3.4.3.4 Data Acquisition Control Signals.- The data acquisition control signals shall consist of the following.

- (a) The received signal analog-to-digital (A/D) encode command pulses (the range gate sampling signal) specified in para. 3.4.3.3.
- (b) Data gate signals to the signal processor to control the data memory input timing. In order to suppress nearby high clutter areas, the start of the data gates shall be adjustable so that up to 16 nm from range zero can be bypassed. The adjustment shall be in $1/2$ nm (or less) increments. The duration of these data gates shall be adjustable to provide the required radar range segment coverages.

3.4.3.5 CPI to Azimuth Synchronization.- The STU shall synchronize the alternate CPI's to a set of preselected antenna positions so that a coherent ground clutter map can be established. The synchronization timing error shall be less than one PRI. This synchronization shall be maintained over antenna speed variations caused by normal wind loading and by mechanical imperfections.

The STU shall also provide passive horn switching signals to the receiver over selected azimuth-range swaths.

3.4.3.6 MTD Processor Timing Signals.- The STU shall provide the MTD processor with the following signals.

- (a) A signal (or signals) indicating the start and the end of a CPI. A CPI shall start with the beginning of the data acquisition period of the first sweep; it shall end with the end of the data acquisition period of the 8th sweep of that CPI.
- (b) The antenna position information at the start (or end) of a CPI. The antenna position information shall be derived from the azimuth reference pulses (ARP) and the azimuth change pulses (ACP).
- (c) The PRI (high or low) used for the current CPI.

3.4.3.7 Maintenance and Performance Monitoring Timing Signals.- The STU shall provide the following timing signals to the radar system test and monitoring equipment.

- (a) A trigger signal for the maintenance oscilloscope. This signal shall precede all signals generated during a radar sweep.
- (b) A scope trigger at the start of a CPI and a trigger at the start of a CPI pair.
- (c) A trigger to the test target generator (TTG). The timing of this trigger shall be adjustable over the entire pretrigger period using switches on the front of the STU.
- (d) A single gate processing (SGP) pulse for system testing. This pulse shall be generated once per radar sweep and its timing shall be easily selectable over the entire interpulse (sweep) period. It shall be in synchronism with an A/D encode pulse. The SGP test is usually performed with the antenna in a spotlight (stopped) position. In order to provide the alternate PRI bursts under this condition, the STU shall simulate ACP's and ARP's and provide them to the other part of the system such as the TTG. A manual mode control may be used for this condition.

3.4.4 Analog-to-Digital Converter (A/D) Output Interface.- The A/D output interface shall provide buffered digital signals to the signal processor. It shall also provide a set of holding registers to sample the A/D outputs at specific times. The holding register's outputs shall be available to external test equipment. Two modes of sampling shall be provided, one using the SGP pulses of para. 3.4.3.7 and the other using the A/D encode command pulses of para. 3.4.3.4(a).

The sample A/D outputs shall be used for system tests (such as the SGP tests) or for monitoring.

This interface shall have a set (2) of fast digital-to-analog (D/A) converters to provide analog signals to external monitoring equipment for observation of the digitized I and Q receiver signals. These D/A's shall be connected to the holding registers. The resolution of these D/A's shall be 2^{-10} or better. Their settling time shall be less than 10 ns and their outputs shall be filtered by deglitching or other equivalent circuits. A functional block diagram of the A/D output interface unit is shown Fig. 3.4.4-1.

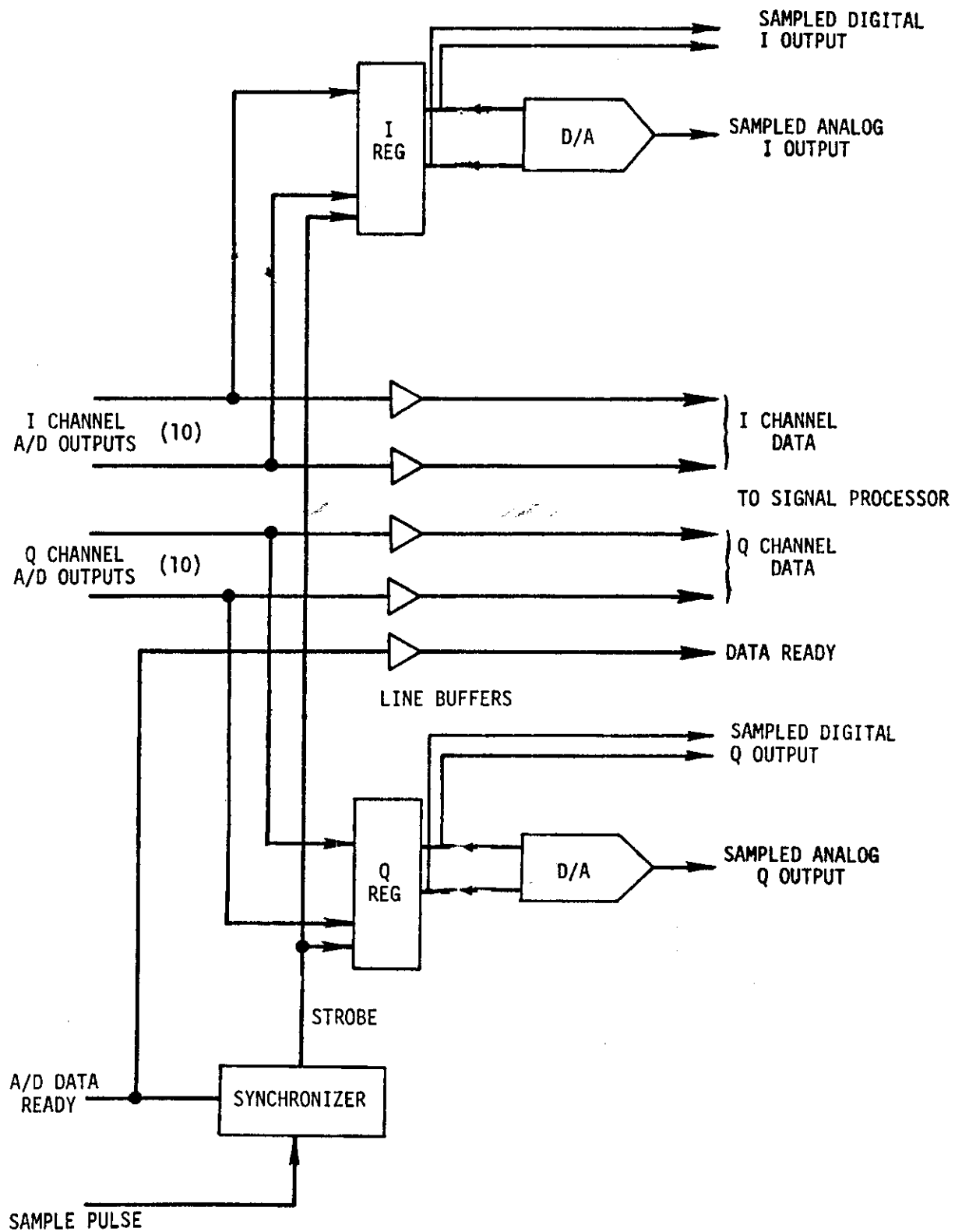

Figure 3.4.4-1 A/D Output Interface, Block Diagram

3.4.5 MTD Processor.- The MTD processor shall be a special-purpose computer which accepts digitized quadrature video words (I and Q) from the A/D converters, processes them to detect moving targets and to reject fixed ground clutter, precipitation clutter, and pulsed interference, and passes messages to the correlation and interpolation unit (C&I unit) to indicate the presence of the moving targets and the location and intensity of the precipitation.

3.4.5.1 MTD Processor Inputs and Outputs.- The inputs to the MTD processor shall be:

- (a) In-phase (I) A/D interface output (10 bits)
- (b) Quadrature-phase (Q) A/D interface output (10 bits)
- (c) Input memory control strobes from the A/D converters
- (d) CPI-type strobe from the STU
- (e) CPI azimuth centroid from the STU (12 bits)
- (f) Range coverage gates, if required
- (g) PRI for this CPI

The output of the MTD processor shall consist of primitive target reports for the CPI being processed. The primitive target reports shall contain the following information:

- (a) Target range (20 bits)
- (b) Target azimuth (14 bits)
- (c) Filter number (3 bits)
- (d) Target magnitude (16 bits)
- (e) PRI used
- (f) Weather threshold crossing messages
- (g) Status

The bit numbers shown above are minimal numbers (based in part on DABS requirements).

3.4.5.2 Major Functions of the MTD Processor.- Major functions of the MTD processor, as shown in Figs. 3.4.5-1 and 3.4.5.-2, are:

Data Memory	(3.4.5.3.3)
Saturation/Interface Test	(3.4.5.3.3)
Filters	(3.4.5.3.4)
Two-Pulse Canceller	(3.4.5.3.4.1)
Non-Zero-Velocity Filters	(3.4.5.3.5)
Zero-Velocity Filter	(3.4.5.3.6)
Approximate Magnituder	(3.4.5.3.7)
Adaptive Thresholding	(3.4.5.3.8)
Clutter Map	(3.4.5.3.9)
Zero-Velocity Filter Thresholding	(3.4.5.3.10)
Combined Thresholding	(3.4.5.3.11)
Fixed Thresholding	(3.4.5.3.12)
Weather Processing	(3.4.5.3.13)
MTD Processor On-Line Diagnostics	(3.4.5.3.14)
Filter Normalization	(3.4.5.3.15)

The detailed design requirements for the overall process and for each of these functions are specified in the following paragraphs.

3.4.5.3 MTD Processor Performance Requirements.-

3.4.5.3.1 Overall Performance.- Returns from a group of eight successive radar transmissions, i.e., a coherent processing interval (CPI), shall be stored and processed through a bank of eight digital filters. Each filter shall be designed to accept a band of doppler frequencies and to reject other doppler frequencies so as to enhance the detection of radar signals in clutter and weather background. The complex filter outputs shall be detected by means of a magnitude algorithm. Adaptive thresholds shall be generated for each filter. A target/no-target decision shall be made once per scan in each of eight doppler resolution cells for every range cell in each CPI. Radar echoes which cross a threshold shall cause the output interface to transmit to the C&I unit digital information including range, azimuth, amplitude, and doppler coordinates of the threshold that was crossed. No truncation or round-off shall be permitted in the arithmetic manipulations.

The performance of the MTD processor of the terminal ASR-MTD sub-system is critical to the overall high performance required of the radar system. This unit is required to process separately eight nearly orthogonal velocity filters, in each of at least 960 range intervals (1/16 nmi each), during each of at least 512 CPIs, during each scan of the radar antenna. A total of approximately 4×10^6 resolution cells must be processed during each scan

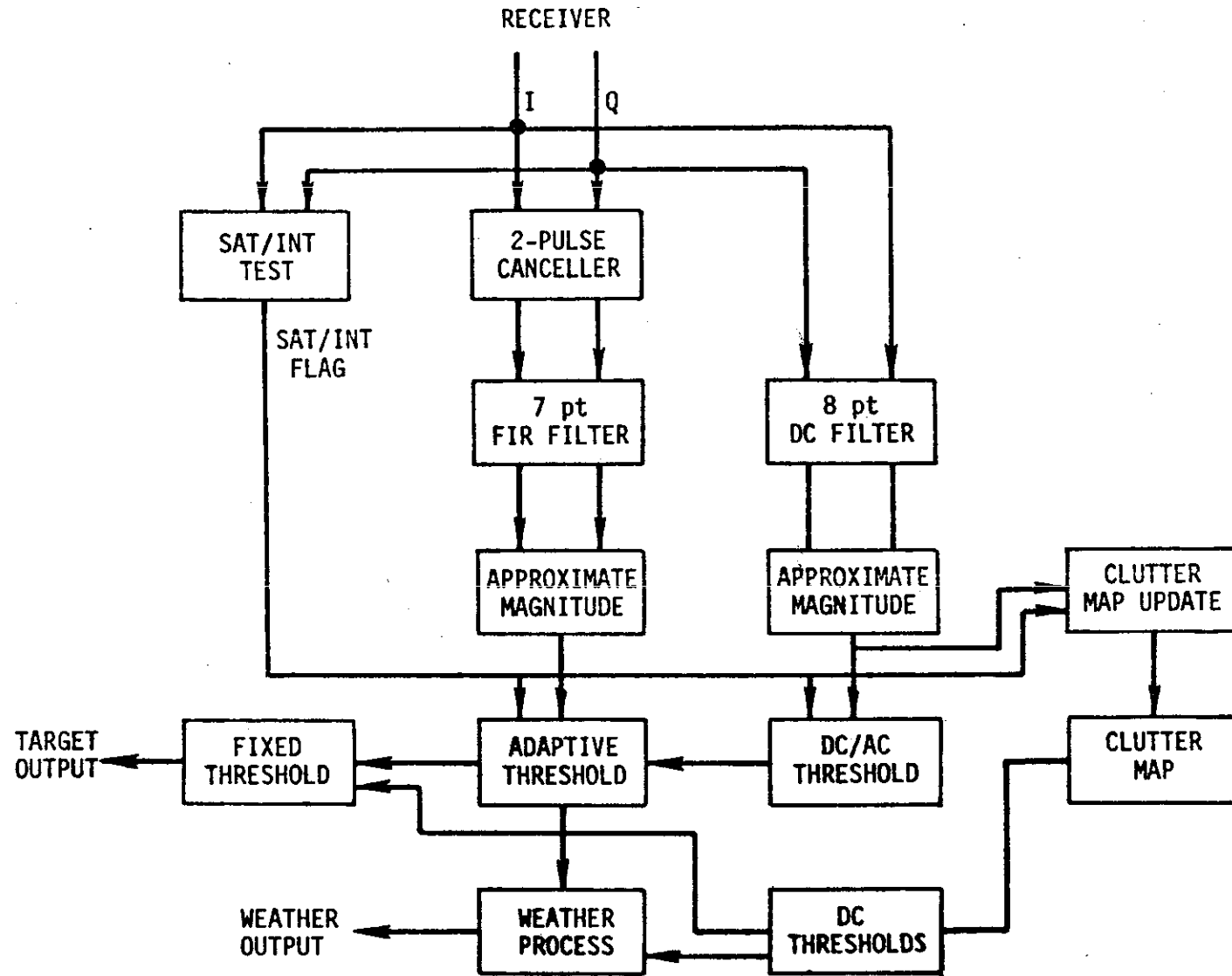

Figure 3.4.5-1 MTD Processor, Block Diagram

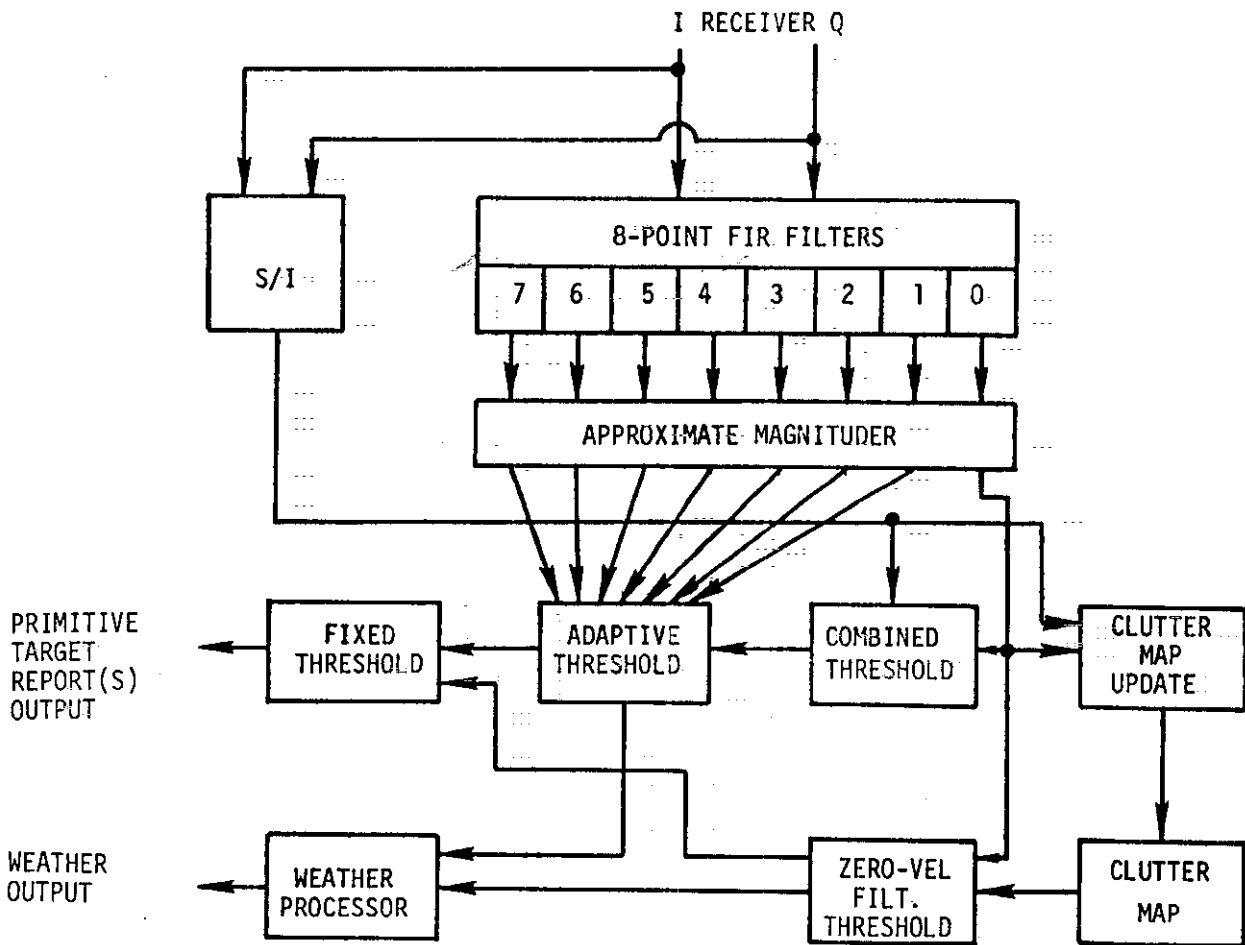

Figure 3.4.5-2 MTD Processor, Alternative, Block Diagram.

of the antenna (approximately 4 sec.). In addition, 60 each one-nmi contiguous range cells must be processed during alternate CPIs (256 per scan minimum) to determine if programmed levels of precipitation echo have been exceeded. The parameters of this processing unit, including filter coefficients are to be alterable by ROM option, on a radar site dependent basis, and the proposed unit architecture must provide this feature. A candidate/MTD parallel processing architecture is described in Appendix B, which can meet the performance requirements specified in this section, and is intended to serve as an example.

The MTD process, as described in the preceding paragraph and as implemented in the functional units whose design requirements are specified in the following paragraphs, shall exhibit the following overall performance characteristics:

- (a) The MTI improvement factor* shall be within 2 dB of that attainable with an optimum processor for 40 dB clutter with a spectrum that corresponds to the antenna scanning modulation. See Fig. 3.4.5-3.**
- (b) Dynamic range - The linear dynamic range of the system shall be determined by the number of bits in the analog-to-digital converter. No part of the processor shall restrict the linear dynamic range to values less than would be experienced if the system were completely linear with its dynamic range limited only by the A/D converters.
- (c) False alarms rates - When the receiver signal channel is passing only thermal noise and the COHO channel is operating normally, the false threshold crossing rate of any doppler output shall not increase by more than a factor of two when the rms noise level as measured at the A/D converters is decreased from 10 quanta to one quantum.

* MTD improvement factor is a power ratio defined as $I(f_d) = Y_o/Y_i$ where Y_o is the ratio of target power to interference residue power at the processor output, Y_i is the ratio of target power to interference power at the input to the processor and f_d is its target doppler offset frequency. The clutter spectrum is assumed to be centered at zero velocity.

** Modified by zero-velocity filter desensitization when used. See paragraph 3.4.5.3.11.

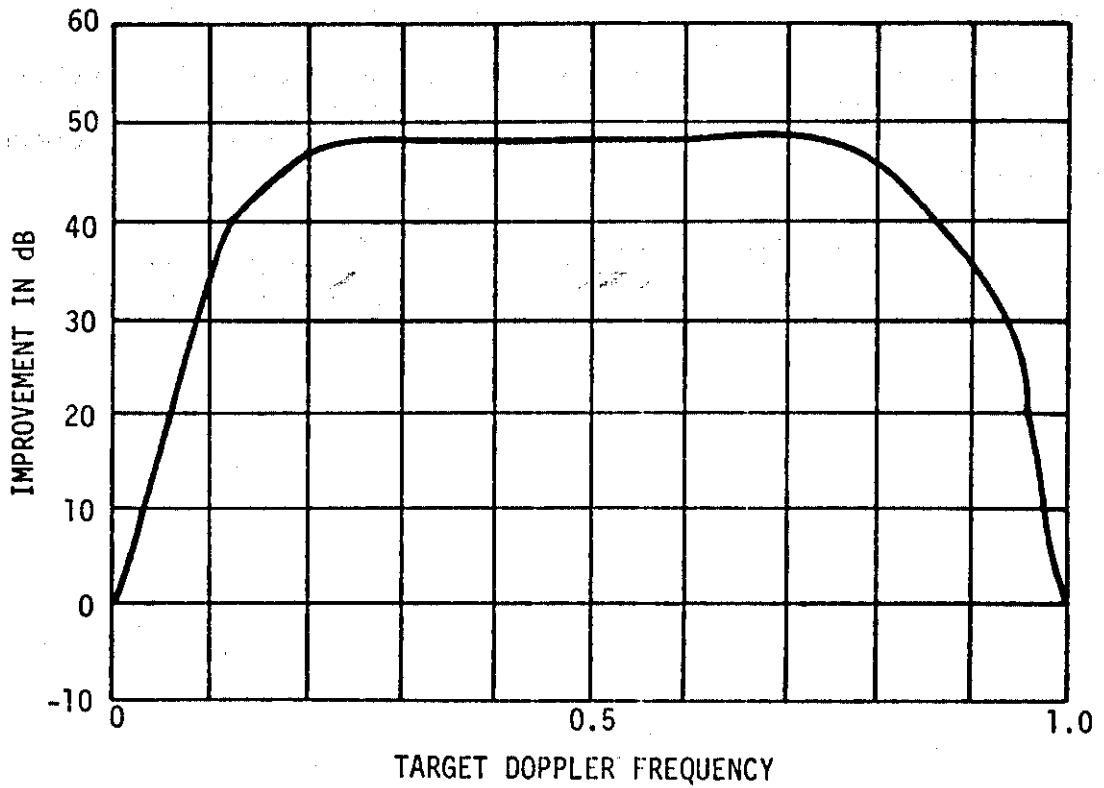

Figure 3.4.5-3 MTI Improvement Characteristic

- (d) When the receiver channel is passing only thermal noise at any given false alarm rate between 10^{-6} and 10^{-4} , the best obtainable sensitivity, using an RF test target generator, shall be within one (1) dB of the computed sensitivity when operating at the same false alarm rate. For this test, the test signal pulse may be centered on a range gate for minimum gate splitting loss and the doppler frequency may be centered in the passband of the most sensitive doppler filter.

3.4.5.3.2 Data Memory.- The digitized I&Q samples from all range gates shall be stored for eight interpulse periods (one CPI). To accomplish this, a mass memory system shall be provided with capacity of approximately 8000 words of 20 bits each. Two such memories may be used alternately so that data in one can be processed while the other is being filled with new data.

3.4.5.3.3 Saturation/Interference (S/I) Testing.-

3.4.5.3.3.1 Saturation Level Test.- If any of the I or Q video samples causes limiting to occur in the A/Ds (the A/D maximum count shall be a parameter, nominally the count produced by a 1.0 volt input signal), all data from that range gate shall be voided for that CPI during the current antenna scan. Accordingly any threshold crossings in that cell shall be inhibited, and the contribution of that cell to the adaptive threshold (described later) excluded from the sliding window average.

3.4.5.3.3.2 Interference Test.- The quantity $T = (K \sum_{j=1}^8 (|I(j)| + |Q(j)|))$ shall be calculated and then the $|I| + |Q|$ for each input $j=1$ point compared with T where K is a programmable constant (nominally set to 3/8). If T is exceeded by this value for any input point, it is presumed that it was the result of pulsed interference. Such a pulse would render all data from the gate suspect and all threshold crossings from that range/CPI cell are to be inhibited for that scan. The adaptive threshold shall not contain contributions from that cell.

3.4.5.3.4 Filters.- The MTD filters may be implemented by calculating eight separate eight-point FIR filters as shown in Fig. 3.4.5-2, or by calculating one eight-point FIR for the zero-velocity filter, and a two-pulse canceller followed by seven seven-point FIR filters for the non-zero-velocity domain, as shown in Fig. 3.4.5-1. The latter case reduces the precision requirements on filter weights, and is the basis of the detailed filter design specifications of this section. The filter weights for the eight-point FIR filter implementation are not given in this section (except for the zero-velocity filter), but can be derived by convolving the seven-point FIR weights with a two-pulse canceller to produce the eight-point filter weights. The filter shapes shown in this section are achievable using either approach.

3.4.5.3.4.1 Two-pulse Canceller.- The eight complex samples shall be input to a two-pulse canceller module, yielding seven complex samples which shall be passed to a seven-point FIR filter*.

3.4.5.3.5 Non-zero-velocity Filters.- The seven complex samples input to the FIR filter shall be multiplied by a set of seven complex weights and summed. Filter sidelobe levels shall be as shown in Fig. 3.4.5-4 for the seven filters. Table 3.4.5-A contains a set of filter weighting coefficients which yield the bandpass and sidelobe results shown in Fig. 3.4.5-4.

3.4.5.3.6 Zero-velocity Filter.- A separate 8-pulse filter shall be used for the zero-velocity case. The filter transfer function shall be as shown in Fig. 3.4.5-5, and the filter weighting coefficients which yield this result are listed in Table 3.4.5-B.

3.4.5.3.7 Approximate Magnitude.- For each filter output an approximate magnitude is calculated as $\text{Mag} = \max [63/64A + 1/4 B] [7/8 A + 1/2 B]$, where A is the larger of $|I|$ or $|Q|$, and B is the smaller.

3.4.5.3.8 Adaptive Thresholding.- For all non-zero filters a threshold shall be calculated which is the sum of eight range gates before and seven range gates after the point being thresholded, but with the two cells adjacent to the one of interest being subtracted from the sum. If either Saturation or Interference (S/I) was detected for any point(s) contributing to this sum, then these points shall not be used in the sum. This sum (13 cells) is multiplied by 3/8 to produce the "mean-level-threshold" (MLT) for the cell of interest. This is equivalent to dividing the sum by 13 to derive the mean, and then multiplying by 4.875 (threshold value equal to +13.8 dB for $P_{FA} = 10^{-5}$). If S/I was detected for the point being thresholded, thresholding shall be suppressed. The MLT for any range gate and any filter shall be equal to or greater than the peak quantization noise of the system. If a filter output magnitude value exceeds the computed threshold value, it shall then be subjected to further testing as described later in paras. 3.4.5.3.11 and 3.4.5.3.12.

3.4.5.3.8.1 Adaptive Thresholding for 1/16 nmi - 7/16 nmi Range Gates.- The estimates of ground clutter amplitude and scanning modulation residue in each range/azimuth/filter cell, in the range interval 1/16 nmi to 7/16 nmi (7 range cells, at least 512 CPI (azimuth) cells, and 8 filter cells) shall be kept in mass storage known as a residue map. The updating and use of the residue shall be as described in paragraphs 3.4.5.3.9 and 3.4.5.3.10. Adaptive "mean-level-threshold" (MLT) is not valid for these range gates, and the temporally smoothed residue map values shall be used instead. This unit shall permit processing of the range interval 1/16 nmi to 7/16 nmi where MLT values are not available.

*The use of the canceller reduces the precision requirements on the filter weights.

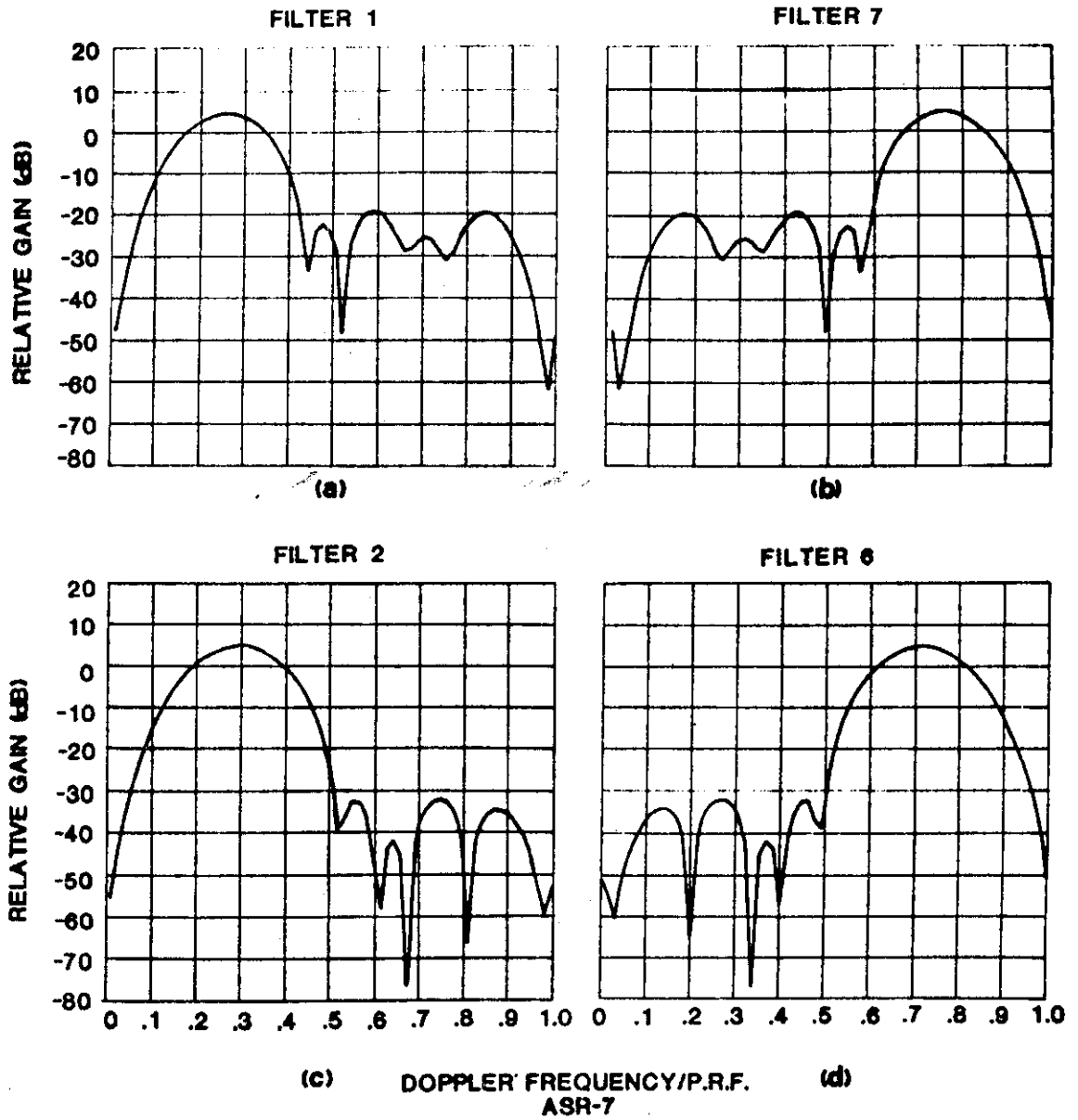

Figure 3.4.5-4A Non-Zero Velocity Filter Characteristics

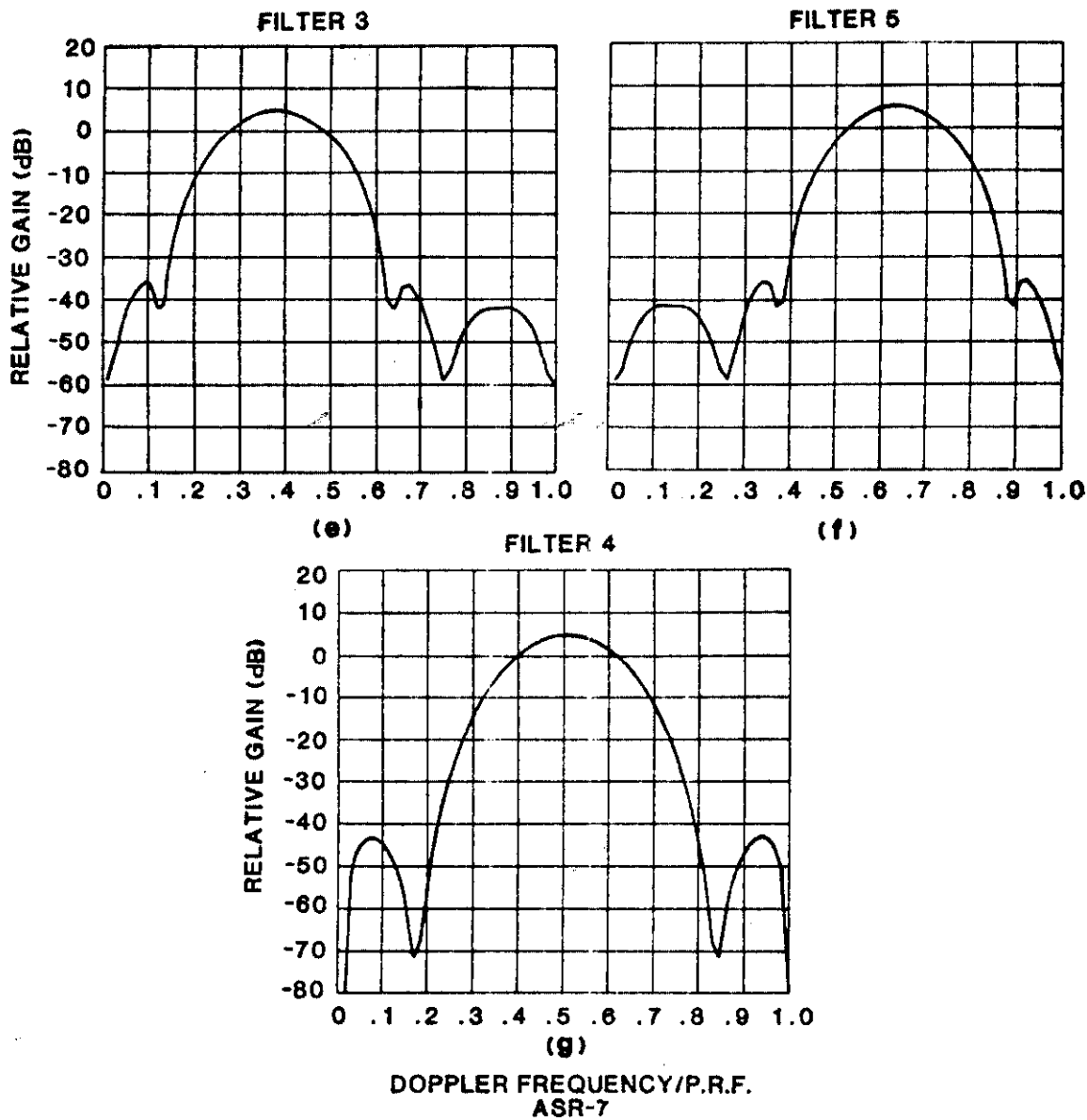

Figure 3.4.5-4B Non-Zero Velocity Filter Characteristics

TABLE 3.4.5-A

Filter Weighting Coefficients (for use with two-pulse canceller)

Filter 1		Filter 2		Filter 3		Filter 4		Filter 5		Filter 6		Filter 7	
<u>I</u>	<u>Q</u>	<u>I</u>	<u>Q</u>	<u>I</u>	<u>Q</u>	<u>I</u>	<u>Q</u>	<u>I</u>	<u>Q</u>	<u>I</u>	<u>Q</u>	<u>I</u>	<u>Q</u>
-3	-3	+2	-3	+1	0	+1	0	+1	0	+2	+3	-3	+3
+4	-7	+8	+6	-2	+3	-3	0	-2	-3	+8	-6	+4	+7
+11	+5	-12	+13	-2	-6	+6	0	-2	+6	-12	-13	+11	-5
-2	+15	-15	-15	+7	+3	-7	0	+7	-3	-15	+15	-2	-15
-12	+1	+13	-12	-6	+3	+6	0	-6	-3	+13	+12	-12	-1
-2	-8	+6	+8	+1	-4	-3	0	+1	+4	+6	-8	-2	+8
+4	-2	-3	+2	+1	+1	+1	0	+1	-1	-3	-2	+4	+2

TABLE 3.4.5-B

Zero-Velocity Filter Weighting Coefficients

I	-3	-1	+7	+15	+15	+7	-1	-3
Q	0	0	0	0	0	0	0	0

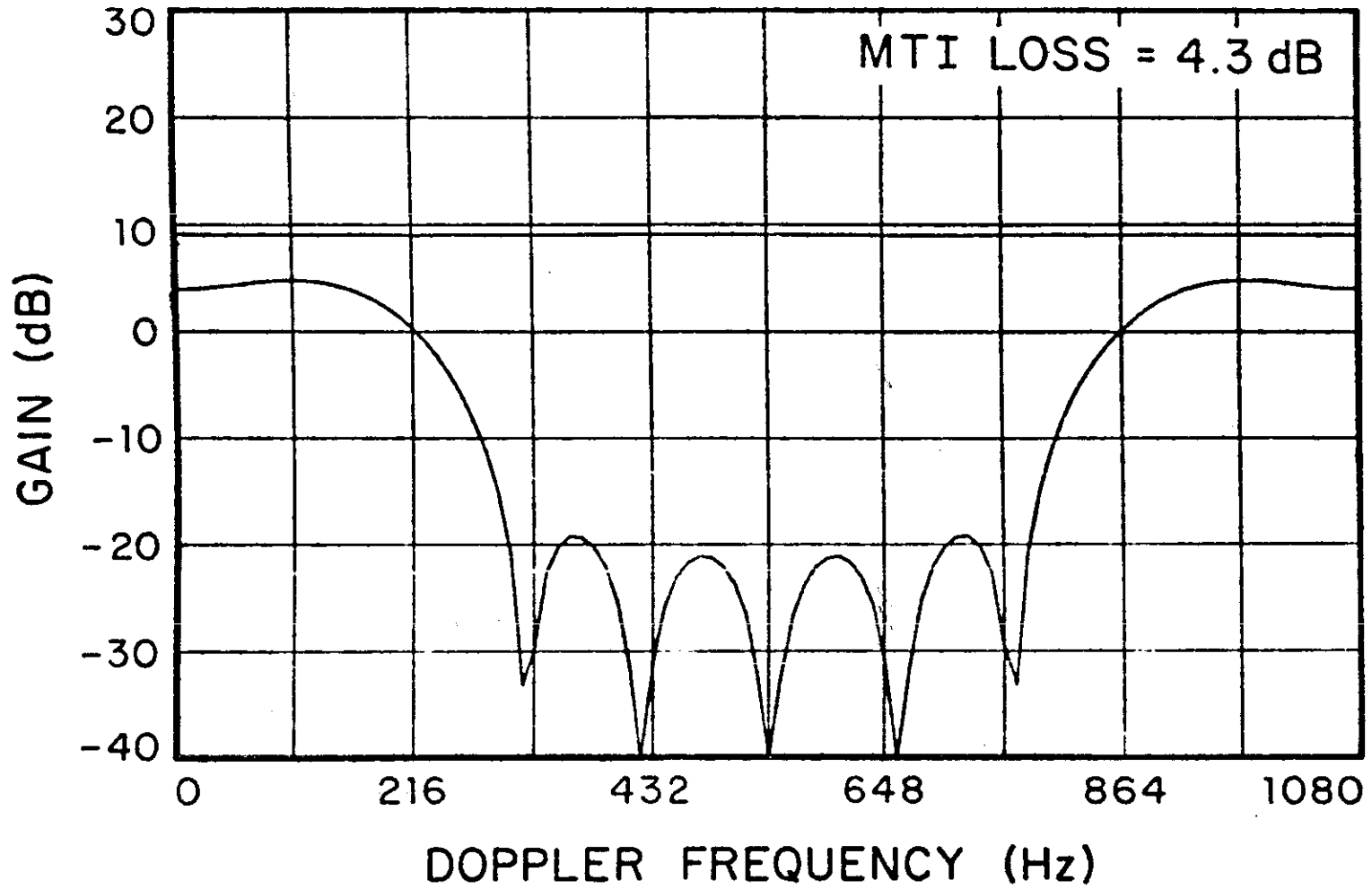

Figure 3.4.5-5 Zero Frequency Filter Characteristic

3.4.5.3.9 Clutter Map.- The estimates of ground clutter amplitude in each range/azimuth cell shall be kept in mass storage known as a clutter map. The map shall have a range resolution of one gate and an azimuth resolution of one CPI. As each value from the map is used for thresholding during the current scan, it shall be updated by adding 7/8 of the present map value to the present scan value and re-stored for use during the next scan. An ability to restrict the updating of the clutter map to any 2th scan ($n \leq 4$) shall be provided. If the S/I has been detected, the map shall not be changed. On powering-up or switching antenna polarization, the clutter map shall be set equal to a level equal to eight (8) times the receiver noise, and the declaration of zero-velocity target reports shall be suppressed for the next 16.n scan. Except when the standby channel is in the maintenance mode, the standby channel clutter map shall receive current data from the active channel, so that when the standby channel is switched to active status, the clutter map will contain up-to-date data, and zero-velocity targets can be declared immediately.

3.4.5.3.10 Zero-Velocity Filter Thresholding.- In order to threshold the zero doppler filter (SVF) output, it is necessary to use the clutter map which contains cells for each range-azimuth resolution cell of the radar. These values shall be represented as 8-bit floating point numbers (3-bit mantissa; 1-bit implied mantissa; 5-bit exponent)* Each magnitude value is compared to 5/8 of the value in the clutter map for thresholding with the same quantization noise limit and S/I requirements as above.

3.4.5.3.10.1 Zero-Velocity Filter Overload Limiting.- Since the clutter-map values are temporally smoothed over a minimum of 8 scans excessive numbers of zero-velocity target declarations can occur with the onset of interference. To prevent overloading subsequent processing, the rate of zero-velocity target declarations per CPI shall be limited to fewer than (8). If more than eight zero-velocity targets are declared during a CPI then all zero-velocity target reports shall be erased, and none transmitted to subsequent processing stages.

3.4.5.3.11 Combined Thresholding.- All non-zero-velocity filters shall be compared to a combined threshold which is the arithmetic sum of the adaptive threshold (MLT) and a fraction of the zero-velocity filter magnitude for the same range cell. Antenna scanning modulation residue in the presence of limiting ground clutter introduces noise into the non-zero-velocity filters, at levels equal to or greater than system noise, and can increase the rate of correlated false alarms. Combined thresholding shall be used to selectively desensitize those range/CPI cells containing "very high" clutter amplitudes. The amount of desensitization (fraction of the zero-velocity filter amplitude that is used) shall be separately adjustable for each filter. The range shall be 1/16 (-24 dB) to 1/256 (-48 dB) approximately in 3 dB steps. When the zero-velocity filter amplitude is below a programmable value (adjustable for each filter) for the filter/cell under test, the zero-velocity filter contribution to the threshold is set to zero and the MLT for this cell shall be used.

*The number of bits shown here represent minimal acceptable values to achieve the desired peak error of 12%.

3.4.5.3.11.1 Combined Thresholding 1/16 nmi to 7/16 nmi.- Gates in the range 1/16 nmi to 7/16 nmi shall be thresholded using residue-map values, since adaptive MLT values are not available.

3.4.5.3.12 Fixed Thresholding.- All primitive target amplitudes shall be compared to a fixed amplitude threshold. If the amplitude of the primitive target is equal to or greater than the fixed amplitude threshold and all other thresholds have been exceeded, then the primitive report shall be output to the C&I processor with the necessary data regarding doppler, azimuth, range, and magnitude; otherwise the target report shall not be used. This threshold level shall be adjustable by ROM option, and selectable by filter.

3.4.5.3.13 Weather Processing Module.- This unit shall be designed to detect the presence of precipitation clutter which exceeds two normalized, programmable amplitude levels, in either linear polarization or circular polarization. The unit shall detect threshold crossings in range/CPI cells by comparing averaged signal amplitudes against a table of range dependent stored values. Four range dependent tables shall be computed and stored; two for use when the system is operated in linear polarization (LP), and two for use when the system is operated in circular polarization (CP). The values used for CP may be scaled from the LP values by 1/4 (-12 dB). On alternate scans of the antenna, and during alternate CPIs compare the sum of the amplitudes of all filters, over a 16-range gate interval (1 nmi), and declare a threshold crossing if the sum is equal to or greater than the stored value, for one level of rainfall rate. This process shall be accomplished in 1/2 nmi range increments for additional smoothing. During the same scan and on the same CPIs compare the sum of the amplitudes of all non-zero-velocity filters against the same stored value. Declare a threshold crossing if the sum is equal to or greater than the stored value. Thus two range dependent streams of threshold crossings or zeroes are developed for alternate CPIs during this scan, indicating possible locations at which the rain rate exceeds the threshold level. This shall be repeated on the subsequent scan of the antenna for the other level of rainfall rate. These data are transferred to the C&I processor for temporal filtering, screening of false isolated threshold crossings, and for estimating contour intervals for both levels. The C&I unit will use a coarse clutter map to choose between the all filter thresholds (cells without high clutter values) and non-zero-velocity filter thresholds (cells containing high ground clutter values). The table values used (LP or CP) shall be selectable automatically when the antenna polarization is selected.

3.4.5.3.14 MTD Processor On-line Diagnostics.- The MTD processor shall be designed with excess range processing capability and timing margin, to allow processing of stationary and moving test targets introduced into the system either digitally for self-test or into the analog system front-end, for system test. Since the overall MTD processor is required to have a mean time between functional failure of 3000 hours, the processor as a unit must have a mean time between functional failure of 5000-6000 hours. There-fore, the MTD processor on-line diagnostic capability shall be limited in scope, shall indicate only major failures, and operate so as to introduce essentially no false alarms.

3.4.5.3.15 Filter Normalization.- The primitive target report strength (STR) shall be corrected to account for differences in filter gains. Each STR value shall be multiplied by a tabular constant depending on the filter number.

3.4.6 Correlation and Interpolation processor (C&I).- The C&I processor shall receive primitive target reports and weather contour data from the digital signal processor. Its principal function shall be to correlate, i.e., cluster, primitive target reports which are associated with a single, moving, aircraft target, and normalize their amplitudes by filter (velocity) and interpolate (estimate) foremost likely range, azimuth, velocity and amplitude. As the antenna scans by moving aircraft targets, a number of primitive target reports may be declared during each CPI and the target may be above threshold for as many as eight CPIs. Thus, large numbers of primitive target reports may be associated with a single moving target. The C&I processor shall develop a single target report for each separable cluster of primitive reports, and provide an estimate of range (1/32 nm), azimuth (1 ACP), velocity (filter to 1/64 of unambiguous interval) and normalized amplitude (STR). The target report shall also include the number of primitive target declarations associated with the report. The unit shall be micro-programmable and shall have certain parameters (e.g., censorable range-azimuth cells for moving ground traffic) selectable for each radar site. It shall develop adaptive amplitude thresholds to prevent system overload under conditions of severe "angel" activity. This unit shall format radar target reports for transmission to the surveillance processor and also to a co-located radar beacon correlator (DABS) when applicable.

3.4.6.1 C&I Processor Inputs and Outputs.- The inputs to the C&I processor shall be:

- (a) Primitive radar target reports,
- (b) Two-level weather threshold crossings

The output of the C&I processor shall consist of centroided radar target reports, output within 3/64 scan of passing the target azimuth position, and smoothed two-level weather contours. The C&I processor shall output on-line performance monitoring parameters to the maintenance display. The output reports shall contain the following information:

- (a) Target range (12 bits)
- (b) Target azimuth (14 bits)
- (c) Maximum amplitude filter number PRF-1 (4 bits)
- (d) Maximum amplitude filter number PRF-2 (4 bits)
- (e) Interpolated doppler PRF-1 (6 bits)
- (f) Interpolated doppler PRF-2 (6 bits)
- (g) Amplitude (12 bits)
- (h) Report quality (2 bits)
- (i) Total number of primitive reports last scan (12 bits)
- (j) Total number of radar reports last scan (10 bits)
- (k) Total number of radar reports last scan below σ_{tg} (10 bits)
- (l) Total number of radar reports last scan prior to 2nd adaptive threshold (10 bits)
- (m) Threshold used last scan (4 bits)
- (n) Moving test target status -
 - Range (1 bit)
 - Azimuth (1 bit)
 - Amplitude (1 bit)
 - Velocity (1 bit)
 - P_d (2 bits)

The number of bits indicated above are based on the DABS Engineering Requirement (ER) documents.

- (o) Two-level weather range/CPI contour point reports to DABS/ARTS as specified in FAA-ER-240-26A.
- (p) Two-level weather range/CPI contour point reports to the surveillance processor for transmission to the display processor. Note: These are internal to the MTD processing subsystem, and shall be internally consistent with data transfer requirements.

3.4.6.2 Major Functions of the C&I Processor.- Major functions of the C&I processor, as shown in Fig. 3.4.6-1, are:

Input data unpacking/buffering	(3.4.6.3.1)
Thresholding/Censoring map	(3.4.6.3.2)
Adaptive amplitude censoring	(3.4.6.3.3)
Correlating of primitive reports	(3.4.6.3.4)
Interpolating target reports	(3.4.6.3.5)
Second adaptive amplitude censoring	(3.4.6.3.6)
Target load/false alarm control	(3.4.6.3.7)
Two-level weather smoothing and contouring	(3.4.6.3.8)
Real-time monitoring	(3.4.6.3.9)
Output formatting	(3.4.6.3.10)

The detail design requirements for each of these functions are specified in the following paragraphs.

3.4.6.3 C&I Processor Performance Requirements.-

3.4.6.3.1 Input Data/Unpacking Buffering.- Input data unpacking/buffering shall receive packed data in suitable format from the MTD processor over a high-speed I/O channel. It shall unpack the primitive target reports and weather contour data and place these data in separate buffers for subsequent internal handling. The buffer capacity shall be large enough to allow the C&I processor to run up to 16 CPI's behind real-time when handling peak primitive target loads.

3.4.6.3.2 Thresholding/Censoring Map.- The threshold/censoring map shall be a site dependent thresholding/censoring screen to eliminate persistent correlated false alarms produced by moving ground traffic, and regions of limiting ground clutter. It shall contain a map of range/CPI cells with resolution of 1/4 nmi by 4-CPIs. The range and azimuth of each input primitive target report shall be used to look up a 3-bit number in the map. The 3-bit code from the map and the primitive target report maximum amplitude filter number shall be used (via a decoding table) to determine a threshold value for the primitive target. This is intended to implement a thresholding map with four (including 0) values of flat (in doppler) thresholds* and a shape the same as the antenna modulated clutter residues. This function shall serve as a geographic censor and selective software range/azimuth/gain control (RAG). Primitive target reports failing to pass the shaped doppler thresholds shall be eliminated; primitive target reports failing to pass the flat doppler thresholds shall be flagged as possibly moving ground traffic target reports and passed on.

*Analogous to target cross-section threshold.

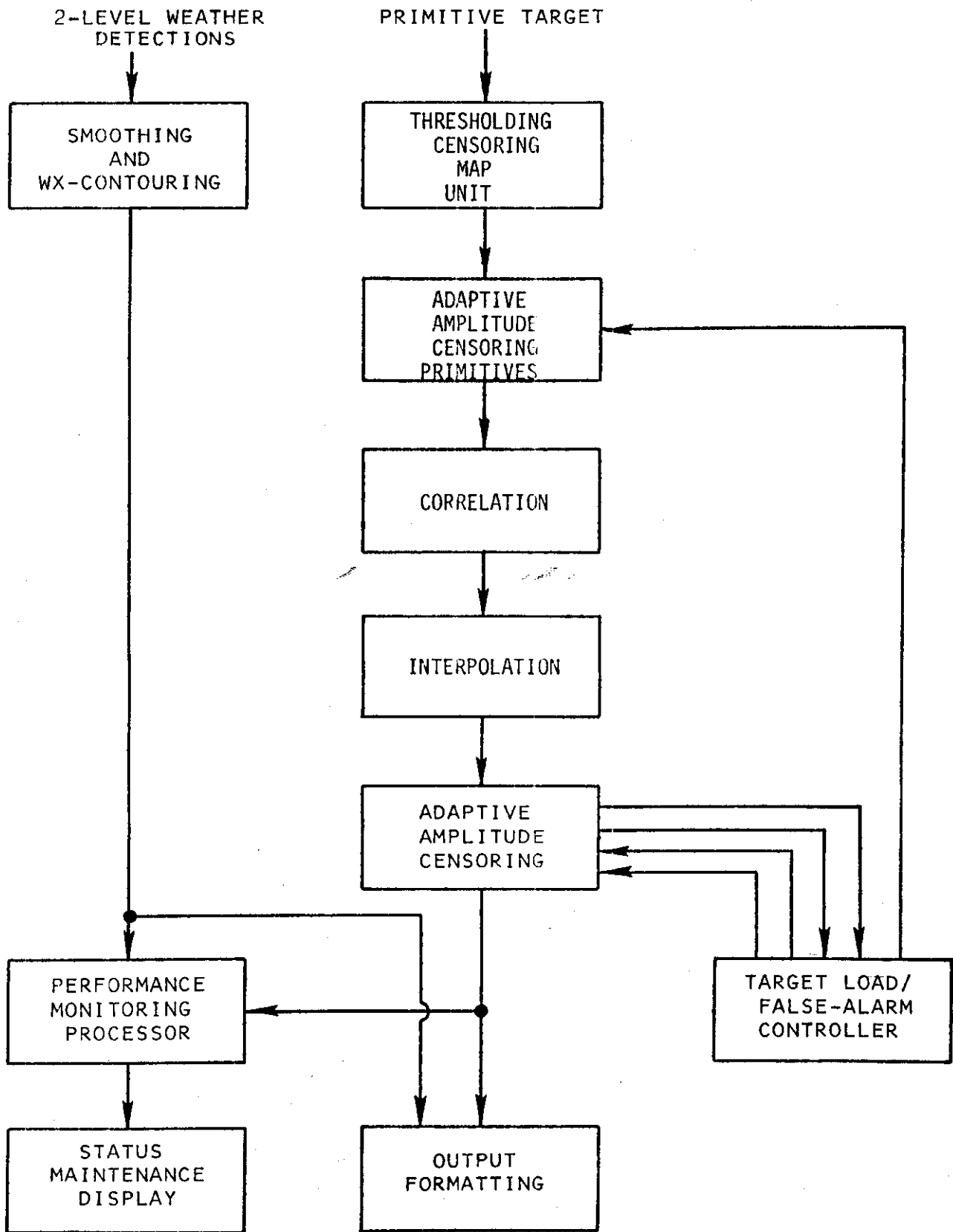

Figure 3.4.6-1 Correlation and Interpolation, Block Diagram

3.4.6.3.3 Adaptive Amplitude Censoring.- This function shall compare input primitive target report amplitudes against the pertinent global and fine grain adaptive amplitude thresholds which apply to the range/azimuth/filter number values of the report. The algorithms for developing the adaptive amplitude threshold values are described later in this section. Under normal operating conditions adaptive amplitude censoring shall not censor primitive target reports. Censoring of primitive target reports at this stage of C&I shall take place under conditions of extreme "angel" activity, and perform two functions: 1) reduce the primitive report load on the correlation/interpolation modules, and 2) prevent large numbers of angel false-alarms from associating with aircraft target clusters, and producing interpolation errors.

3.4.6.3.4 Correlating of Primitive Reports.- This function shall cluster (correlate) primitive target reports which are associated with the same moving target based on range and azimuth proximity. Clusters shall be formed as follows.

A single, isolated report which cannot be correlated with any of the existing clusters shall form the first entry in a cluster file. On succeeding correlation attempts a primitive shall be added to a cluster file if it is in or adjacent to the cluster in range and in or adjacent to the cluster in azimuth except that one CPI can be skipped in the azimuth case to allow for blind speeds. If the addition of the primitive report will result in the cluster becoming larger than the range and azimuth limits (3-range cells, 8-CPIs), then the new primitive report shall not be associated with this cluster. An attempt shall be made to correlate each primitive report in a particular CPI with each cluster. If the primitive has already correlated with one cluster and then correlates with another, the primitive report shall be incorporated into both clusters. After all primitive reports in a CPI are clustered, the clusters shall be examined to determine if any are completed. When two CPI's have been passed without adding a primitive report to a cluster, the cluster shall be closed. When a cluster is closed, it shall be passed to the centroiding unit for processing.

Primitive target reports flagged as possible moving ground traffic shall only be correlated with other reports with the same flag set. This flag shall be appended to the cluster when it is closed.

3.4.6.3.4.1 Elimination of RFI False Alarms.- This function shall eliminate single CPI clusters with $n(5 < n < 8)$ or more filter reports in a single range gate. Pulsed RFI occurring in a range gate containing large clutter/noise signals may not be detected by the interference test, and it shall be the function of this module to eliminate those clusters which are detected by this test. A means shall be provided to disable this feature.

3.4.6.3.5 Interpolating Target Reports.- This function shall develop estimate(s) of the centroids of clusters of primitive target reports, in range (1/32 nmi), azimuth (1 ACP), amplitude (1 A/D count) and velocity (1/64 of unambiguous interval).

Centroided ranges and azimuths shall be calculated for each cluster using a "center of mass" algorithm. The range centroid is given by:

$$\frac{\sum \text{amplitude}_i \times \text{range}_i}{\sum \text{amplitudes}}$$

and the azimuth centroid is given by:

$$\frac{\sum \text{amplitude}_i \times \text{azimuth}_i}{\sum \text{amplitudes}}$$

It will be necessary to adjust some primitive report azimuth values for the case in which a cluster straddles zero degrees azimuth, in order to produce a valid centroid.

The interpolating and target reporting unit shall append a "quality" factor to each centroided target report indicating the following:

	<u>Quality</u>
(a) One CPI Report	0
(b) Two CPI Reports different types	1
(c) Two or more CPI reports, same PRF	2
(d) Two or more CPI's each PRF	3

The maximum normalized amplitude in each of the filter groups 0, 1-7, 2-6 and 3-4-5, shall be determined and appended to the centroided target report.

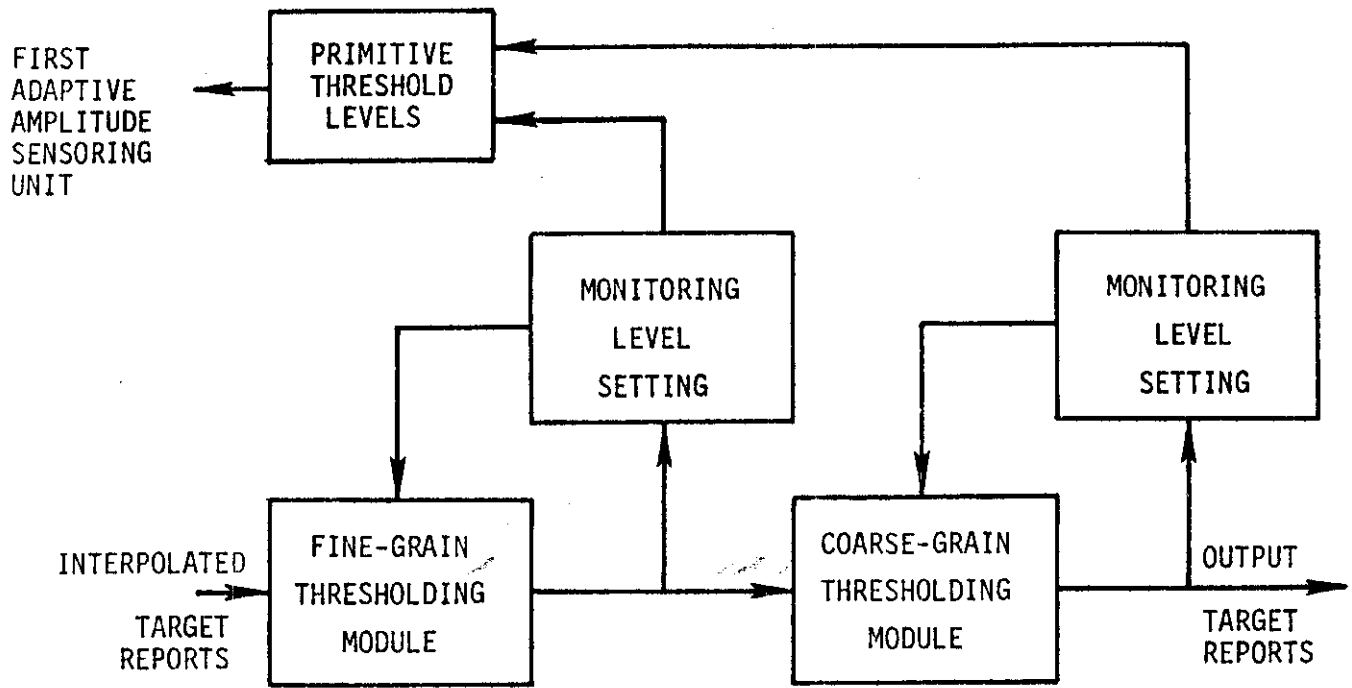

Figure 3.4.6-2 Target Report Amplitude Thresholding

3.4.6.3.6 Second Adaptive Amplitude Censoring.- This function shall compare input target report amplitudes against an adaptive (load/false alarm controller derived) amplitude threshold for the range, azimuth, applicable filter number. Target reports with amplitudes below this threshold for all respective filter groups shall be discarded. Target reports with at least one amplitude equal to or above one filter group threshold shall be passed to the output formatter, the performance monitor processor and to the target load/false alarm controller. At this point two target report confidence indicators shall be added to the report. The first indicates that a zero-velocity filter amplitude was required to enable this report to pass the applicable thresholds. The second indicates that this target report is the centroid of a cluster with a moving ground traffic flag. The first condition shall be indicated by the low order bit of the confidence field being set to zero (0). The second condition shall be indicated by setting the next to low order bit to zero (0).

3.4.6.3.7 Target Load/False Alarm Control.- This function shall develop adaptive amplitude threshold levels to control the rate of primitive target reports input to C&I, and to control the rate of false alarms to surveillance processing. The target report amplitude thresholding shall be implemented in the following two sequential modules:

(a) Fine grain threshold

Target reports shall be first thresholded against amplitudes set for 880 fine-grain cells in range, azimuth and filter space, covering the first 40 nm of radar coverage. The fine-grain cells shall be developed as follows:

4 filter groups 0 1,2 3,4,5 6,7

10 range bins 0-40 nm in 4 nm increments

4-40 azimuth bins dependent on range:

range	0-4 nm	4 azimuth bins per 360°
range	4-8 nm	8 azimuth bins per 360°
range	8-12 nm	12 azimuth bins per 360°
range	12-16 nm	16 azimuth bins per 360°
	.	
	.	
	.	
range	36-40 nm	40 azimuth bins per 360°

The threshold amplitudes for the zero velocity filter cells shall be calculated as follows: If i ($1 < i < 32$), or more, target reports pass the amplitude threshold test for the present scan, then increase the threshold by c -counts ($10 < c < 100$) for the next scan. If fewer than i target reports pass the amplitude threshold test for the present scan, then reduce the threshold by c/t ($10 < t < 40$), for the next scan. The maximum amplitude threshold value shall be limited to a count equivalent to +30 dB referred to system RMS noise. The threshold amplitudes for each of the other filter cells shall be calculated as follows: over an N scan ($20 < N < 200$) interval, a total count shall be kept of the number of target reports (at the output of this function) whose amplitudes are above and below a normalized amplitude which is equivalent to the computed cross-section (STC-corrected) for a STR ($-20 \text{ dBsm} < \text{STR} < 0 \text{ dBsm}$) target at the mean range of the cell, or an amplitude equivalent to +20 dB S/N (post-MTD processing), whichever is greater. At the end of each N -scan interval, the quantity $(N_{\text{small}} - N_{\text{large}}/8) - Q$; ($50 < Q < 500$) shall be calculated. If this quantity is equal to or greater than zero, the threshold for this cell shall be increased by p -dB ($2 < p < 10$). If the quantity is equal to or less than r ($-100 < r < 0$) the threshold for this cell shall be lowered by p -dB, otherwise it shall not be changed. The minimum amplitude threshold value shall be no lower than -3 dB, referred to post-processing system noise for any cell. Not all cells need to be updated on the same scan, and this processing load can be distributed in time. To be defined as small, a target must be detected in this group with a large enough amplitude to have passed all prior thresholds by itself, and have its maximum strength in all filter groups less than STR. To be defined as large, a target must have its maximum amplitude in this filter group greater than STR. Targets which are neither large nor small do not affect either N_{small} or N_{large} counts. For all cases, a target with a ground traffic flag set shall not affect either count.

(b) Coarse grain threshold

The second portion of target report amplitude thresholding shall be fast-acting, coarse-grain, using only two range-azimuth filter cells. This threshold shall be only based on, and applied to, targets at ranges equal to or less than 20 nm. This module is divided into two cells, one containing filters 0, 1, 2, 6, 7 and the other containing filters 3, 4, 5. To calculate these thresholds, the number of target reports larger than and smaller than (as described above) a normalized amplitude (equivalent to the computed cross-section (STC-corrected) STR, at the nearest 1 nm) passing this thresholding module, shall be summed over an m -scan period ($2 < m < 5$). The quantity $(N_{\text{small}} - N_{\text{large}}/8) - V$ ($50 < V < 500$) shall be calculated. If this quantity is equal to or greater than zero, the threshold shall be increased by q dB ($1 < q < 3$). If the quantity is equal to or less than ($-100 < V < 0$), the threshold shall be decreased by q dB, otherwise it shall be unchanged. The maximum amplitude threshold value for any cell is bounded by the value (parameter) selected for STR. The minimum amplitude threshold value shall be no lower than -3 dB, referred to post-processing system noise for any cell.

3.4.6.3.7.1 Target Report Threshold Level.- This function shall monitor the amplitude distribution of target reports output from the second adaptive amplitude censoring unit and shall develop amplitude threshold levels (azimuth, range, filter number) to control the rate of false alarms output from C&I to surveillance processing and radar/beacon correlation. Note that under normal operating conditions (refer to Fig. 3.4.6-3) without low amplitude "angel" false alarms, 90% of moving A/C target reports are above -10 dBsm (site dependent as a function of A/C type and traffic patterns).

3.4.6.3.7.2 Primitive Report Threshold Level.- This function shall develop the primitive target report amplitude threshold levels to be used in the first adaptive amplitude censoring unit described in para. 3.4.6.3.3. The thresholding levels for primitive targets shall be the maximum of the two applicable thresholds described above (fine-grain, coarse-grain) reduced by 10 dB.

3.4.6.3.8 Two-level Weather Smoothing and Contouring.- The weather data smoothing and contouring unit shall receive streams of range ordered threshold crossings for two levels of weather from the MTD processor. Using a site-dependent stored map (coarse, 1 nm resolution) this unit shall combine the all filter and all non-zero velocity filter threshold data into a new stream, on alternate scans of the antenna for each of two weather levels. Smoothing of the data to eliminate isolated threshold crossings (possibly due to large aircraft targets), and to eliminate isolated zeroes from contiguous streams of threshold crossings shall be effected as described in 3.4.6.3.8.1. Contour start and stop ranges shall be estimated on alternate scans for each of the two levels, and smoothed over a six scan interval, before updating a stored two-level contour map. This map is then output during the development of the next six scan map. The weather map output shall be three scans of light weather followed by three scans of heavy weather. The range/CPI for each contour boundary shall be formatted and transferred to the outputting unit for transfer to the surveillance processing unit, for subsequent output to the display processor.

3.4.6.3.8.1 Weather Data Smoothing.- This function shall develop a weather map containing 120 range cells (1/2 nmi granularity) and 256 CPI cells (Azimuth 1.4° granularity) for storing (over a 6 scan interval) weather data. Data shall be added to the map alternately over a 3-scan period, for each of the heavy and light weather thresholds (total 6 scans). The string of threshold-crossing bits are used to update the stored map as follows:

At a given range count (RC) and azimuth count (AC), if the bit is set to one (1) then one (1) is added into the map at these locations; (AC, RC), (AC+1, RC+1), (AC+1, RC), (AC+1, RC-1), (AC, RC+1), (AC, RC-1), (AC-1, RC), (AC-1, RC-1), and (AC-1, RC+1), except in these cases; if (RC-1)<1, or (RC+1)>120
If (AC-1)<1 then 256 is used
If (AC+1)>256 then 1 is used.

The cell counts will be in the range 0-27. When the count for a cell is equal to or greater than 12 at the end of the sixth scan (3 scans light weather and 3 scans heavy weather) smoothing period, this cell and the eight cells immediately surrounding it shall be declared as containing weather and shall be stored in the weather map.

3.4.6.3.9 Real-Time Monitoring.- This unit shall monitor the status of real-time data within the C&I processor. It shall accumulate, scale, format, and output data for display on the system status monitor. These data shall include, but not be limited to the following data during each scan of the antenna:

- a. Primitive target reports-total
- b. Primitive target reports filters 0-7
- c. Output target reports-total
- d. Output target reports-Quality 0-3
- e. Output target reports-Amplitude equivalent to greater than -10 dBsm
- f. First amplitude threshold value-(0,1,2,6,7)
- g. First amplitude threshold value-(3,4,5)
- h. Last scan number that any fine-grain threshold value was changed
- i. Present scan number
- j. Input buffer margin-pointer number
- k. Moving test target status-bit pattern
- l. Number of weather level-one contour points
- m. Number of weather level-two contour points
- n. Number of target reports output by range, in 10 nmi increments
- o. Number of error messages

3.4.6.3.10 Output Formatting.- This unit shall receive data from the second adaptive amplitude censoring unit and the weather contouring unit, and shall format these data for transmission to the surveillance processor, the status monitor, and to collocated radar/beacon correlation systems.

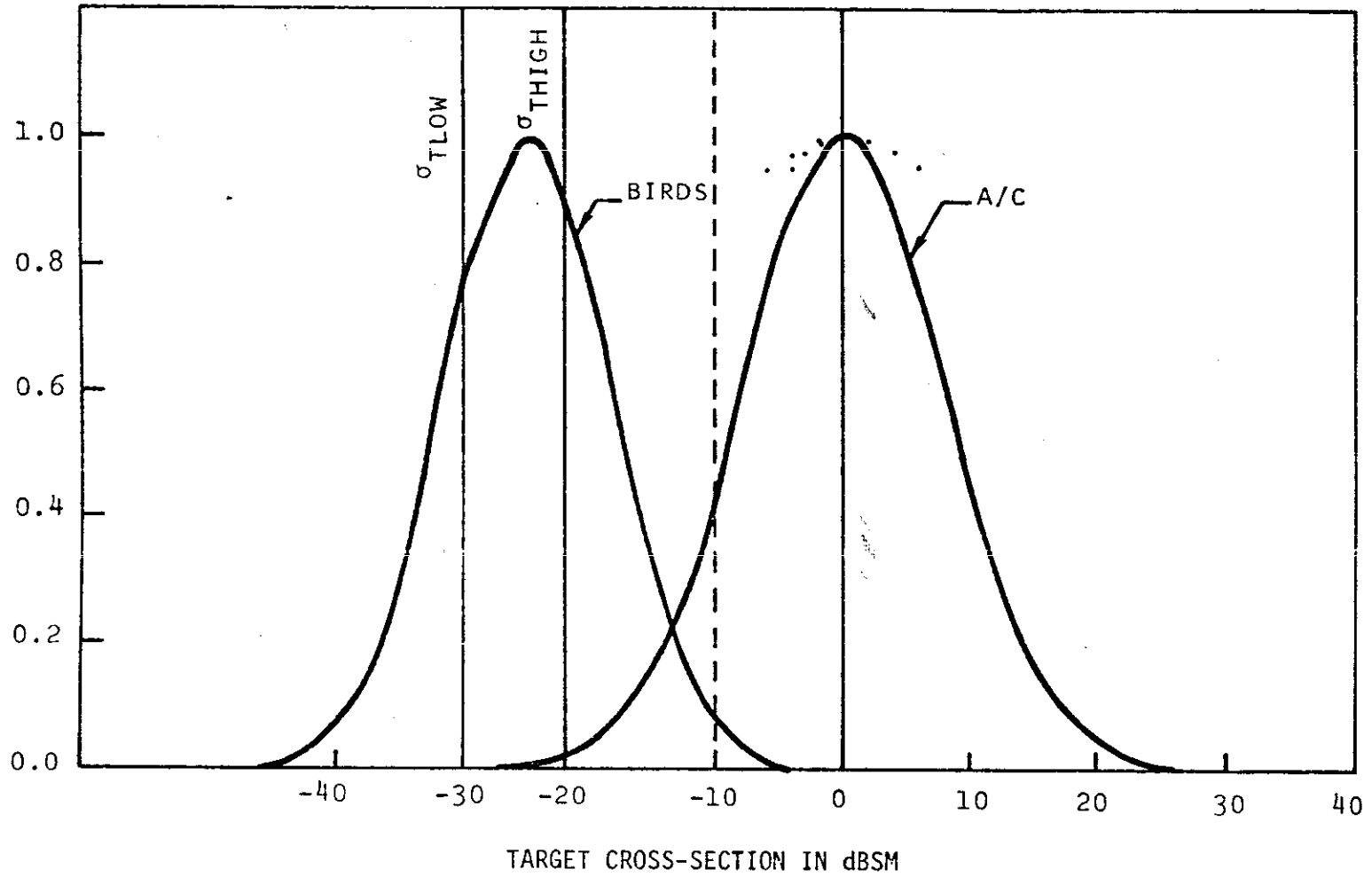

Figure 3.4.6-3 Target Cross Section Distributions

3.4.7 Surveillance Processor.- The surveillance processor shall receive radar target reports and two-level weather contours from the C&I processor. False target reports (not associated with moving A/C targets) shall be eliminated and displayable moving targets identified using scan-to-scan correlation. A/C target reports and two-level weather contours shall be output to the display processor.

3.4.7.1 Surveillance Processor Inputs and Outputs.- The inputs to the surveillance processor shall be:

- (a) radar target reports
- (b) two-level weather contours.

The outputs of the surveillance processor shall be:

- (a) radar target track reports
- (b) two-level weather contours
- (c) status of performance monitoring.

3.4.7.2 Major Processing Steps of the Surveillance Processor.- The major processing steps of the surveillance processor, as shown in Fig. 3.4.7-1, shall be:

- Target report-to-track association ("Association") (3.4.7.4.2)
- Resolution of target report-to-track association conflicts ("Correlation") (3.4.7.4.3)
- Updating track file parameters with new radar data, or setting coast parameters if no radar data is present during current scan. Drop track files that have been coasted for "too many" scans. ("Track Update") (3.4.7.4.4)
- Formatting and outputting of radar target reports which have correlated with displayable track files. Format and output 2-level weather contours. ("Outputting") (3.4.7.4.5)
- Testing to initiate new track files, using radar target reports not associated with existing track files. ("Track Initiation") (3.4.7.4.6)

3.4.7.3 Surveillance Processor Implementation.-

3.4.7.3.1 Surveillance Processor Implementation.- The MTD surveillance processor shall be implemented using a higher level language in a computer which supports a real-time operating system, responsive to the requirements of paragraph 3.0. The surveillance processing function will be subject to site-dependent parameter variations and should be implemented in a form that can support additions and deletions to operating algorithms, without affecting code modules not being changed.

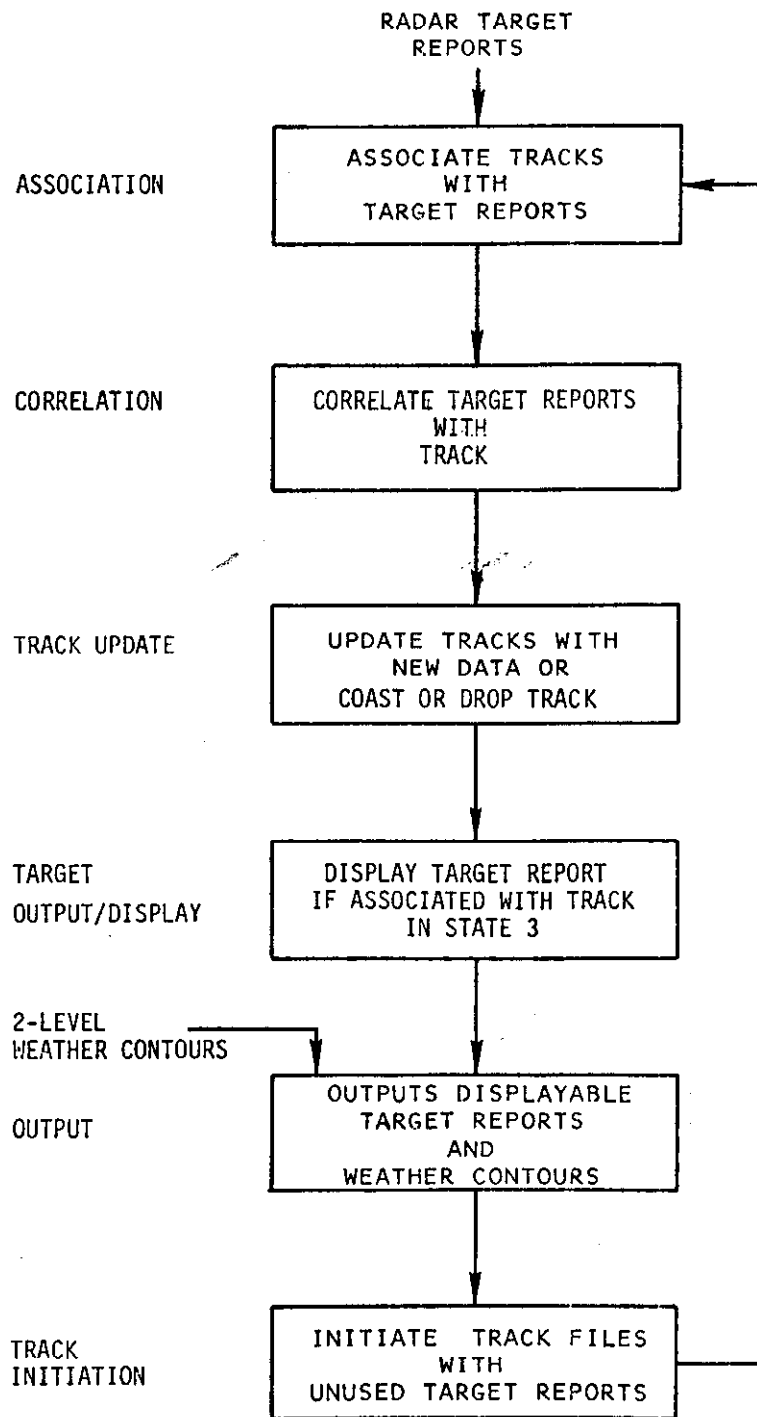

Figure 3.4.7-1 Surveillance Processor Block Diagram

3.4.7.4 Surveillance Processor Performance Requirements.-

3.4.7.4.1 Overall Performance.- The complete sequence of surveillance steps (para. 3.4.7.2) shall be performed 32 times per scan of the radar, i.e., radar data shall be collected in a buffer and the scan-to-scan correlation programs then sequentially process the data for the 11.25° sectors ($11.25^{\circ} \times 32 = 360^{\circ}$). Since aircraft cross sector boundaries at different stages of the processing, sector delays (a total of seven) relative to the sector for which radar data is currently being input to the scan-to-scan correlation must be handled.

A state diagram for the scan-to-scan correlator (surveillance processor) is shown in Fig. 3.4.7-2. The process proceeds as follows: Aircraft which are out of track are in state S_0 . Upon first detection, the track enters state S_1 . A small area is next established about the position of this first detection with dimensions δ_{ρ} and δ_{θ} equal to the distance a maximum velocity aircraft can travel plus an allowance for radar measurement error in the range and azimuth dimensions. If on the next scan a target is reported within this association area, the arrow marked "p" in Fig. 3.4.7-2 is followed to promote the track to state S_2 . If no target is reported within the association area, the arrow "q" is followed. As further detections occur, the track is promoted to higher states until it reaches the steady state.

If the track is in a higher state than S_1 , other values of δ_{ρ} and δ_{θ} will have been established in the track update process.

The transitions p' and q' represent targets that are followed by a track file which has not yet satisfied a minimum distance travelled requirement (see para. 3.4.7.4.1).

3.4.7.4.2 Target Report-to-Track Association.- An attempt shall be made to associate each input radar target report with one or more existing tracks. To qualify for association, a target report must be within specified range and azimuth windows surrounding the predicted position of the track during the current scan. These windows represent the range and azimuth prediction/measurement errors, and an allowance for target acceleration, since the last scan. The dimensions of these windows shall be a function of the range and state of the track as follow:

<u>Track State</u>	<u>Azimuth</u>	<u>Range</u>
S_1	\pm maximum target velocity, nominally 600 nmi/hour	\pm maximum target velocity, nominally 600 nmi/hour
S_2, S_3, S_7	\pm (14 ACP + 0.5g acceleration)*	\pm 4/32 nmi
S_4	\pm (14 ACP + 1.0g acceleration)*	\pm 7/32 nmi
S_5, S_6	\pm (20 ACP + 1.0g acceleration)*	\pm 7/32 nmi

* single-scan increase for acceleration.

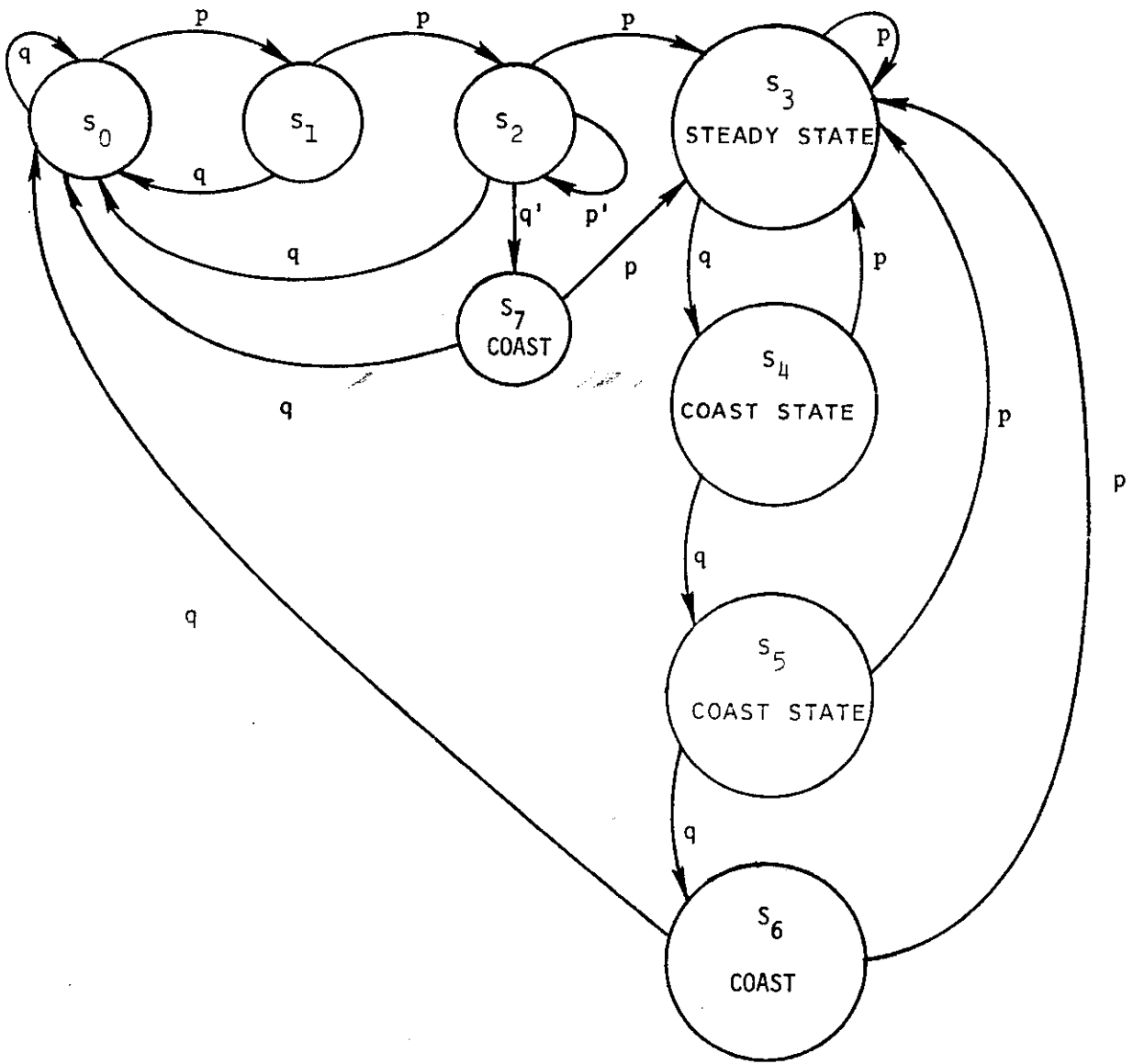

Figure 3.4.7-2 Scan-to-Scan Correlation State Diagram

Each input target report may associate with any track file that has not been updated within the previous one half scan, however, the search for associations may be limited to reasonable range and azimuth sectors to control the computational requirements of the association process.

3.4.7.4.3 Correlation.- The function of this module shall be to resolve target report-to-track file conflicts. Possibly non-unique target report-to-track file associations are resolved to provide a one-on-one, or zero-on-one correlation between target reports and track files. This process shall be delayed, so that new target reports received from late azimuths can be included in the search for associations. This task will be delayed a certain number of sectors (correlation shall be delayed approximately 7-sectors, at 11.25 degrees per sector), before resolving association(s) and outputting to update. For the case where only one target report was associated with the track file, and that target report was not associated with any other track file, the correlation is trivial, and the target/track update/display processing continues.

In the case where more than one target reports associate with the track, and at least one of the target reports is not associated with another track (or is not required for another track to have a target report associated with it), then the target report with the smallest association measure (defined below) which will not result in the loss of a target report-to-track association for another track, shall be correlated with the track.

$$\text{Association measure} = \left(\frac{\Delta\rho^2}{\delta\rho^2} + \frac{\Delta\theta^2}{\delta\theta^2} \right)^{\frac{1}{2}}$$

where: $\delta\rho$ and $\delta\theta$ are the range and azimuth windows for a track in State 2.

In the case where all of the associated target reports are necessary for another track to have an associated target report, then the target report correlated shall be the target report with the smallest association measure, and absolute preference shall be given to a target report associated with another track which is not in State 3. However, a target report shall not be correlated with a track when this will result in the loss of an association to another track, where the association measure for the other target report-to-track pair is smaller than the association measure for the track currently being correlated. This resolution shall be performed in order of decreasing track age.

3.4.7.4.3.1 Minimum Distance Requirement.- A track shall not be allowed to enter either State 3 or State 7 until it has either moved 1/4 nmi in range or 4 CPI's in azimuth. Target reports at ranges greater than 20 nmi are exempt from this requirement.

3.4.7.4.4 Track Update.- The correlation process has resulted in either zero or one target report being associated with a track file. The track file state is now updated according to the state diagram shown in Fig. 3.4.7-2. If the track file is not dropped (set to State-0, S_0) and has a correlated target report, it has its position updated as described below. Otherwise it is coasted using the same ρ , θ or x , y used on the previous scan (previous update).

When the range of the new target report is equal to or less than 8 nmi, a track file update shall be performed using a two-point interpolation in x, y , coordinates as follows:

x' = measured position this scan

x'' = measured position past scan

$\dot{x} = x' - x''$

$\dot{y} = y' - y''$

predicted $x = x' + \dot{x}$

predicted $y = y' + \dot{y}$

After the track file has been predicted ahead to the next scan, the position shall be converted back into ρ , θ coordinates.

When the range of the new target report is greater than 8 nmi., the prediction shall be done in ρ , θ coordinates, using α , β smoothing for the θ prediction.

smoothed $\dot{\theta} = \dot{\theta} + \beta(\theta' - \theta)$

predicted $\theta = \theta + \alpha(\theta' - \theta) + \dot{\theta}$

$\dot{\rho} = \rho' - \rho''$

predicted $\rho = \rho' + \dot{\rho}$

ρ', θ' = measured position present scan

ρ'' = measured position past scan

The values of α and β used in the process for smoothing θ are a function of the target report quality. The quality attribute is a function of the primitive target reports which contributed to the centroided azimuth of the target report on the current scan, and is set in the C&I processor. Target reports

with low quality (possibly large error in azimuth position measurement) are smoothed heavily, and target reports with higher quality ("better" measurement of the azimuth position) are smoothed less. The values of α , β to be used in predicting the track file position for the next scan are as follows:

<u>Quality</u>	<u>α</u>	<u>β</u>
3	1.0	0.9
2	1.0	0.9
1	0.9	0.7
0	0.6	0.3

3.4.7.4.5 Outputs.

3.4.7.4.5.1 Scan Correlated Targets.- All target reports which correlated with a track in State-3 (S_3) shall be formatted and output to the display processing unit via GFE MODEMS.

3.4.7.4.5.2 C and I Targets.- C and I targets shall be formatted and output to the display processing unit via GFE MODEMS.

3.4.7.4.5.3 Weather Contours.- Two-level weather contours shall be formatted and output to the display processing unit via GFE MODEMS.

3.4.7.4.6 Track Initiation.- All target reports which do not correlate with a track file are candidates for starting a new track. Quality zero, non-correlating, target reports at range less than R; ($0 \text{ nm} \leq R \leq 20 \text{ nm}$) and all low-confidence targets (either field) are discarded, i.e., set to State-0 (S_0), and all other non-correlating target reports become a track, State-1 (S_1).

3.4.8 Display Processor.- The display processor shall permit simultaneous display of MTD target video, MTD weather contour video, beacon video and map video on displays such as the ARTS or FAA Series-7300 PPI displays. The processor shall delay beacon and map video as necessary to account for MTD processing delays and to thereby cause proper overlay of the displayed radar, beacon and map video. Antenna position signals shall also be delayed for proper sweep rotation.

Two display processors are required in the ASR-MTD system, one located at the TRACON/TRACAB near the operational displays and a second at the radar site to drive the radar maintenance display. The processors are identical with the exception that the maintenance display processor does not process map video (it is not available at the radar site), and the TRACON display processor has a separate beacon signal delay circuit for each RADS console.

A candidate hardware implementation is described in Supplement B to Appendix A.

3.4.8.1 Display Processor Inputs and Outputs.- The inputs to each display processor shall be:

- (a) MTD target and weather video
- (b) Beacon video
- (c) Antenna ARP/ACP's
- (d) Timing Signals

At the radar site the target and weather video inputs shall be extracted directly from the surveillance processor. To provide the same information to the display processor located at the TRACON/TRACAB site these signals shall be forwarded in serial format over a synchronous data link. The necessary modems shall be provided.

The outputs of each display processor shall consist of:

- (a) Delayed MTD target video
- (b) Delayed weather video (TRACON/TRACAB site only)
- (c) Delayed beacon video
- (d) Delayed ARP/ACP's
- (e) Delayed triggers (as may be required)

At the radar site the above outputs are provided to the maintenance display; at the TRACON/TRACAB site these signals are forwarded to the video display system. Delayed ACP/ARP pulses are also sent to the video map unit.

3.4.8.2 Major Functions at the Display Processor.- Major functions of the display processor are:

- Beacon video delay (3.4.8.3.1)
- Sweep azimuth delay (3.4.8.3.2)
- MTD and weather video handling(3.4.8.3.3)

3.4.8.3 Display Processor Performance Requirements.-

3.4.8.3.1 Beacon Video Delay.- The beacon video delay unit shall consist of n identical delay sub-units operating under common control circuitry, where n is the number of RADS display consoles. Each sub-unit shall consist of a 1-bit quantizer and digital delay network capable of introducing an adjustable video delay of an integral number of radar sweeps. The delay introduced shall be adjustable in approximately 50-sweep increments to a maximum of 1500 sweeps, and shall be common to all sub-units. The precision with which the sweeps are delayed shall be at least one range-gate (1/16 nmi).

3.4.8.3.2 Sweep Rotation Delay.- The antenna position signals, ACP and ARP, shall be delayed by the same amount as the video signals. Delays introduced shall account for antenna rotation rate variations introduced by wind loading and mechanical imperfections. Time resolution and accuracy shall be one ACP interval.

An ACP/ARP-to-synchro converter capable of driving the FAA 7300-Series display systems shall be provided.

Delayed ACP/ARP signals shall also be provided to the video map unit, in order that map signals be delayed an amount equal to beacon video delay.

3.4.8.3.3 MTD and Weather Video Handler.- MTD radar target reports and zones of weather activity shall be transmitted from the radar site to the TRACON/TRACAB area via modems in serial format. The information transmitted shall consist of the following data:

- (a) Range of target or weather contour point, 1/16 nm resolution
- (b) Azimuth of weather contour point or initiation of target display arc, 1/4096 of 360° resolution
- (c) Arc length of target display, number of radar sweeps in which target blip is to be painted
- (d) Identifier (target, light weather or heavy weather), two bits

The video handler subsystem shall accept these messages and generate the proper signals for display so that beacon video, map video, weather video and targets may all be painted on the PPI scope at the proper range and azimuth.

Complete transfer of weather data from the MTD on a scan-to-scan basis shall not be required. Complete weather "map" data may be stored in the video handler and displayed for "n" scans (less than ten). During this time, an updated weather "map" shall be transmitted to the video handler subsystem by sending "one-nth" of a complete "map" each scan. When the new map has been completely sent, the old one shall be discarded, and the updated one shall be displayed for "n" scans while the regenerating process is repeated. The interior of each zone of light weather shall be shaded with a moderate brightness level on the PPI. The interior of each zone of heavy weather shall be shaded with a brighter level on the PPI. The four displayable video signals shall feed four separate video inputs on the PPI system, each with its own brightness control. The ratio of brightness between light and heavy weather presentation shall not be an operator adjustment.

3.4.9 Performance Monitoring.- A system of real-time performance monitoring shall be implemented so that the performance parameters of the system can be continuously measured. A method of accomplishing this is to have the processor that performs the C&I function schedule periodic moving test target signals input to the radar R/T. The C&I processor shall then analyze the resultant signal processor outputs to generate reports to the system maintenance/status display regarding the current system parameters. Among the tests that shall be included are a measurement of the detected signal amplitude, range, azimuth and interpolated velocity. When the standby channel is operating into dummy load, the false alarm rate shall be monitored, by filter.

*TRACON/TRACAB site only

3.4.9.1 System Maintenance Status Display.- A system status display will be implemented which will display the following information.

a. System Functional Status Summary - This display will indicate the state of the units of the dual-channel radar system (available, off, or in maintenance mode).

b. Detailed System Unit Status - This display will indicate the results of the measurements performed by the Performance Monitoring Subsystem.

3.4.9.2 Parameter Display.- This display will indicate certain parameters which relate to the current environment and traffic load. The parameters to be displayed shall be:

- a. Number of primitive targets in the previous scan by doppler filters and total.
- b. Number of centroided targets in the previous scan by 10-mi range increments and total.
- c. Number of active tracks/number of displayable tracks.
- d. Summary of the state of the second thresholds.
- e. A representation of the free processing time in the C&I and surveillance processors.
- f. Total number of weather threshold crossings for each of the two weather thresholds.

This display shall always display the system functional status summary, however the other information may either be displayed simultaneously or as a number of operator-selectable display frames.

3.4.10 Test Target Generator.- A test target generator shall be provided whose function is to provide a means of testing for correct operation of the entire MTD system from the RF input to the C&I output. The test target generator shall accept inputs for range, azimuth, doppler and amplitude from the C&I processor. Its output shall be an RF simulation of a target with the input parameters it would have if received by an antenna with a definable (e.g. set by ROM) antenna azimuth pattern. It shall be possible to operate the ASR-MTD system with the test target alone, hence provisions shall be made to operate using either antenna ACP's and ARP's, or simulated ACP's and ARP's provided by the system timing units.

SUPPLEMENT A TO APPENDIX A

A.1.0 Candidate MTD Processor Architecture.- This appendix provides a brief description of appropriate MTD processor architecture. An MTD processor employing this architecture was built and evaluated at Lincoln Laboratory. The parallel processing architecture was employed to achieve the necessary processing speed, functional modularity--permitting flexibility in modifying processing capacity, and on-line sharing of common processing modules. MTD processor performance requirements given in this specification can be met using this architecture.

A.2.0 Parallel Processor.- Fig. A-1. is a block diagram of the canonical parallel processor, consisting of a control module and several processing modules. A processing module was assigned to each 10-or-more mile segment (ring) of range coverage and each module type was composed of one or more printed circuit cards. All such cards were mounted in nests or baskets so that all connections could be made through connectors along one edge. The number of card types was held to an absolute minimum to facilitate servicing.

A.2.1 Processing modules.- Each of the several processing modules consisted of an arithmetic element, a toggled or "ping-pong" memory for storage of input data, and a bulk memory storage of ground clutter information. Each processing module was capable of performing all computations necessary to completely process a series of input data samples through thresholding. The implementation contained a spare processing unit automatically exchanged for any other processing module in the event a failure was indicated by the performance monitoring routine.

A.3.0 Controller.- The control module was microprogrammed so as to provide control signals to all the processing modules simultaneously so that they all could perform a given operation at the same time. The controller used a read-only memory (ROM) to hold the program instructions. The controller was responsible for the MTD processing as well as the on-line testing of the processing modules, the detection of a fault in one of these units, and the switching in of the spare unit. It also handled output message transmission.

A.4.0 Maintenance panel.- The signal processor cabinet contained a front panel with appropriate switches, lights and indicators to permit a field technician to diagnose faults to a particular plug-in card.

A.4.1 Controls and Adjustments.- All adjustments were part of the program firmware and thus did not appear on a front panel. Test target controls were accessible to the maintenance personnel without removing any circuit boards or powering down.

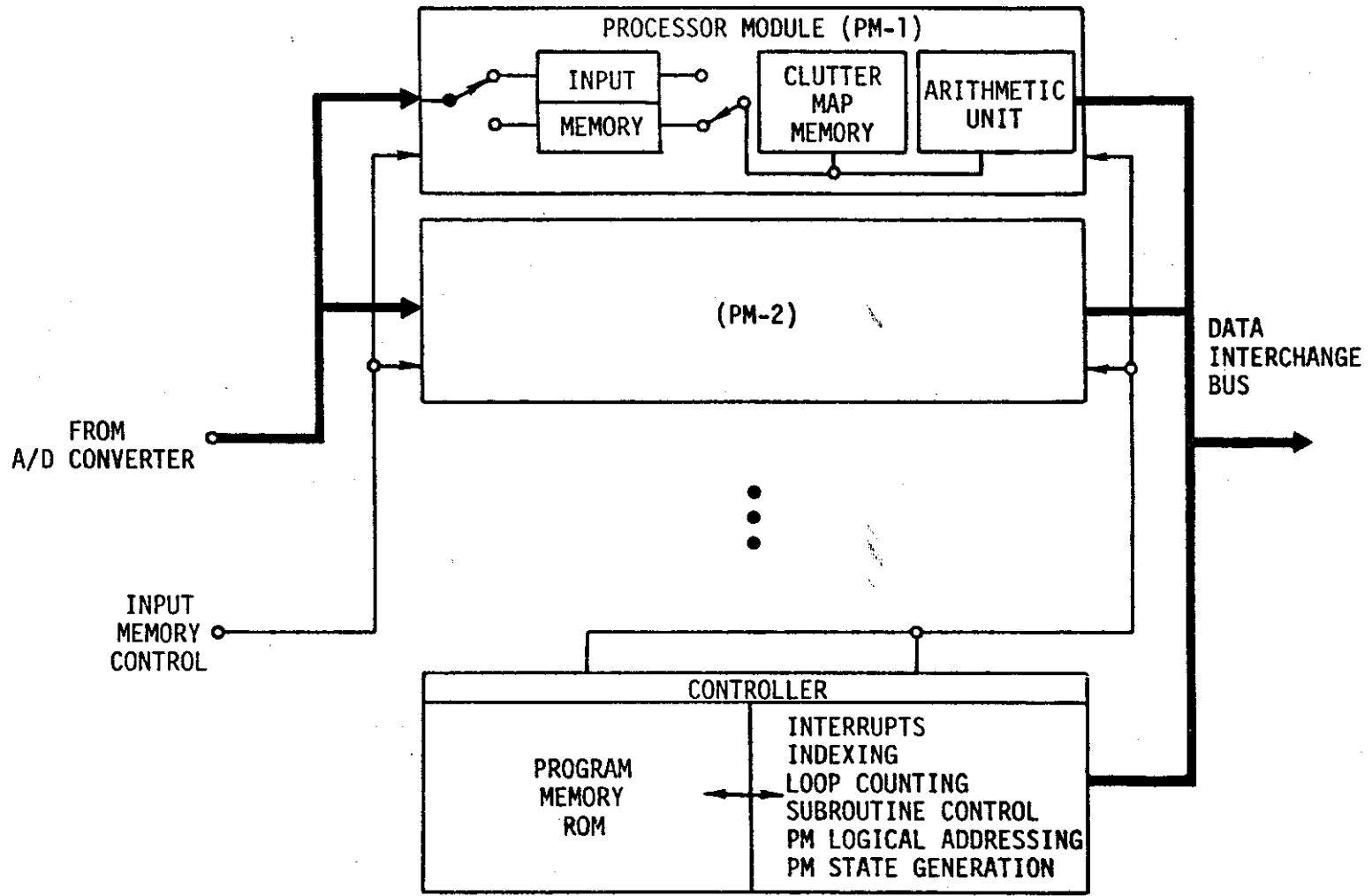

Figure A-1 Canonical Parallel Processor, Block Diagram

SUPPLEMENT B TO APPENDIX A

B.1.0 Candidate Display Processor.- A hardware implementation of the display processor specified in Section 3.4.8 is described, and a block diagram is shown in Fig. B-1.

B.2.0 Beacon Video Delay Unit.- Beacon video for each RADS is quantized by passing it through a thresholding circuit with adjustable bias. It is then passed through a delay line made up of up to thirty-two 16K dynamic memory chips organized as a shift register. Each chip represents 16 beacon sweeps of n range gates, where n is adjustable, but is usually set at 880 or 55 nmi. Since beacon sweeps only occur on each third radar sweep, each memory chip represents a delay of 48 radar sweeps, or approximately 50 milliseconds. The delay line may be "tapped" at the output of any chip, thus making a total of about 1.6 seconds tapped each 50 milliseconds. The output from the selected tap is passed through a line driver to one of the video input ports on the appropriate RADS PPI system.

B.3.0 ACP/ARP Delay Unit.- The ACP and ARP signals are each passed through identical digital delay lines. Only one will be described. The delay consists of five 4K static memory chips organized as a shift register of 20,480 stages. The shift clock rate is adjustable and is set to provide a total delay time identical to the video delay described above. For 1.5 seconds of delay, the clock frequency is about 14 KHz. The delayed ACP and ARP pulses are fed to line drivers and thence to the PPI sweep generators (or to synchro converters) and to the video map generator.

B.4.0 MTD Video Handler.- MTD data consists of messages forwarded in serial format over a synchronous data link. Each message describes a radar target or a weather contour point. Messages are received, decoded and formatted in a microcomputer. The range frame of the message is compared to a range gate counter and when they are equal, the message is entered into a first-in first-out (FIFO) register. By making this comparison, the messages are stored in the FIFO in ascending (correct) range order regardless of the order in which they are received from the MTD. Figure B-2. is a flow chart of operations in the video handler. Any or all operations can take place within one range gate time interval. At the start of each range time interval, the microcomputer output is examined to see if there is a message with a range frame equal to the range counter at that time, and if so, it is entered into the FIFO. Each message that arrives at the FIFO output is examined to see if its azimuth frame matches the output of an azimuth counter running on delayed ACP/ ARP signals. If there is a negative comparison, the message is reentered at the input of the FIFO. All messages in the FIFO are recirculated until it is time to display them on the PPI scope. If there is a favorable azimuth comparison, it indicates that the sweep rotation is in the correct position to display this target. The range frame is again compared with the range gate counter to see if the CRT beam is at the proper range to paint the target. When the range compares

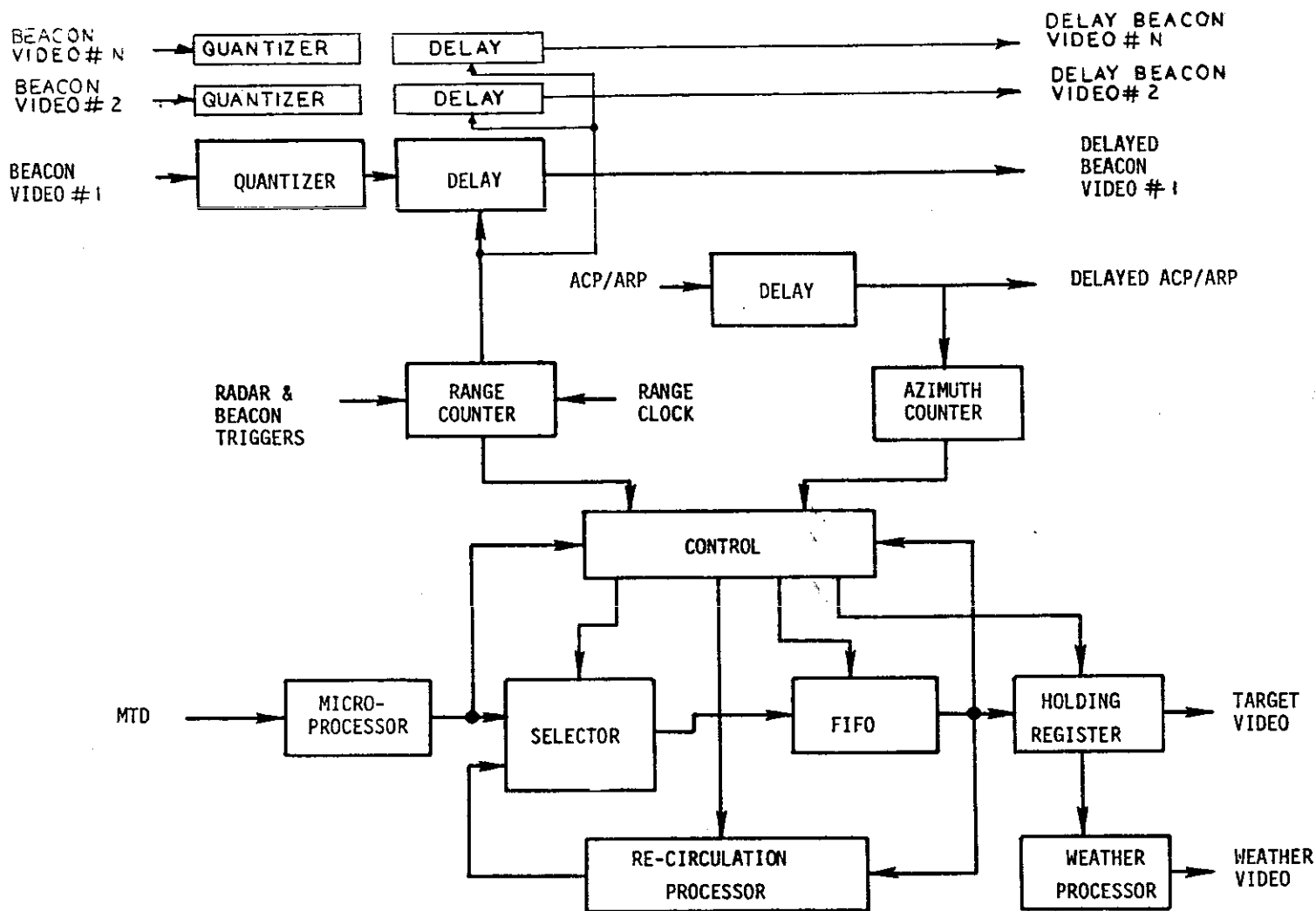

Figure B-1 Candidate Display Processor, Functional Block Diagram

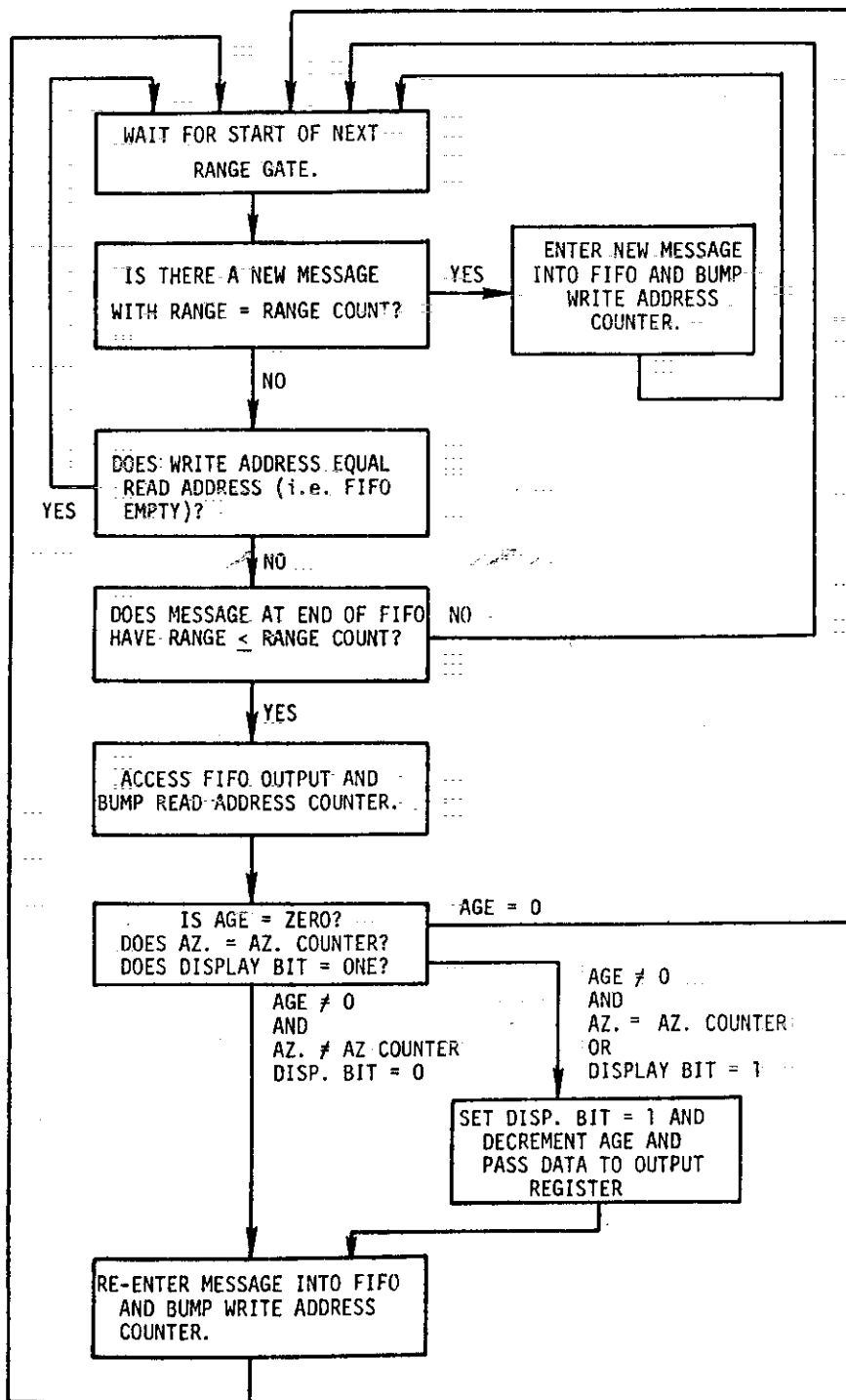

Figure B-2 Flow Chart Display Processor

favorably, a display control in the message is turned on, the arc-length frame is decremented the range and identifier frames are passed to a second holding register and the message is re-entered into the FIFO with the display bit turned on. On each succeeding sweep the range and identifier frames will be passed to the holding register and the arc-length will be decremented until such time as the arc-length has been reduced to zero. At that time, the message will not be re-entered into the FIFO and will be dropped from storage, as display of the target has been completed.

The holding register consists of another FIFO which holds data for one full sweep. If two targets overlay so that they would each require the same point to be painted, the redundant point is not entered into this register. Again, each message that appears at the output of this FIFO is compared to the range counter and held until a favorable compare is achieved. This FIFO causes all points to be displayed one sweep late, but this is not detrimental because one millisecond of sweep rotation is not resolvable on the PPI. When comparison is made, the identifier bits are examined. If a target is indicated, a 1/16 nmi pulse is sent to the MTD video input port on the PPI system to cause a dot to be brightened at the correct range and azimuth. If light or heavy weather is indicated, a pulse is sent to the weather processor.

The weather processor consists of two flip-flops and a combiner. The flip-flops are set to zero at the start of each display sweep. If a light weather point is decoded, the light weather flip-flop is set. A second point in the same sweep (representing the outer edge of the contour) causes the flop to be reset. Alternating points in the same sweep cause alternate sets and resets. Thus it may be considered that weather data points represent start and stop signals for weather zones. During the time that the flop is set, an intensify signal is sent to the combiner. If a heavy weather point is decoded, the other flip-flop is toggled in exactly the same way and a brighten intensify signal is sent to the combiner. Each weather message has an arc-length frame that causes the start and stop points to be displayed for 18 sweeps, the azimuthal resolution of the weather data from MTD. The combiner is an analog circuit which transmits three levels of video (dark, bright, brighter) to a weather video input port on the PPI system.

APPENDIX B

PMP/PM CORRELATION (CLUSTERING) AND INTERPOLATION

I. INTRODUCTION

A Clustering and Interpolation (C and I) algorithm was implemented on the parallel microprogrammable processor, PMP-2, for incorporation in the ASR-7 and FPS-67 radar systems at Burlington, Vermont and Bedford, Virginia, respectively. This Appendix describes the general organization of the program.

II. C AND I PROCESSING IN THE PARALLEL PROCESSOR

C and I processing involves grouping individual primitive target reports into clusters on the basis of spatial continuity, dividing each such completed cluster into subclusters, each representing a single target, and subsequently reporting a centroided range, azimuth, strength, and doppler for each of the subclusters. In the implementation described here, the cluster subdivision step is omitted: each cluster always gives rise to a single cluster report. Weather processing and performance monitoring, to be included in a future version, are also omitted.

The PMP-2, which performs the C and I processing, contains the following functional units: (1) a standard controller with 4096 words of program memory and 1024 words of 12 bits/word scratchpad memory (Xmem), (2) a single PE with the standard 1024-word, 24 bits/word scratchpad (PERAM), and (3) a type A2 auxiliary memory (Auxmem) containing 6-3/4 pages, at 4096 words/page, 24 bits/word. The Auxmem access time is nominally half a microsecond, but from the point of view of the program which must use separate instructions to disable and enable interrupts, transfer page and address information, and set up and initiate the data transfer, a more representative time is one microsecond per access. This value is used in timing estimates below.

A. Program Organization

The following general principles were followed in constructing the program:

1. All input primitives are placed in an input ring buffer.
2. With the exception of initial setup and interrupt handling, processing proceeds on a CPI basis. That is, with each iteration of the main processing loop, one CPI's worth of primitives are removed from the input ring buffer and are associated with existing clusters or are used to start new clusters; all clusters are then examined for conformity with a cluster-closing criterion and those meeting the criterion are closed to produce cluster reports which are transmitted to the tracker in a once-per-CPI IEEE bus message.

3. Each CPI's primitives are sorted by range before clustering. Also, all open clusters are retained in increasing range order.

4. All primitive information is present at cluster closing time.

The PMP-2 code to accomplish all C and I processing has been partitioned into eight steps, as follows.

STEP0. INITIALIZATION. Executed once immediately after PMP loading, this routine constitutes the coldstart procedure. It sets up values of constants, initializes values of some variables, and builds free storage chains in Xmem and Auxmem (see the description of storage layout below). It then transfers control to Step 2.

STEP1. I/O. This step is executed on an interrupt basis. It contains the routines for receiving primitive target reports from the signal processor and for transmitting cluster reports to the tracker via the IEEE bus. Received primitive targets are placed in a capacious ring buffer occupying Auxmem page zero. Transmitted cluster reports are pulled from a ping-pong buffer in PERAM, where they are deposited during execution of Step 7.

STEP2. AMPLITUDE NORMALIZATION and THRESHOLDING. This is the first step of the executed-once-per-CPI main processing loop. (The main processing loop consists of Steps 2 thru 7.) Containing a spin loop which is executed until the requisite data arrives in the input ring buffer, Step 2 extracts one CPI's worth of primitives, performs strength normalization and primitive amplitude thresholding, and writes the acceptable primitives into Auxmem page one in the format of a one-way linked chain.

Amplitude thresholding involves the use of sixteen tables of varying severity. One of the sixteen tables has been already chosen on the basis of performance monitoring; this table contains 16 thresholds which are applied to targets on the basis of range in 1-mile increments. Targets at a distance of greater than 16 miles are accepted without thresholding.

STEP3. SORTING. The chain of primitives output by Step 2 is sorted by range. The output of this step is thus a one-way linked chain of common-azimuth primitives in which the successor operation always leads to primitives of increasing remoteness from the radar.

STEP4. GEOGRAPHICAL CENSORING. The range and azimuth of each primitive in the chain sorted in Step 3 is compared against a list of clutter hot-spots retained in Auxmem page 6. Primitives found occupying undesirable areas are dropped from the chain. The hot-spot table is stored in gross order of increasing azimuth and in fine order of increasing range to render table searching efficient. (The entire table is thus traversed exactly once per antenna revolution.)

STEP5. ASSOCIATION. Each primitive from Step 4 either is added to an extant cluster or is used to initiate a new cluster. Because primitives are considered in order of range, and because clusters are retained in range order, this operation takes the overall form of a merge operation of the type encountered in sorting; the result is again a chain of clusters in range order. The precise format in which clusters are stored, chained to one another, and linked to the primitives they contain is described under storage layout below.

The precise rule for associating primitives with clusters is as follows: The range extent of a cluster is by definition the interval of ranges (RLO, RHI) where RLO is the minimum of the ranges of all primitives in the cluster and RHI is the corresponding maximum. In order for a primitive to associate with a cluster of range extent [RLO, RHI], the primitive's range must lie in the interval [RLO-1, RHI+1]. (The units for RLO and RHI are 'range counts', i.e., 1/16'ths of a mile.) If the primitive's range is exactly RLO-1 or RHI+1, the cluster range extent must be updated accordingly.

STEP6. COALESCING OF CLUSTERS. Due to the annexation of primitives in Step 5, neighboring clusters may grow to abut or overlap in range extent. Step 6 checks all neighboring pairs of clusters for this condition and coalesces to eliminate its occurrence.

STEP7. CLOSING. The criterion for closing of a cluster is that no primitive should have been added to the cluster during the current CPI or the previous CPI. Clusters meeting this criterion are subjected to the following operations to produce the following set of target statistics:

(a) Range. A plain amplitude-weighted centroid of component primitive's ranges is computed. Twelve bits (1/64 mile) of result are retained.

(b) Azimuth. Again, an amplitude-weighted centroid of component primitive's azimuths is computed to 12 bits (one ACP unit).

(c) Strength. Two strengths are computed: the maximum of all strengths of nonzero doppler primitives, and the maximum of strengths of all primitives, period. These results are called SNZ and SALL respectively.

(d) Doppler. Two doppler quantities are retained: the doppler number of the PRF #0 primitive of maximal strength, and the doppler number of the PRF #1 primitive of maximal strength.

(e) Quality. Letting N_0 denote the number of PRF #0 primitives in the cluster and similarly for N_1 , then $Quality = \min(2, N_0) + \min(2, N_1)$.

(f) Confidence. A threshold is accessed on the basis of interpolated range, truncated to miles. If $SALL < threshold$, the cluster is rejected. If $SNZ < threshold < SALL$, then confidence is set to 0. If $threshold < SNZ$, then confidence is set to 1.

Additionally, cellcount (= number of distinct range-azimuth cells spanned by the cluster) is tallied and used in interference-censoring: the cluster is rejected if cellcount = 2 and all nonzero dopplers are present, or if cellcount = 1 and all but (possibly) one nonzero dopplers are present.

The centroided range (12 bits), centroided azimuth (12 bits), SNZ (12 bits), SALL (12 bits), PRI #0 doppler (3 bits), PRI #1 doppler (3 bits), quality (3 bits), and confidence (1 bit) figures are placed in a 9-byte output report. At the conclusion of Step 7, events are initiated leading to assertion of SRQ on the IEEE bus, so the combined cluster report may be transmitted to the tracker. such a cluster message is sent every CPI, even when no clusters close.

Step 7 concludes with an unconditional branch to Step 2 for the next CPI's to be processed.

B. Description of Storage layout

The fundamental maxim of C and I storage layout is this: Primitive information occupies Auxmem; cluster information (aside from the information lying in the cluster's primitives) resides in Xmem.

The primitive input ring buffer (filled during execution of Step 1 and emptied during Step 2) occupies the 4096-word zero page of Auxmem. Each primitive occupies 2 words and each CPI requires a 2-word header. Thus there is space for 40 CPI's worth of data, at 50 primitives per CPI.

The primitive blocks built in Step 2 and manipulated in Steps 3 thru 7 occupy page 1 of Auxmem. Each primitive block occupies four consecutive words. Thus there is room for 1024 primitives in the process of entering or already within open clusters.

Pages 2, 3, 4, and 5 of Auxmem are unused.

Page 6 of Auxmem (the 3K page) contains the sixteen 16-word amplitude threshold tables used for primitive thresholding (Step 2) and cluster thresholding (Step 7) and also contains the clutter hot-spot table utilized in geographical censoring (Step 4).

Each cluster summary block occupies eight words of Xmem. There is one such summary block for each open cluster, and there is provision for 75 such blocks. Each block contains a pointer to the next such block and also pointers to the beginning and end of the chain of primitives within the cluster. In addition, the summary block contains indicators of the overall range and azimuth extent of the cluster and a count of the total number of primitives currently in the cluster.

Because primitives are not dismissed in the same order they arrive, and because clusters are not closed in the same order they open, a means for free (empty, unused) storage bookkeeping is required. Since each primitive and each cluster involves a fixed size block, this can be accomplished in a straightforward fashion by simply stringing all free blocks together in a one-way chain. Newly freed storage is annexed to the end of the chain; newly allocated storage is taken from the beginning. Thus the free storage pool acts like a ring buffer (rather than a stack), which is advantageous for program post-mortem analysis (since freed blocks remain untouched for a maximal length of time before being overwritten). There is one such free storage pool for primitive blocks in Auxmem page 1 and another for cluster summary blocks in Xmem.

Steps 0 thru 7 occupy approximately 1700 (decimal) words of PMP program memory. The standard PMP-2 loader/dumper/IEEE driver package occupies another 1000 words.

C. Calculation of Centroids

All computations involved in range and azimuth centroiding are performed in fixed-point arithmetic.

Range centroiding proceeds as follows: the minimum range of all primitives in the cluster (RGLOJ) is subtracted from each individual primitive's range (RGI) to produce a set of individual delta-ranges are weighted. Note that only four bits of delta-range are retained. Delta-ranges are weighted to yield SUMWRG as shown. SUMWRG is divided by SUMW to yield a 6-bit quotient RGQUOT. RGQUOT is the centroid of the delta-ranges, so adding back RGLOJ, appropriately shifted, yields RGCENT, the reported 12-bit centroided range.

A similar process is followed for azimuth. The main differences are that seven, rather than four, bits of delta-azimuth are retained, and that the final addition of AZQUOT to the minimum azimuth (AZLOJ) is performed modulo 360 degrees. The extra bits of delta-azimuth give rise to three extra bits of weighted azimuth counts (WAZI and SUMWAZ). These bottom three bits of weighted azimuth are dropped. This could imply a problem for very low-strength interpolations; rounding or bit re-alignment may be required.

The above centroiding algorithm is secure against computational overflow in dealing with clusters of range extent less than 1 mile (16 range counts),

of azimuth extent less than 16 CPT's (128 ACP's), and of number of subsumed primitives less than 64. The most lsb-critical quantities in the calculation are SUMWRG (sum of weighted delta-ranges) which is retained to one normalized strength*range count, and SUMWAZ (sum of weighted delta-azimuths) which is retained to one normalized strength*CPI count. At present the program contains no checks for 'oversize' clusters.

D. Description of Sort Algorithms

Sorting is performed using the standard IBM card-sorter algorithm. This algorithm sorts records on a k-digit key by sorting them first on the least significant digit, then on the next more significant digit, ..., and finally on the most significant digit of the key. (Sorting on the l'th digit 'd' involves extracting, without permutation, all records having d = 0, following these with all records having d = 1, ..., following these with all records having d = h, where h is the highest possible value for d. See Knuth, Volume 3, Section 5.2.5.) As employed in C and I Step 7, ten passes are made over the current CPI's data, with each pass involving a sort on a single binary digit of range. This algorithm requires 0.1 ms to sort 0 targets and about 1.75 ms to sort 50, and the timing is linear in the number of targets. The time could be cut roughly in half by considering range as a 5-digit base-4 quantity instead of a 10-digit base-2 quantity. This change could be incorporated in a future version if run-time becomes more critical.

E. Execution Time and IEEE Bus Time Per CPI

The following table gives the worst-case run-time requirement for each step of the program as it currently exists. With the exception of Step 1, the figures are based on actual instruction counts together with the assumption of 50 input primitives and 50 closing clusters per CPI and several other worst-case assumptions.

Step 1:	1.40 ms.
Step 2:	0.60 ms.
Step 3:	1.75 ms.
Step 4:	0.25 ms.
Step 5:	0.35 ms.
Step 6:	0.55 ms.
Step 7:	1.75 ms.
Total:	6.65 ms.

The maximum interrupt disable time in Steps 2-7 is approximately one microsecond, the time of an Auxmem access. Thus assuming 256 bytes apiece in the primitive and cluster messages, the IEEE bus time occupied by their transmission is given by 1.9 ms (the Step 1 time plus 0.5 ms).

APPENDIX C

LIST OF ASR-MTD ACRONYMS AND ABBREVIATIONS

A/C	Aircraft
ACP	Azimuth Change Pulse
A/D	Analog-to-Digital
ARP	Azimuth Reference Pulse
ARTS	Automated Terminal Radar System
ASR	Airport Surveillance Radar
ATC	Air Traffic Control
BTV	Burlington, Vermont
BVA	Bedford, Virginia
C&I	Correlation and Interpolation
CD	Common Digitizer
CFAR	Constant False Alarm Rate
CP	Circular Polarization
CPI	Coherent Processing Interval
DABS	Discrete Address Beacon System
dBsm	Decibels with respect to 1.0 sq. meter
dBz	Decibels with respect to radar reflectivity factor, z.
ER	Engineering Requirement
FAATC	Federal Aviation Administration Technical Center, Atlantic City, NJ
FFT	Fast Fourier Transform
FIR	Finite Impulse Response
IF	Intermediate Frequency
I/F	Interface
I&Q	In-phase and Quadrature-phase
LP	Linear Polarization
MLT	Mean Level Threshold
MTBF	Mean Time Between Failure
MTD	Moving Target Detect(or)(ion)
MTI	Moving Target Indicator(ion)

APPENDIX C (CONT'D)

LIST OF ASR-MTD ACRONYMS AND ABBREVIATIONS (CONTINUED)

P_D	Probability of Detection
P_{FA}	Probability of False Alarm
PE	Processing Element
PM	Processing Module
PMP	Parallel Microprogrammable Processor
PPI	Plan Position Indicator
PRF	Pulse Repetition Frequency
PRI	Pulse Repetition Interval
RAG	Range Azimuth Gain
ROM	Read Only Memory
R/T	Receiver/Transmitter
SCV	Sub-Clutter Visibility
SGP	Single Gate Processing
S_n	The n-th State
SRAP	Sensor Receiver and Processor
S/I	Saturation and Interference
S/N	Signal-to-Noise Ratio
STC	Sensitivity Time Control
STR	Target Report Strength
STU	System Timing Unit
T_0	Initial or Starting Time
TRACON	Terminal Radar Control
TTG	Test Target Generator
TTL	Transistor-to-Transistor Logic
USART	Universal Synchronous Asynchronous Receiver Transmitter
Wx	Weather
ZVF	Zero Velocity Filter