

**Project Report
ATC-256**

Beacon Radar and TCAS Reply Rates: Airborne Measurements in the 1090 MHz Band

**W. H. Harman
M. J. Brennan**

29 January 1997

Lincoln Laboratory
MASSACHUSETTS INSTITUTE OF TECHNOLOGY
LEXINGTON, MASSACHUSETTS

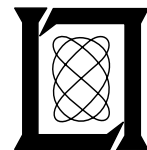

Prepared for the Federal Aviation Administration,
Washington, D.C. 20591

This document is available to the public through
the National Technical Information Service,
Springfield, VA 22161

This document is disseminated under the sponsorship of the Department of Transportation in the interest of information exchange. The United States Government assumes no liability for its contents or use thereof.

1. Report No. ATC-256		2. Government Accession No.		3. Recipient's Catalog No.	
4. Title and Subtitle Beacon Radar and TCAS Reply Rates: Airborne Measurements in the 1090 MHz Band				5. Report Date 29 January 1997	
				6. Performing Organization Code	
7. Author(s) William H. Harman, and Martin J. Brennan				8. Performing Organization Report No. ATC-256	
9. Performing Organization Name and Address MIT Lincoln Laboratory 244 Wood Street Lexington, MA 02173-9108				10. Work Unit No. (TRAIS)	
				11. Contract or Grant No. DTFA01-93-Z-02012	
12. Sponsoring Agency Name and Address Department of Transportation Federal Aviation Administration Systems Research and Development Service Washington, DC 20591				13. Type of Report and Period Covered ATC / January 1997	
				14. Sponsoring Agency Code	
15. Supplementary Notes This report is based on studies performed at Lincoln Laboratory, a center for research operated by Massachusetts Institute of Technology, under Air Force Contract F19628-95-C-0002.					
16. Abstract The Federal Aviation Administration (FAA) is in the process of developing Automatic Dependent Surveillance Broadcast (ADS-B) techniques. In one candidate system, GPS-Squitter, each aircraft periodically broadcasts messages, called "squitters," that report the aircraft's identification, position, and velocity. The position and velocity information may be obtained from the Global Positioning System (GPS). Reception of squitters can be used for several purposes, including surveillance of airborne aircraft by a ground station, surveillance of aircraft on the airport surface, and air-to-air surveillance. In developing the new system, it is necessary to know the rates of existing signal transmissions in the 1030 and 1090 MHz frequency bands, which are the beacon-radar and TCAS interrogation and reply channels. The GPS-Squitter would be transmitted in the 1090 MHz band, like a reply. A key issue is the possibility of interference to squitter reception from existing signals in the 1090 MHz band. To validate initial calculations, Lincoln Laboratory is making direct measurements of the rates of existing transmissions in both bands. This report describes the measurements in the 1090 MHz band. An instrumented aircraft was flown from Boston to New York and other locations while recording 1090 MHz receptions. The data has been processed to show the reception rates for Mode S replies and, separately, ATCRBS replies. The results have been plotted to show received rates vs. time and location. Results of this kind are given for Boston, New York, Philadelphia, Atlanta, Dallas, Lakeland FL, and the Los Angeles Basin. The results have also been used to support analyses of GPS-Squitter performance under current conditions and projected into the future.					
17. Key Words			18. Distribution Statement This document is available to the public through the National Technical Information Service, Springfield, VA 22161.		
19. Security Classif. (of this report) Unclassified		20. Security Classif. (of this page) Unclassified		21. No. of Pages 46	22. Price

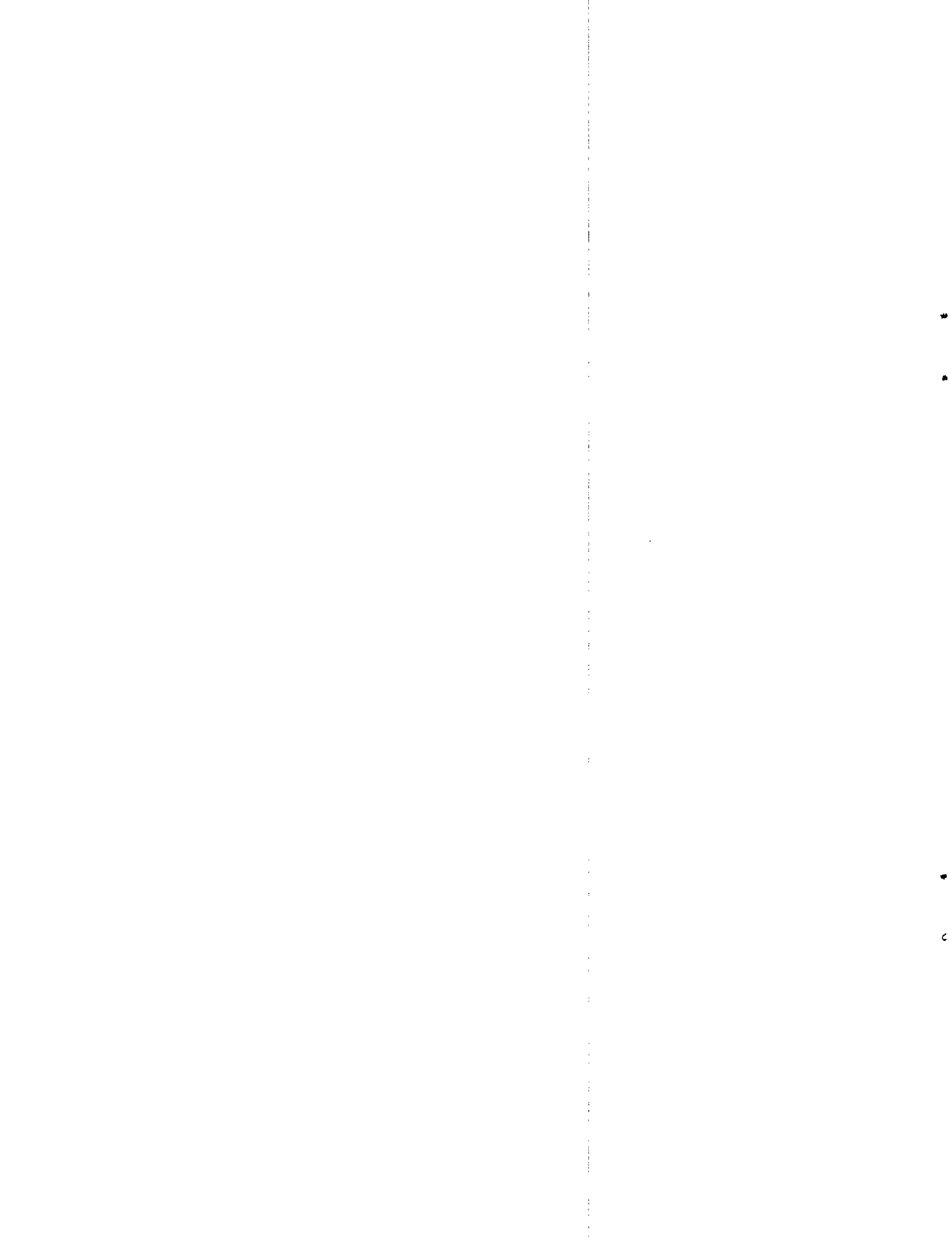
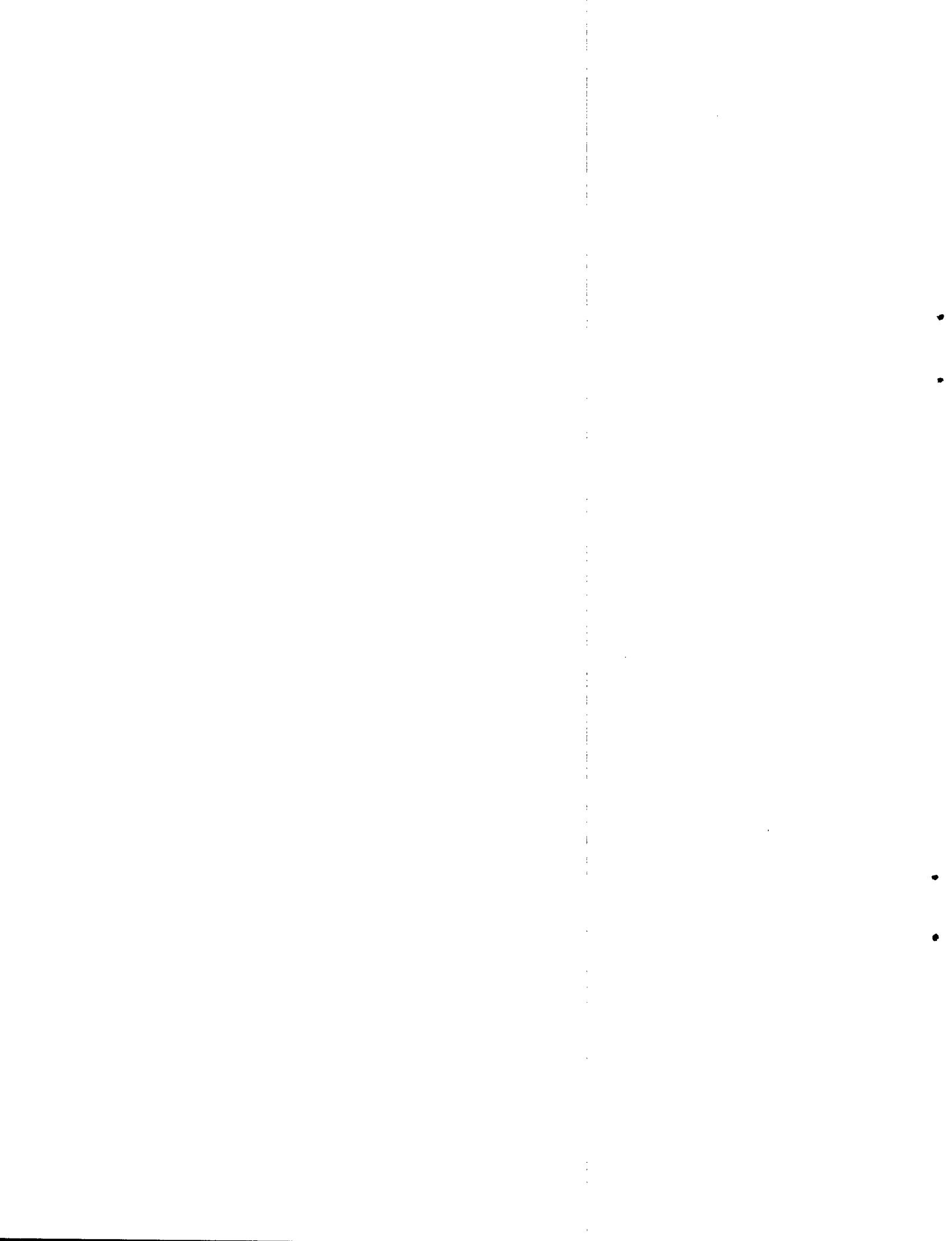

TABLE OF CONTENTS

List of Illustrations	v
1. INTRODUCTION	1
2. MEASUREMENT EQUIPMENT AND TECHNIQUES	3
3. AIRBORNE MEASUREMENTS: RESULTS AND DISCUSSION	9
3.1 New York and Philadelphia	9
3.2 Atlanta	14
3.3 Dallas	14
3.4 Los Angeles Basin	14
3.5 Boston	23
3.6 Lakeland	23
4. CONCLUSIONS	37
REFERENCES	39



LIST OF ILLUSTRATIONS

Figure No.		Page
1	The Airborne Measurement Facility.	4
2	Reply types.	5
3	Mode S and ATCRBS are compatible.	6
4	Flight path, New York and Philadelphia.	10
5	Measured reply rates, New York and Philadelphia.	11
6	Reply rate depends on receiver threshold.	13
7	Flight path, Atlanta.	16
8	Measured reply rates, Atlanta.	17
9	Flight path, Dallas.	18
10	Measured reply rates, Dallas.	19
11	Flight path, Los Angeles Basin.	20
12	Measured interrogation rates, LA Basin.	21
13	Measured reply rates, LA Basin.	22
14	Flight path, Bedford to Gardner.	24
15	Measured interrogation rates, Bedford to Gardner.	25
16	Flight path, Gardner to Bedford.	26
17	Measured reply rates, Gardner to Bedford.	27
18	Flight path, Lakeland, part A.	28
19	Measured interrogation rates, Lakeland, part A.	29
20	Flight path, Lakeland, part B.	30
21	Measured reply rates, Lakeland, part B.	31
22	Flight path, Lakeland, part C.	32
23	Measured interrogation rates, Lakeland, part C.	33
24	Flight path, Lakeland, part D.	34
25	Measured reply rates, Lakeland, part D.	35

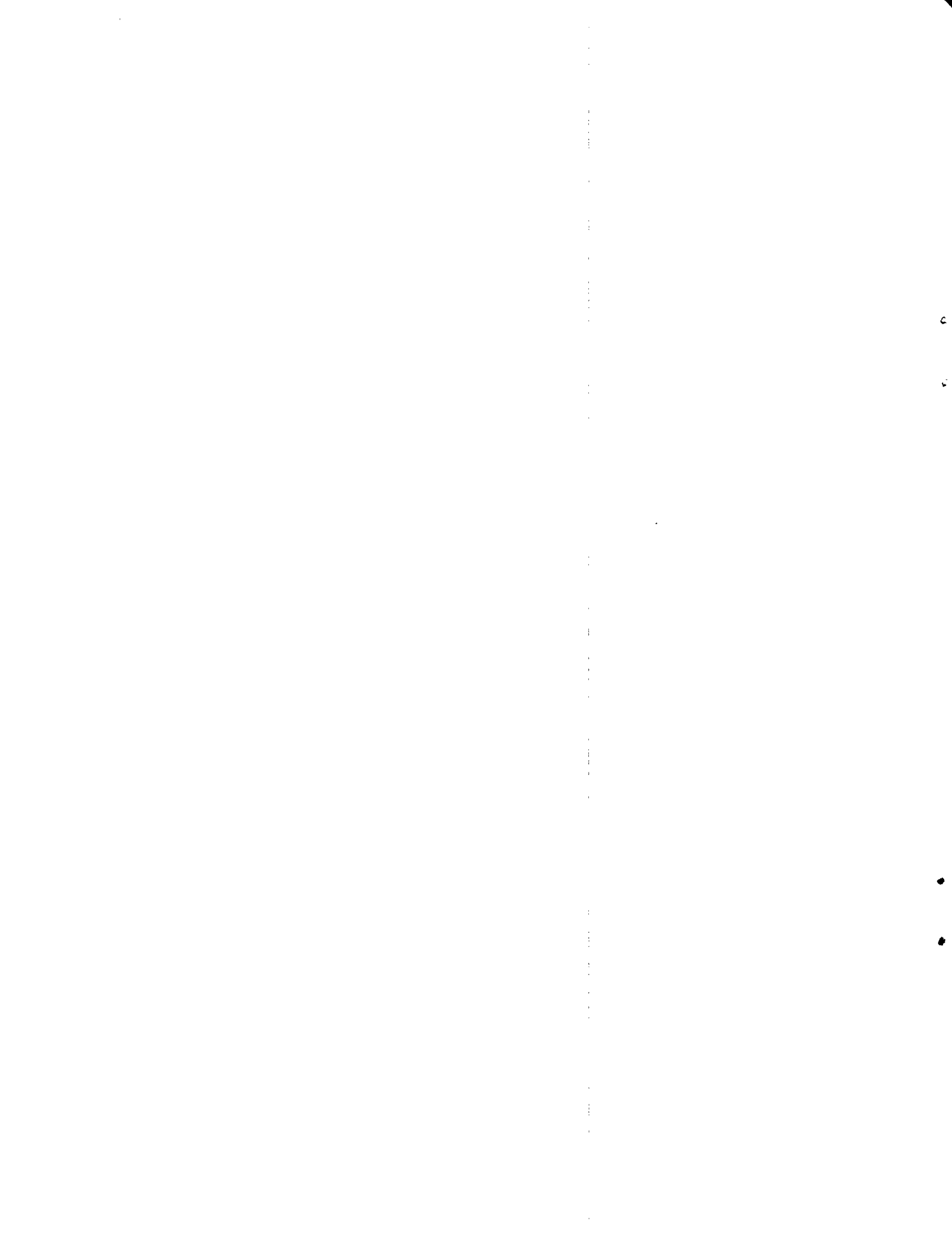

1. INTRODUCTION

The Federal Aviation Administration (FAA) is in the process of developing Automatic Dependent Surveillance Broadcast (ADS-B) techniques. In one candidate system, GPS-Squitter, each aircraft periodically broadcasts messages, called "squitters," that report the aircraft's identification, position, and velocity. The position and velocity information may be obtained from the Global Positioning System (GPS) or some other navigation device. Reception of squitters can be used for several purposes, including surveillance of airborne aircraft by a ground station, surveillance of aircraft on the airport surface, and air-to-air surveillance. Reference [1] provides a more detailed description of the GPS-Squitter concept.

In developing the new system, it is necessary to know the rates of existing signal transmissions in the 1030 and 1090 MHz frequency bands, which are the beacon-radar and TCAS interrogation and reply channels. The GPS-Squitter would be transmitted in the 1090 MHz band, like a reply. A key issue is the possibility of interference to squitter reception from existing signals in the 1090 MHz band. Reference [1] documents the initial calculations of the magnitude of these interference effects, and [2] provides more detailed calculations.

To validate these initial calculations, Lincoln Laboratory has made direct measurements of the rates of existing transmissions in both bands. These signals consist mainly of interrogations in the 1030 MHz band and replies in the 1090 MHz band. This report focuses on airborne measurements that have been made at 1090 MHz. A companion report [3] documents measurements at 1030 MHz. Reference [4] documents earlier airborne measurements, made in 1978, in the 1090 MHz band, that can be compared with the results given herein.

An instrumented aircraft was flown from Boston to New York and other locations while recording 1090 MHz receptions. The data has been processed to show the reception rates for Mode S replies and, separately, ATRBS replies. The results have been plotted to show received rates vs. time and location. Results of this kind are given for Boston, New York, Philadelphia, Atlanta, Dallas, Lakeland FL, and the Los Angeles Basin. The results have also been used to support analyses of GPS-Squitter performance under current conditions and projected into the future.

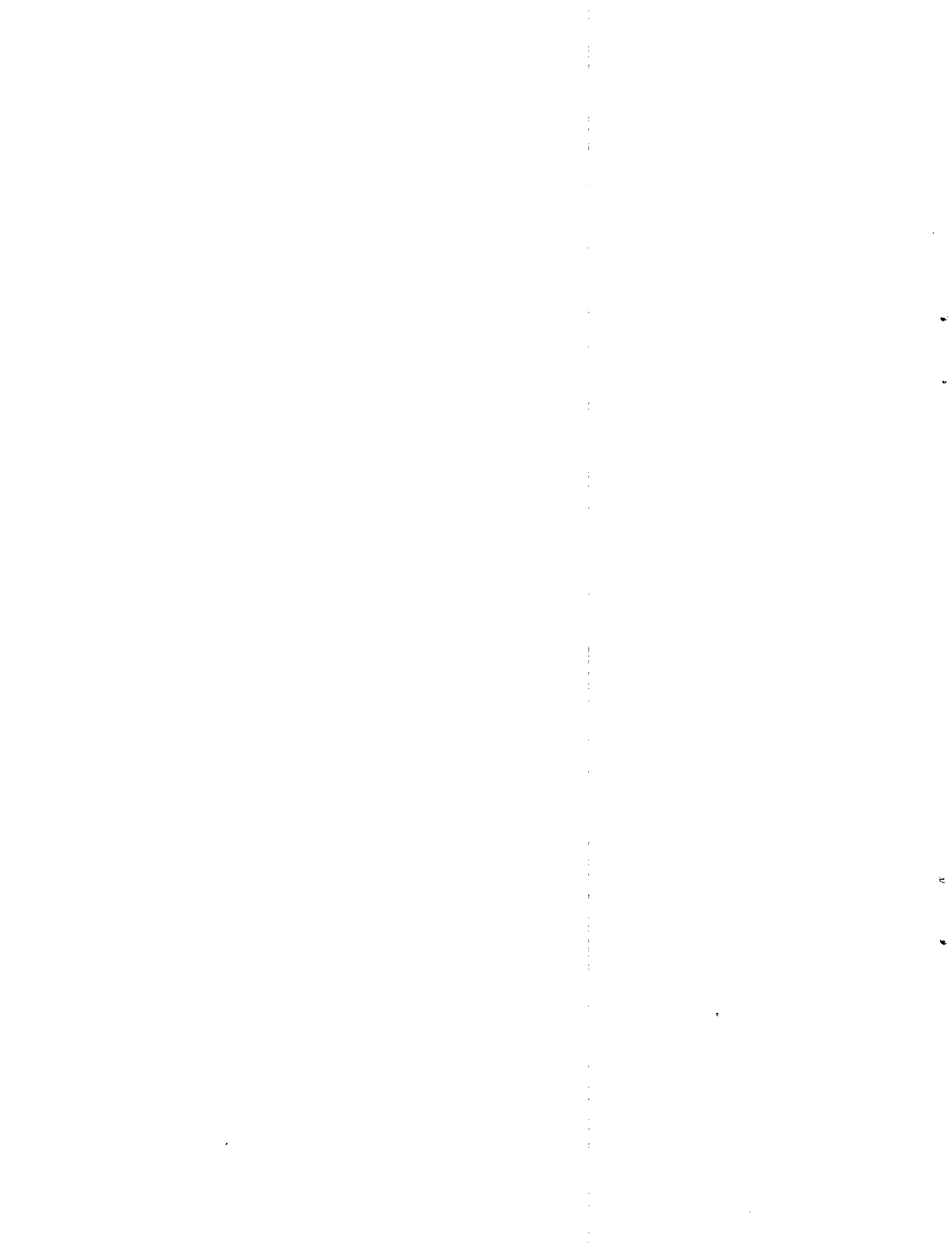

2. MEASUREMENT EQUIPMENT AND TECHNIQUES

During the Mode S development program, MIT Lincoln Laboratory designed and built an "Airborne Measurement Facility" (AMF) for measuring beacon radar signals in the 1030 and 1090 MHz bands. When used at 1090 MHz in the normal mode, the AMF digitizes each received pulse and records it on tape as one pulse word, containing the received power level, the pulse width, and the time of reception. The recorded data is subsequently played back and analyzed to recognize pulse combinations that constitute replies, which are then counted to determine reply rates.

The configuration of the equipment is illustrated in Figure 1. The functions of the AMF are documented in more detail in [5]. The data recording subsystem of the AMF was upgraded in 1993, as documented in [6].

During playback, the data analysis software distinguishes two reply types: Mode S and ATCRBS, illustrated in Figure 2. The Mode S reply begins with a 4-pulse preamble whose function is to identify this type of reply and synchronize the receiver for reading the data block. The data block consists of 56 bits (a "short reply") or 112 bits (a "long reply"). Pulse position modulation is used in the data block, with 1 bit transmitted in each μs . Within each 1 μs period, a pulse is transmitted in either the first half or in the second half. If the pulse is in the first half, the bit is a 1; otherwise it is a 0.

The other reply type, called ATCRBS (Air Traffic Control Radar Beacon System) includes Modes A and C and the military Modes 1 and 2, which have the same reply format. Each ATCRBS reply consists of a sequence of pulses of width 0.45 μs . The reply includes two framing pulses spaced 20.3 μs . Between these are 13 pulse positions in which a pulse may be present or absent. Normally the central pulse position, called the "X pulse", is absent, and the remaining 12 pulse positions are used to convey 12 bits of information. In Mode A, the information is the beacon code of the aircraft. In Mode C, the information is the altitude.

Mode S replies are transmitted by Mode S transponders in response to interrogations from Mode S ground stations and TCAS*. ATCRBS replies are transmitted by ATCRBS transponders in response to interrogations from ATCRBS ground stations and TCAS. The term ATCRBS is used here to mean a transponder or a ground station not capable of Mode S signaling. Mode S and ATCRBS are compatible, having interoperability conditions that are summarized in Figure 3.

* The Traffic Alert and Collision Avoidance System (TCAS) is airborne equipment that uses air-to-air signaling for collision avoidance.

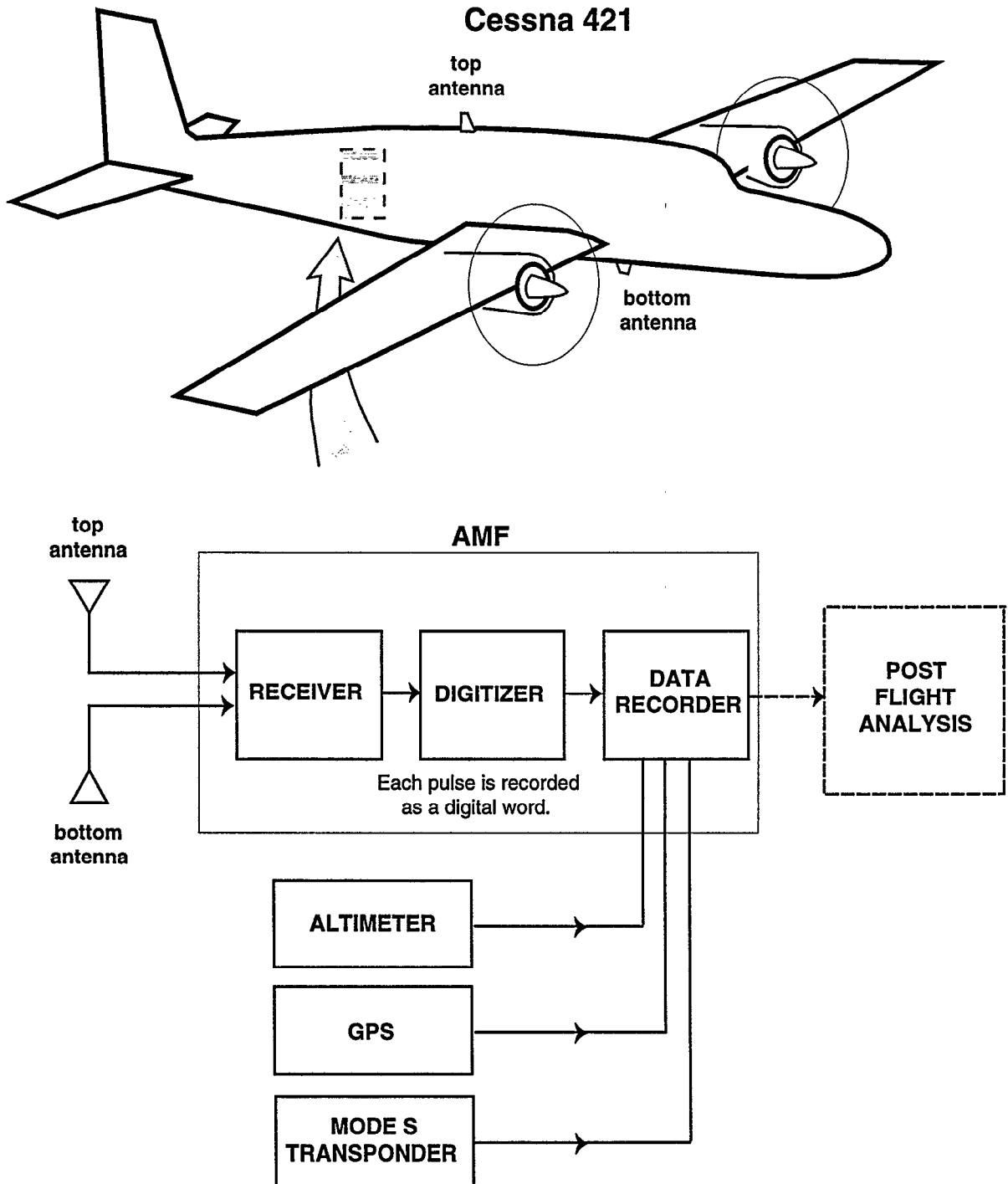
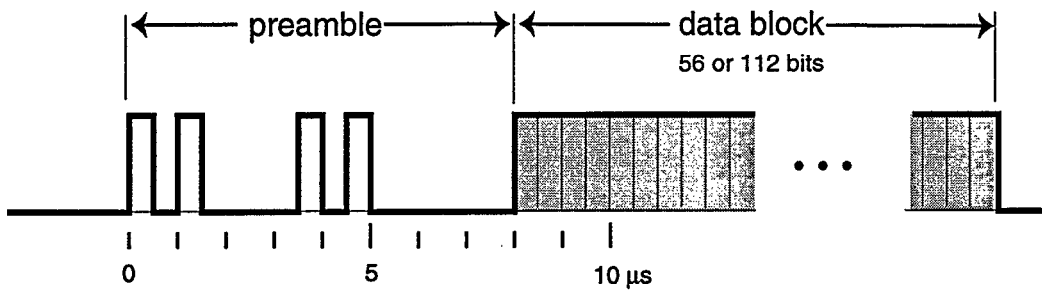

Figure 1. The Airborne Measurement Facility. This equipment is used for measuring receptions at 1030 MHz or 1090 MHz. The recorded data are in a detailed form, one word for each received pulse. Subsequent data analysis is used to identify interrogations (1030 MHz) and replies (1090 MHz).

Mode S Reply



ATCRBS Reply (Modes 1, 2, A, or C)

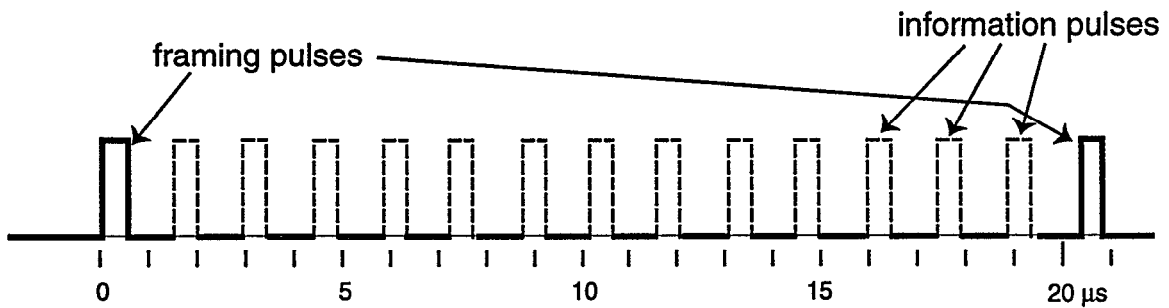

Figure 2. Reply formats. Both Mode S and ATCRBS replies are used in the 1090 MHz band. A Mode S reply contains 56 or 112 bits (a "short reply" or a "long reply", respectively). An ATCRBS reply contains as many as 13 bits. In Mode C, the ATCRBS reply reports aircraft altitude in a code of 11 bits.

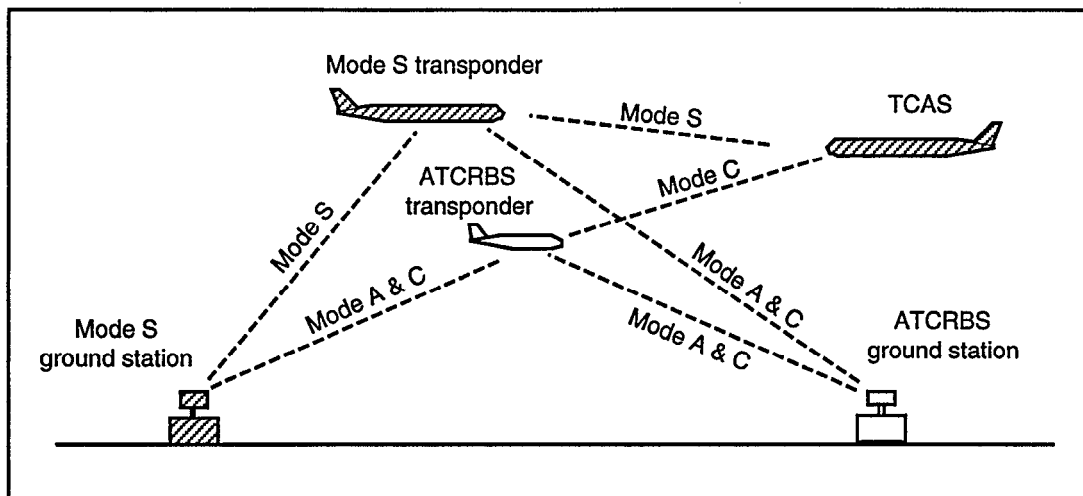

Figure 3. Mode S and ATCRBS are compatible. Both Mode S aircraft and ATCRBS aircraft are seen by both types of ground stations and by TCAS.

In addition, a Mode S transponder transmits unsolicited replies called squitters at a rate of 1/sec. A Mode S squitter has the same format as a Mode S reply. For this reason, squitters are counted along with Mode S replies, and are included in the rates presented below.

The AMF is capable of receiving at either 1030 MHz or 1090 MHz, but not both at one time. In many of the measurement flights, we switched the receiving frequency from one band to the other in order to obtain both types of data.

When flying in a high density area, the reception rate of pulses in the 1090 MHz band can be so high that it would exceed the recording capacity of the AMF unless special steps were taken. For example, the reply rate could be 10,000 replies per sec., which corresponds to about 80,000 pulses per second, whereas the capacity of the AMF is 30,000 pulses per second. To keep within the AMF capacity, we have added a time gating function that reduces reception rate by a factor of 100. This is a periodic gate that blocks receptions for 99 ms and passes receptions for 1 ms, repeating this pattern each 100 ms. Although only 1 percent of all receptions are recorded, this sampling technique is considered to be satisfactory for measuring reply rates.

Alternatively, it would have been possible to reduce the receiver sensitivity to a point where the reception rate is within the capacity of the AMF, but this is considered less attractive because of the loss of low-power receptions. In the above example, a reception rate of 80,000 pulses per second would apply at a nominal receiver sensitivity of -74 dBm referred to the antenna*. To reduce this to 30,000 pulses per second would require a desensitization of the receiver by about 10 dB. From such limited data, the full reception rate could conceivably be estimated, but that estimate would be much less accurate than results obtained using the sampling technique.

* The nominal value of receiver sensitivity for TCAS is -74 dBm referred to the antenna.

In fact, to provide more flexibility, the airborne measurements were carried out with a receiver set to a level somewhat more sensitive than the nominal value. Then filtering by power was used during data analysis to obtain results for the nominal threshold value, -74 dBm referred to the antenna. The actual receiver threshold was set to a level several dB more sensitive than the nominal value. The extended sensitivity was used in order to provide flexibility in processing the data, and accordingly some of the results are presented as a function of receiver threshold, extending below the normal threshold value.

The AMF also records data from several peripheral units as illustrated in Figure 1. These include an altimeter, a GPS receiver (to record the position of the aircraft as a function of time), and a Mode S transponder (to provide a count of the TCAS aircraft in the vicinity). The AMF and this peripheral equipment have been installed in a Cessna 421 twin engine aircraft. The aircraft is equipped with both a top antenna and a bottom antenna. They are both short monopoles, typical of the antennas used for aircraft transponders.

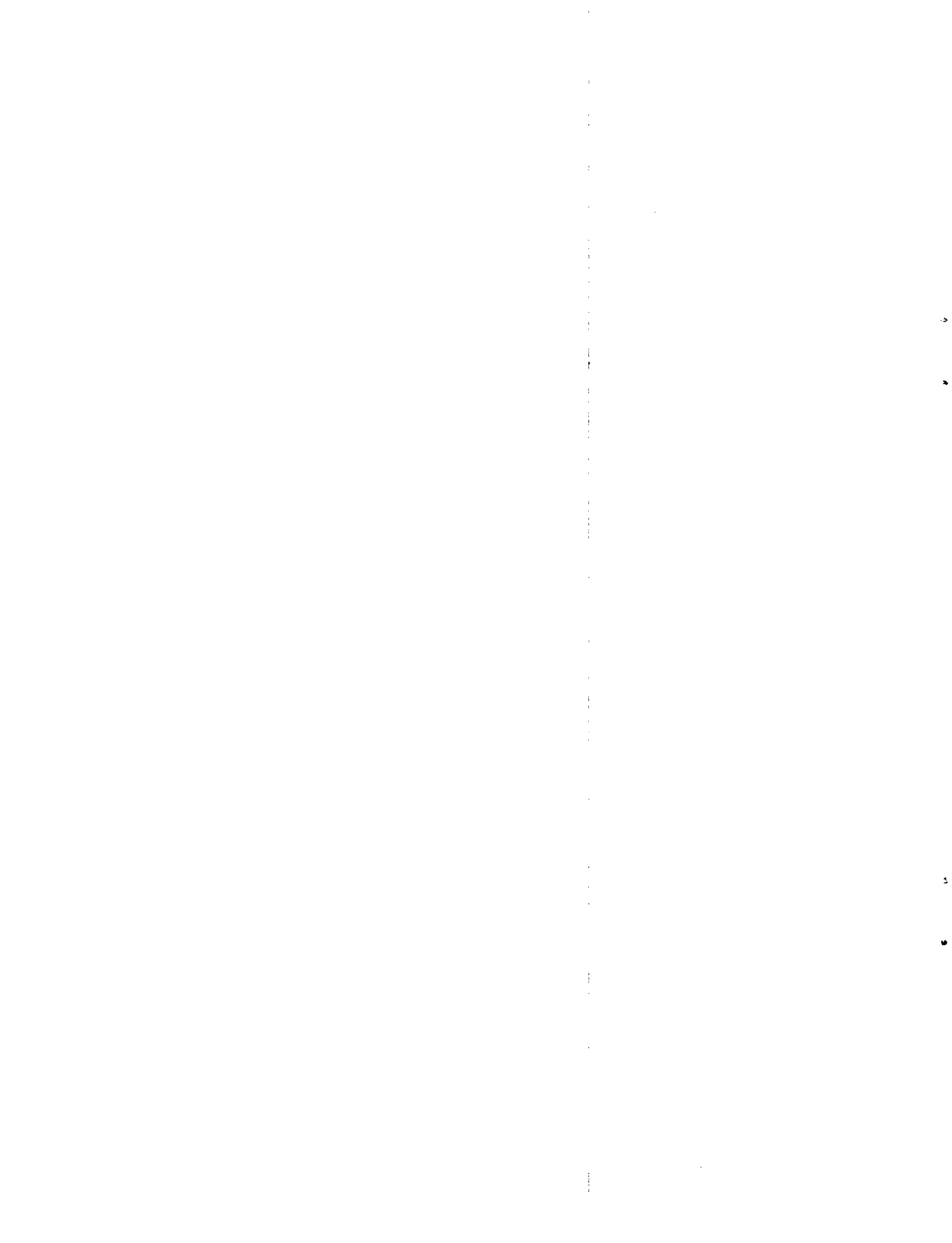

3. AIRBORNE MEASUREMENTS: RESULTS AND DISCUSSION

Airborne measurements of the reply rate at 1090 MHz have been made in Boston, New York, Philadelphia, Atlanta, Dallas, Lakeland FL, and the Los Angeles Basin. This section presents the flight paths and the measured rates together with a discussion of the results.

The points of discussion mainly concern the validity of the measured values. Some simple calculations are presented for comparison with the measurements. These calculations were not predictions made before the measurement, but are intended as reasonableness comparisons. Accurate predictions would require a knowledge of the number of aircraft and their locations at the time of the measurements, which was beyond the scope of this effort.

The results are presented first for a flight over New York and Philadelphia, followed by a discussion of these results. Most of the qualitative results and conclusions become evident from this first data set. Subsequently, the data from the other locations are presented with discussion of any differences.

3.1 NEW YORK AND PHILADELPHIA

3.1.1 Flight Path and Measured Reply Rate

On 1 August 1994, the Cessna 421 aircraft equipped with the AMF flew along the East Coast, beginning in Bedford, Massachusetts, and passing over New York and Philadelphia. The flight path is shown in Figure 4. Altitude was nearly constant at 6000 ft. as plotted in the figure. The received reply rates measured during the flight are plotted in Figure 5. Each point plotted is the average rate of replies received during a 1-minute period of time.

Measurements were made both at 1030 MHz and 1090 MHz, which required the AMF to be switched between the two frequency bands. This is the reason the results in Figure 5 are shown for two separate time periods; 1030 MHz measurements (documented in [3]) were being made the rest of the time.

The results in Figure 5 are given separately for top-antenna receptions and bottom-antenna receptions. In both cases, the receiver threshold is -74 dBm referred to the antenna. The plotted results show both ATCRBS replies and Mode S replies. ATCRBS replies include Modes 1, 2, A, and C. Mode S replies include both long and short replies and squitters.

It is to be expected that raising the receiver threshold will reduce the rate of replies received, and vice versa. Figure 6 shows how the measured reply rates changed as a function of receiver threshold. Each point plotted is the average received reply rate over a 3-minute period, taken from the beginnings of the two recording periods plotted in Figure 5.

3.1.2 Discussion of Results

The results in Figure 4 indicate that the Mode S reply rate is much lower than the ATCRBS reply rate—lower by a factor of about 10 to 40. This difference is to be expected because Mode S ground stations were not operational at the time of these measurements, and also because most ATCRBS ground stations elicit a large number of replies from a single aircraft in making one azimuth measurement. Because Mode S ground stations were not yet operational, it can be assumed that all of the Mode S replies were replies to TCAS interrogations. The vast majority of the received Mode S replies were in the short format (56 bits).

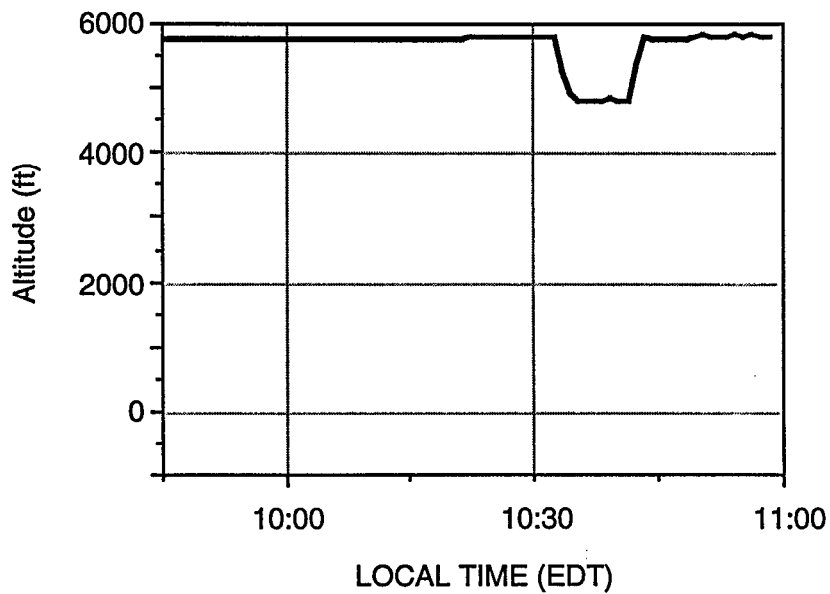
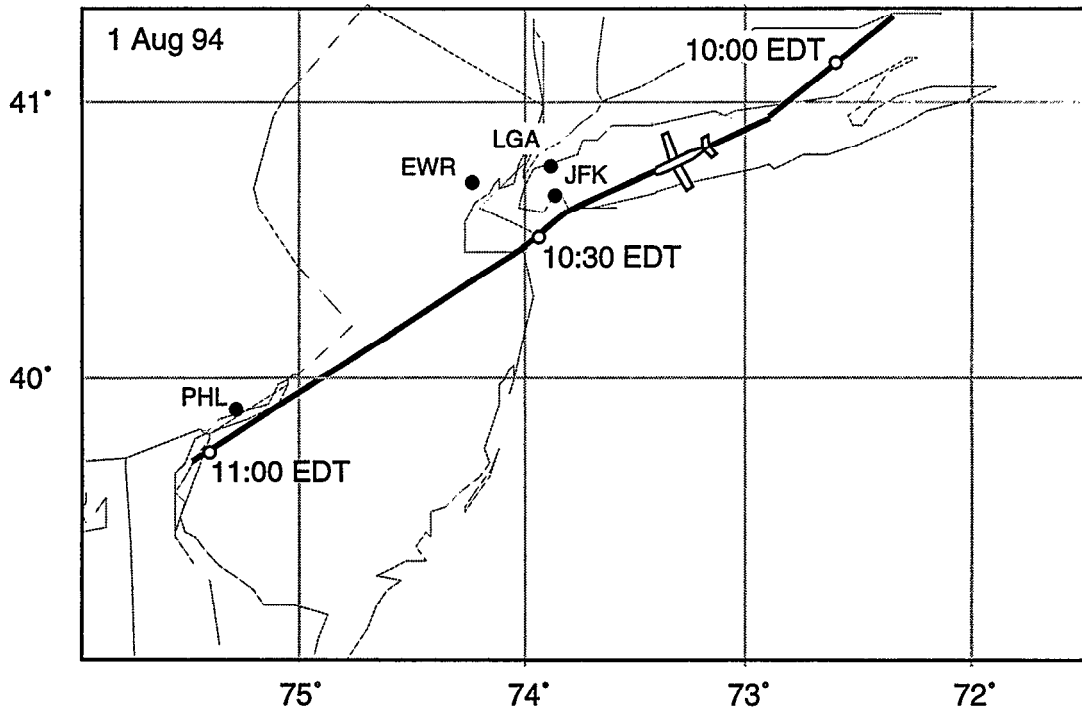
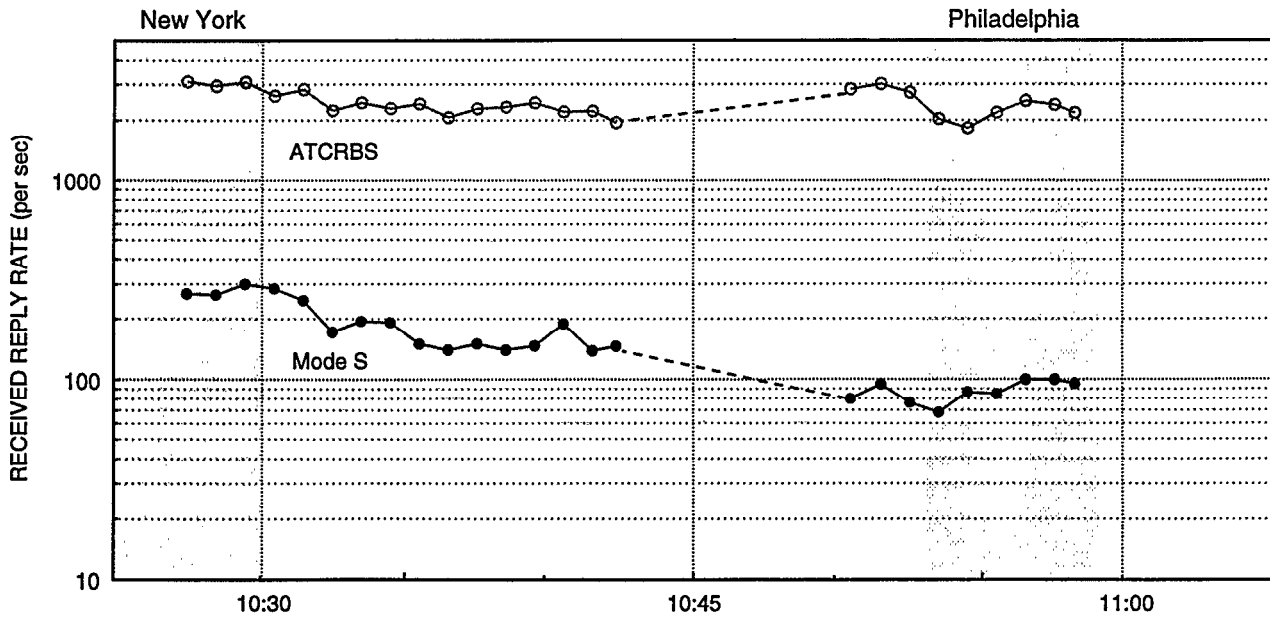

Figure 4. Flight path, New York and Philadelphia. The results plotted in Figure 5 were obtained while flying on this path. The receiver was switched between 1030 MHz reception and 1090 MHz reception, giving rise to the grouping of points in Figure 5.

TOP ANTENNA



BOTTOM ANTENNA

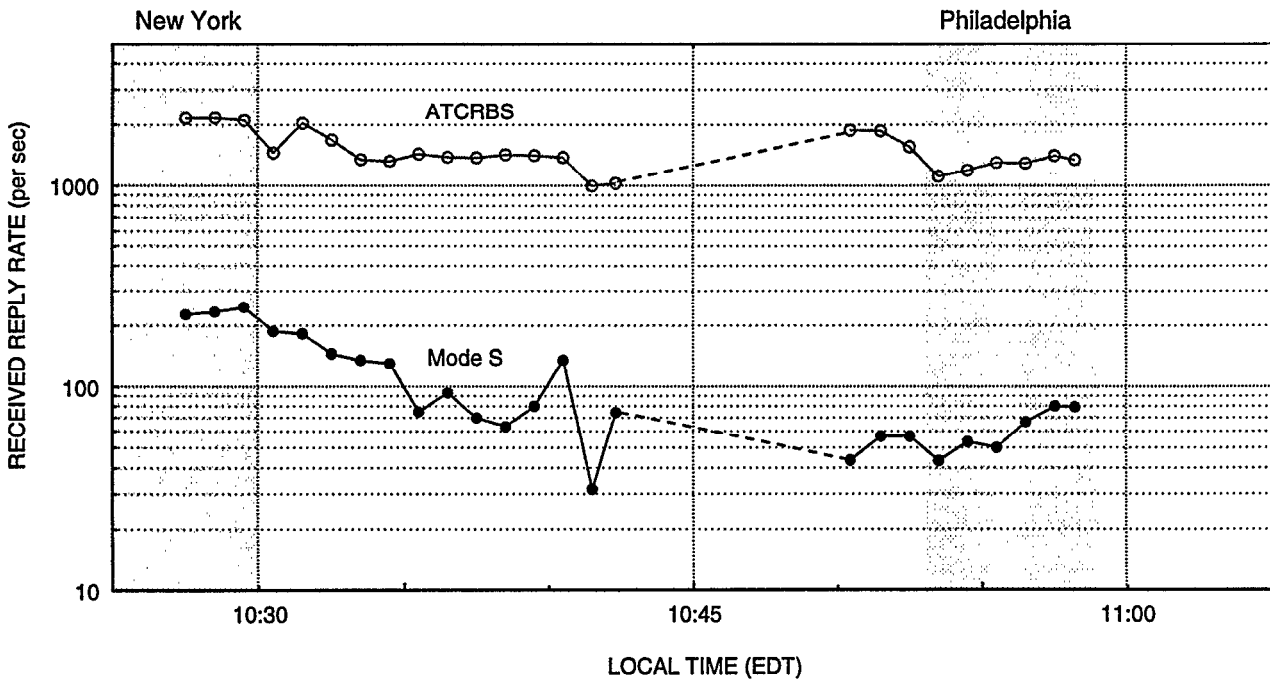

Figure 5. Measured reply rates, New York and Philadelphia. This is the main type of result obtained by airborne AMF recording followed by analysis of the recorded data. Mode S reply rates are lower than ATCRBS reply rates by a large factor. The maximum rates were observed in the New York area.

For comparison with the observed ATCRBS reply rate, a rough estimate of the rate that would be expected can be made as follows. For the nominal receiver sensitivity, -74 dBm referred to the antenna, the nominal air-to-air range is about 30 nmi [7]. Therefore, the reply receptions originate primarily from the aircraft within 30 nmi of the receiving aircraft. The number of aircraft within 30 nmi of Philadelphia is about 50 [8]. Based on the interrogation rate measurements given in Reference 3, we may estimate the average ATCRBS reply rate over a region of 30 nmi radius as 60 replies per second. Multiplying the number of aircraft by the average reply rate yields a total received reply rate:

$$(50 \text{ aircraft}) \times (60 \text{ replies/sec}) = 3000 \text{ received replies/sec}$$

By comparison, the measured values (Figure 5) reach a maximum of about 3000/sec. on the top antenna and 2000/sec. on the bottom antenna.

The agreement between the above calculation and the measurements is good, but it should be kept in mind that variations on the order of 2:1 and larger are to be expected because of variations in the number of aircraft and the interrogation environment. The conclusion from this comparison is simply that the measured results appear to be valid, and the understandings of the mechanisms that govern the environment of reply receptions are consistent with the observations.

Top-antenna receptions and bottom-antenna receptions in Figure 5 follow the same trend, with the top receptions consistently greater in number. This behavior is consistent with earlier measurements [Reference 4]. The difference is thought to result from the fact that most replies are transmitted from a bottom antenna.

The rate-vs-threshold results in Figure 6 show an expected decrease of the reception rate when threshold is raised. Following are two simple models that can be used for comparison with the observed rate of change.

Suppose receiver threshold were reduced by 6 dB. This would increase the reception range by a factor of 2, which would increase the reception area by a factor of 4. If the aircraft transmitting replies were uniformly distributed in area, then the total number of contributing aircraft would be increased by a factor of 4. The total reception rate would also increase by that factor, assuming the average reply rate per aircraft was constant. An alternative model that is more appropriate for locations like New York and Philadelphia is that the aircraft are concentrated near the center, having a uniform-in-range distribution. For this model, the reduced threshold would increase the number of aircraft received by a factor of 2. Generalizing this behavior for any amount of change in receiver threshold, the two models can be summarized as follows.

Uniform-in-area distribution: Rate changes by 4:1 for each 6 dB change.

Uniform-in-range distribution: Rate changes by 2:1 for each 6 dB change.

Both models would appear as straight lines in Figure 6, which is a log-log plot. Examples of these straight lines are marked in Figure 6.

Comparing the measurements with these models, we note that the measured trends are between these two models and in most cases close to the uniform-in-range model. That is, the measured rates vary approximately linearly with threshold (in the log-log plot) and with a slope that is approximately 2:1 per 6 dB. This seems reasonable in view of the fact that the data in this figure apply to the high-density areas of New York and Philadelphia.

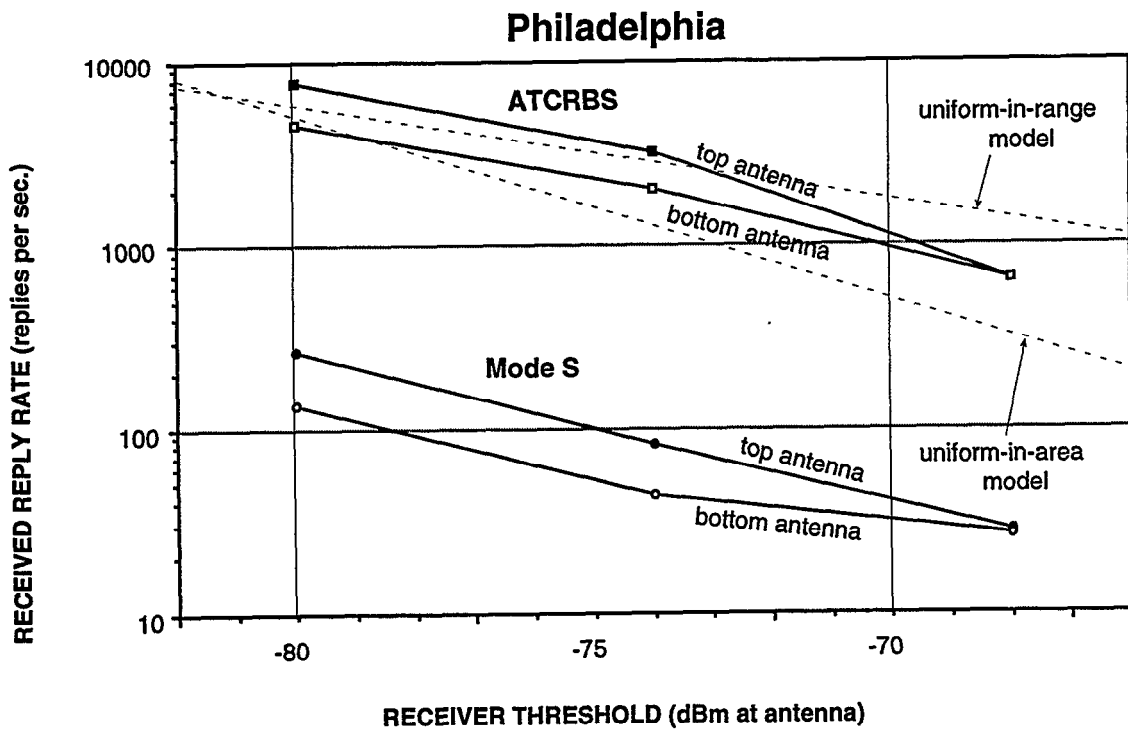
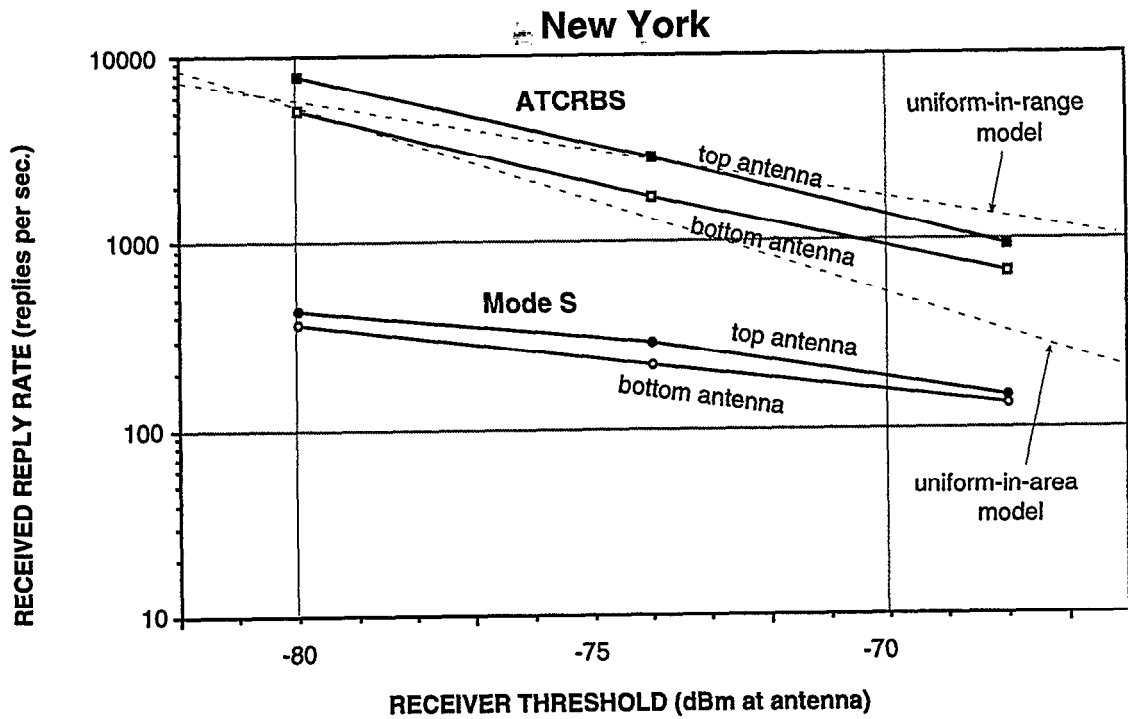

Figure 6. Reply rate depends upon receiver threshold. As expected, an increase in receiver threshold causes a decrease in received reply rate. These results are seen to be approximately consistent with a simple uniform-in-range model describing the distribution of aircraft transmitting replies.

Previous airborne measurements of 1090 MHz receptions were made in 1978 [4]. Comparing these with the current measurements provides an opportunity to determine if these rates have increased over the intervening 16 years. Specifically:

	<u>1978</u>	<u>1994</u>
New York	2800, 3500/sec.	2000/sec.
Philadelphia	4000/sec.	2000/sec.

All of these values refer to ATCRBS replies received on the bottom antenna, with the standard value of receiver threshold (-74 dBm at antenna), and are average rates over 4 minutes. In the case of New York, measurements were made on two different days, so both values are given here.

In understanding why the received reply rate would change over time, we need to consider the two basic factors, interrogation rate and density of aircraft. It is known that the interrogation environment has decreased significantly over several decades, presumably as a result of FAA efforts to improve the efficiency of operations in this band [3]. On the other hand, the density of aircraft would be expected to have increased somewhat over this period of several decades. Given the two opposite trends, it may not be immediately clear whether one effect dominates over the other. Consequently it is useful to make direct 1090 MHz measurements such as these, to determine the nature of the changes, if any.

The results in this table indicate that there have not been large changes over this time period. Bearing in mind the variability of such measurements, which would make it impossible to see small changes, the comparison suggests that relatively minor decreases have likely occurred in both New York and Philadelphia.

3.2 ATLANTA

The August 1994 flight of the AMF continued on to Atlanta and then Dallas. The flight path for 1090 MHz measurements in Atlanta is plotted in Figure 7. Measured reply rates are plotted in Figure 8. The received rates are similar in character to the results from New York and Philadelphia, except somewhat lower.

3.3 DALLAS

In Dallas, the AMF aircraft was flown at a constant altitude of 11000 ft. nearly directly over the Dallas-Fort Worth airport as shown in Figure 9. The measured reply rates are plotted in Figure 10. During this time, the AMF was switched alternately between 1030 MHz and 1090 MHz, which is the reason that the data points in Figure 10 appear in bunches. The received rates are similar in character to the results given above, except that the Mode S reply rate is somewhat higher. A peaking of receptions is seen to occur near the airport.

3.4 LOS ANGELES BASIN

Airborne AMF measurements were made in the Los Angeles Basin on 15 February 1995. The flight path, shown in Figure 11, was chosen to include the busiest areas, passing directly over

LAX airport and also passing through Long Beach. Long Beach has been previously determined to have the maximum density of aircraft [8]. Measurements were alternated between 1030 MHz and 1090 MHz, yielding the results given in Figures 12 and 13. Interrogation rates are included here as well as reply rates because these have not been reported elsewhere.

The rates of both interrogations and replies are seen to be significantly higher than the results up to this point. ATCRBS interrogation rates from ground based radars exceeded 100 per second often, especially via the bottom antenna. A pronounced peak in interrogation rate occurred in the vicinity of Garden Grove, with the bottom receptions much higher than the top receptions. This pattern suggests that a single radar contributed most of these interrogations, perhaps because sidelobe suppression was ineffective or absent.

Reply rates are also significantly higher, exceeding 10,000 ATCRBS replies per second in the Long Beach area. Given the high observed interrogation rate (over a small region) and the expectation of high aircraft density around Long Beach, a fruit rate calculation for comparison with the measured values is as follows.

$$(90 \text{ aircraft}) \times (100 \text{ replies/sec}) = 9000 \text{ received replies/sec}$$

As discussed above, these are rough estimates which should not be expected to predict results accurately. We conclude simply that the degree of consistency between the calculation and the measurements is reassuring in that it supports the validity of the measurements and also supports our understanding of the underlying mechanisms.

Los Angeles is another case in which a comparison can be made with previous measurements [4]. Following is a summary of comparable values.

	<u>1978</u>	<u>1994</u>
New York	2800, 3500/sec.	2000/sec.
Philadelphia	4000/sec.	2000/sec.
LAX	6000, 3000, 6000, 4000/sec.	7000/sec., 6000/sec.
Long Beach	7000, 5500, 5000, 6500, 3000/sec.	12000/sec., 6500/sec.

As before, all of these values refer to ATCRBS replies received on the bottom antenna, with the standard value of receiver threshold (-74 dBm at antenna), and are average rates over 4 minutes. In some cases, repeated measurements were available from different passes or different days. The New York and Philadelphia values from above are repeated here for ease of comparison.

Whereas the East Coast data suggests a small decrease in the reply environment, the Los Angeles data seems to suggest a small increase. Keeping in mind the variability of such measurements, our principal conclusion from these results is simply that the 1090 MHz reply-rate environment has not undergone large changes over this time period.

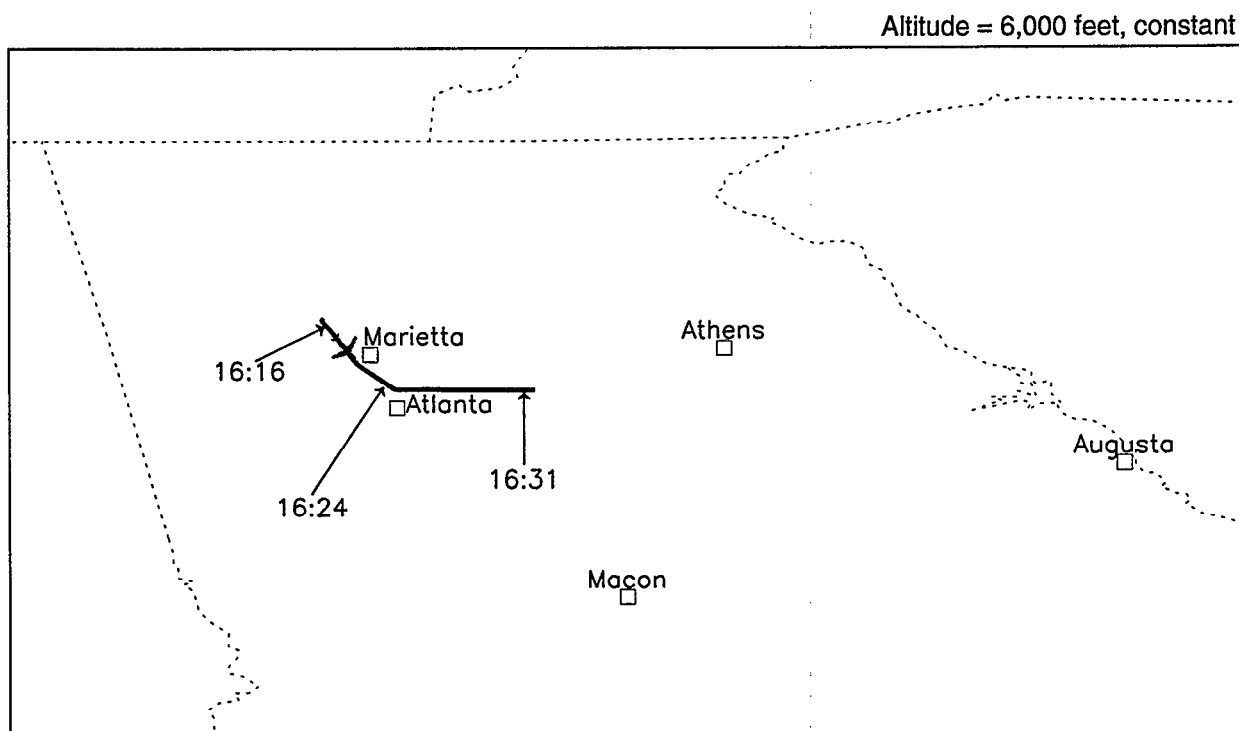
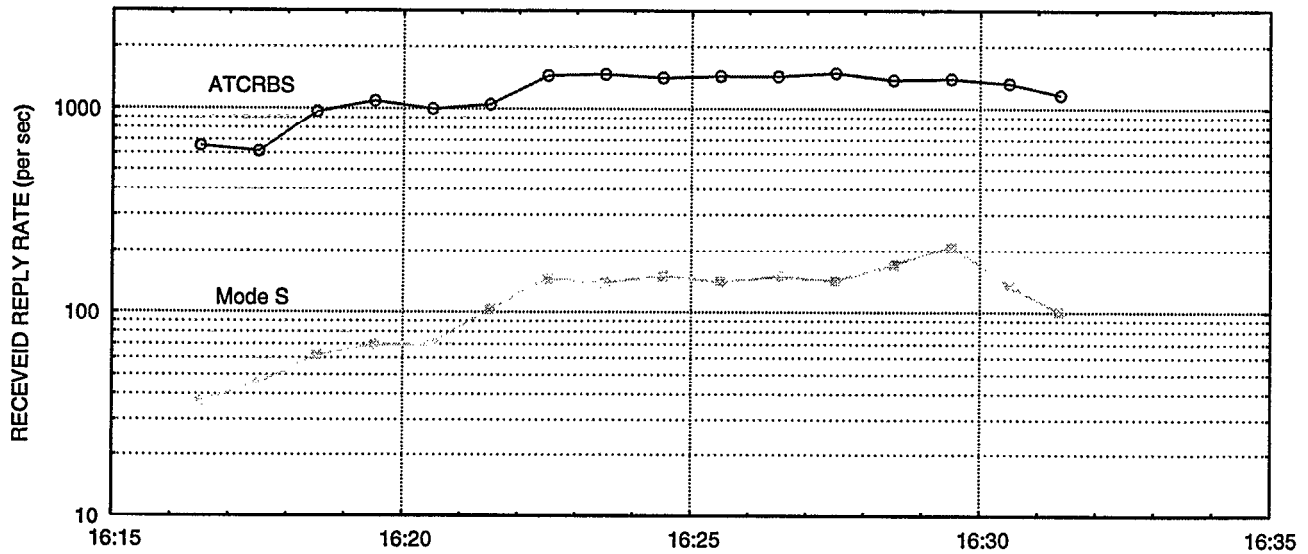

Figure 7. Flight path, Atlanta. Measurements were made at 1090 MHz while flying toward the Atlanta International airport from the northwest and then continuing toward the east. The altitude was constant at 6000 ft during this pass.

TOP ANTENNA



BOTTOM ANTENNA

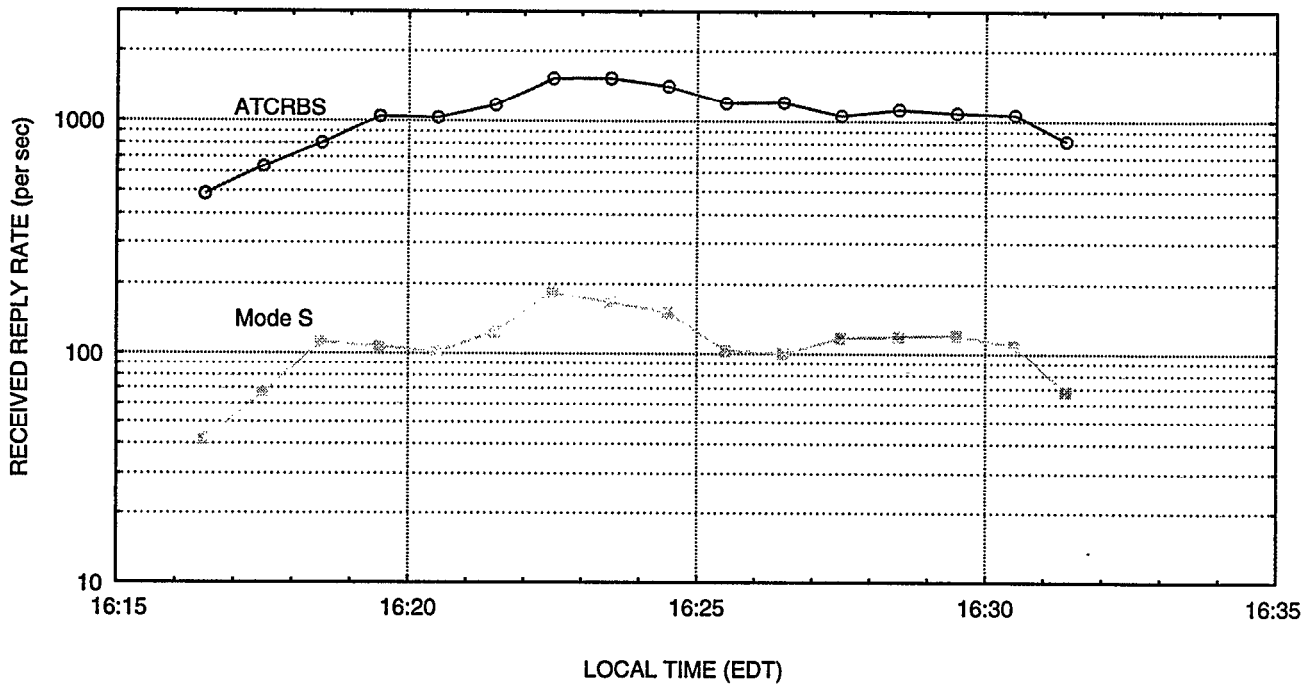

Figure 8. Measured reply rates, Atlanta. The results are similar to the behavior seen at New York and Philadelphia, Mode S rates substantially lower than ATCRBS rates, and rising to a maximum around the city of Atlanta.

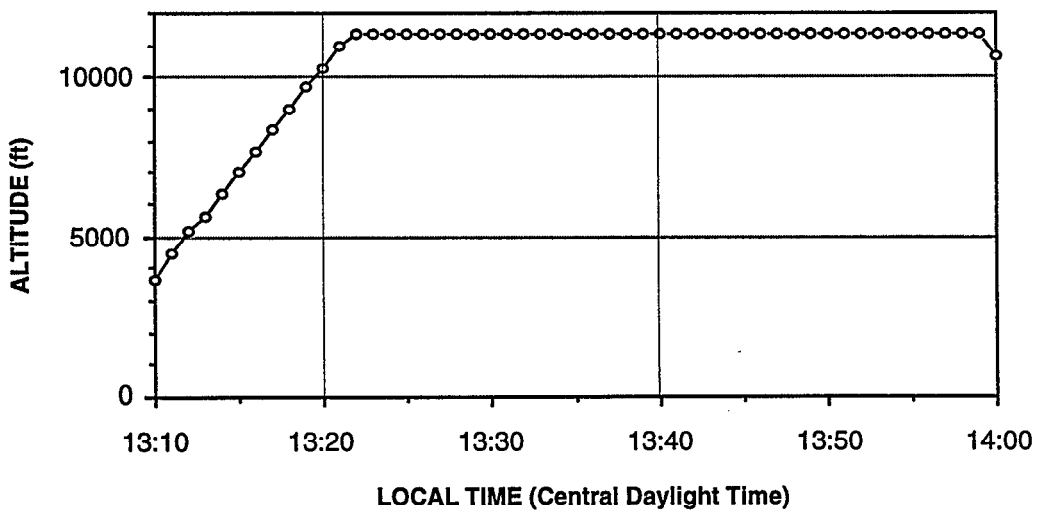
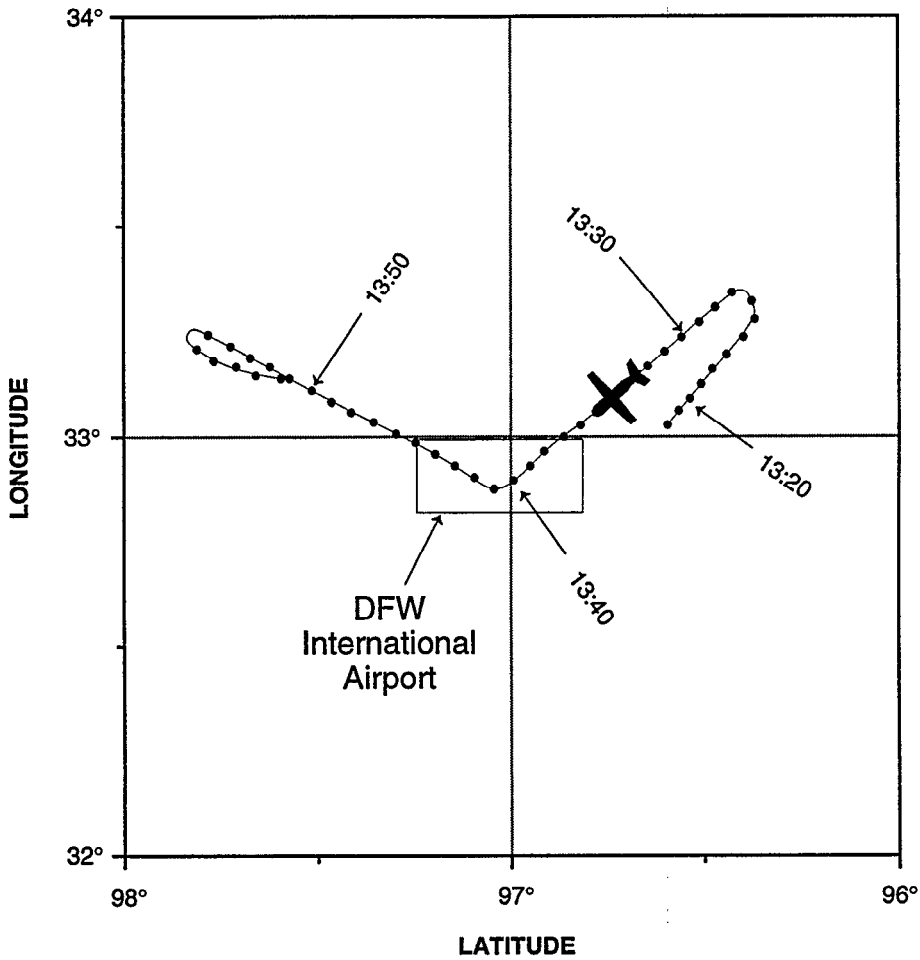
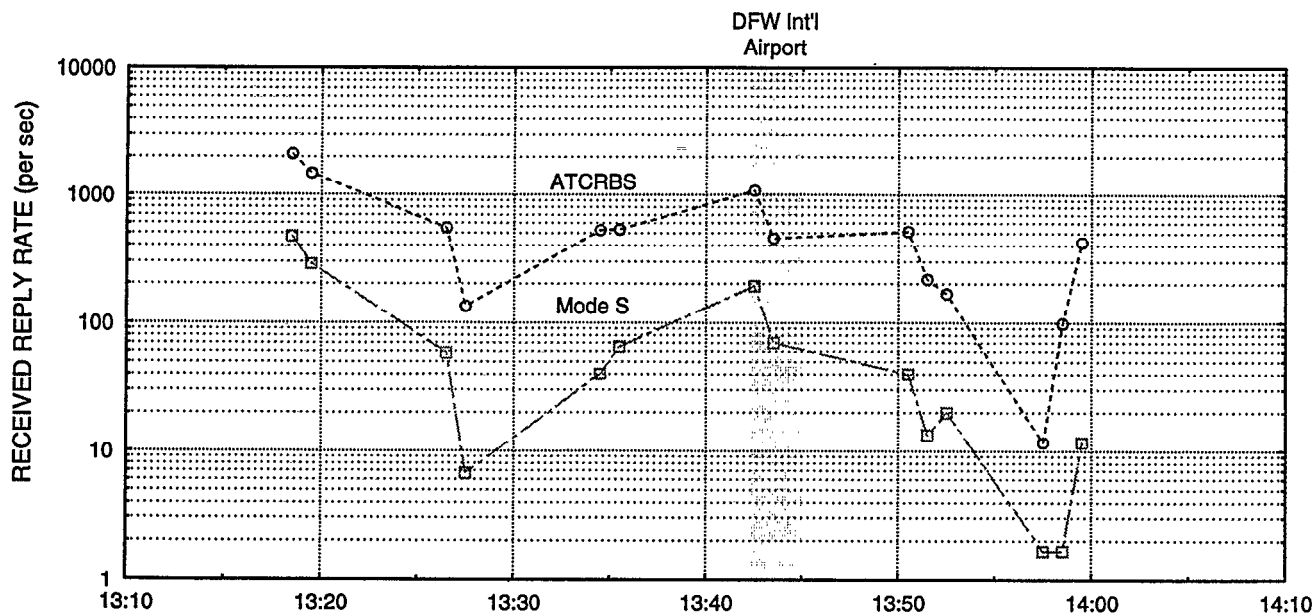

Figure 9. Flight path, Dallas. This shows the path of the AMF aircraft when the rates in Figure 10 were recorded. During this flight, the AMF was switched between 1030 and 1090 MHz, which is the reason for the grouping of points in Figure 10.

TOP ANTENNA



BOTTOM ANTENNA

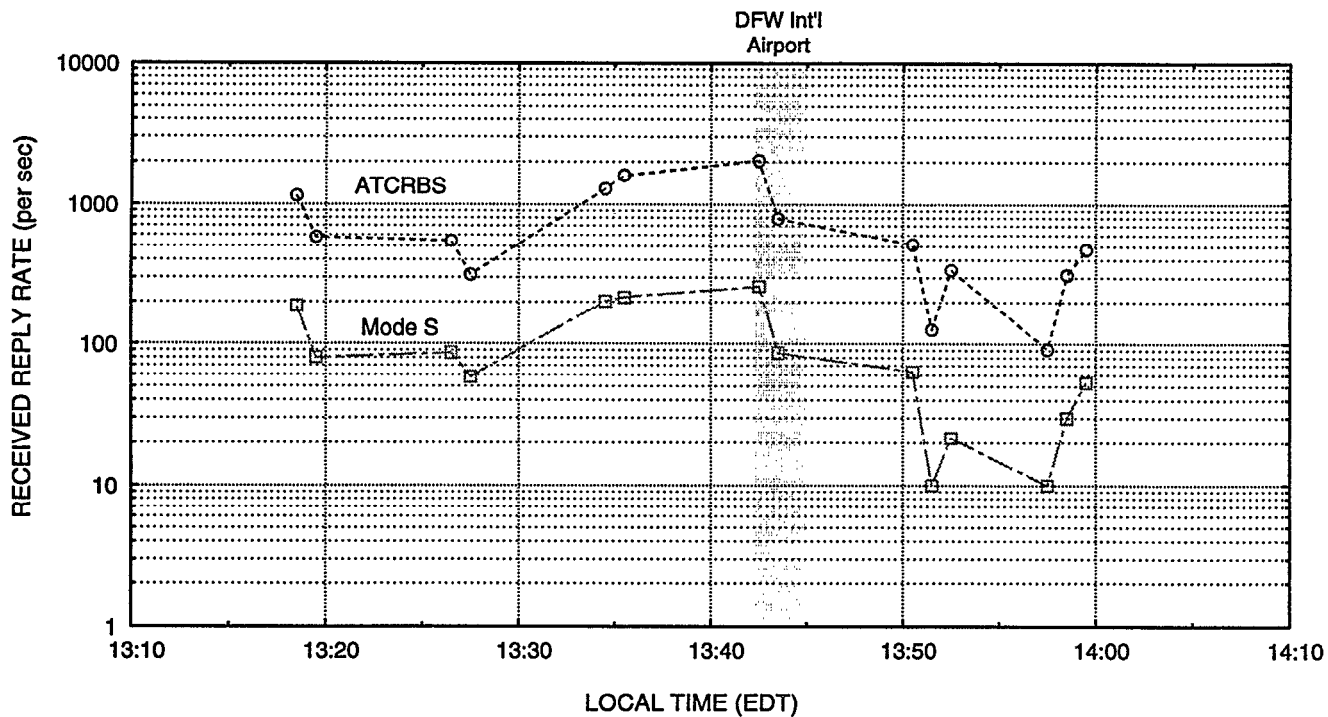

Figure 10. Measured reply rates, Dallas. Measured reply rates in the Dallas area were found to be similar to the behavior seen at the previous locations.

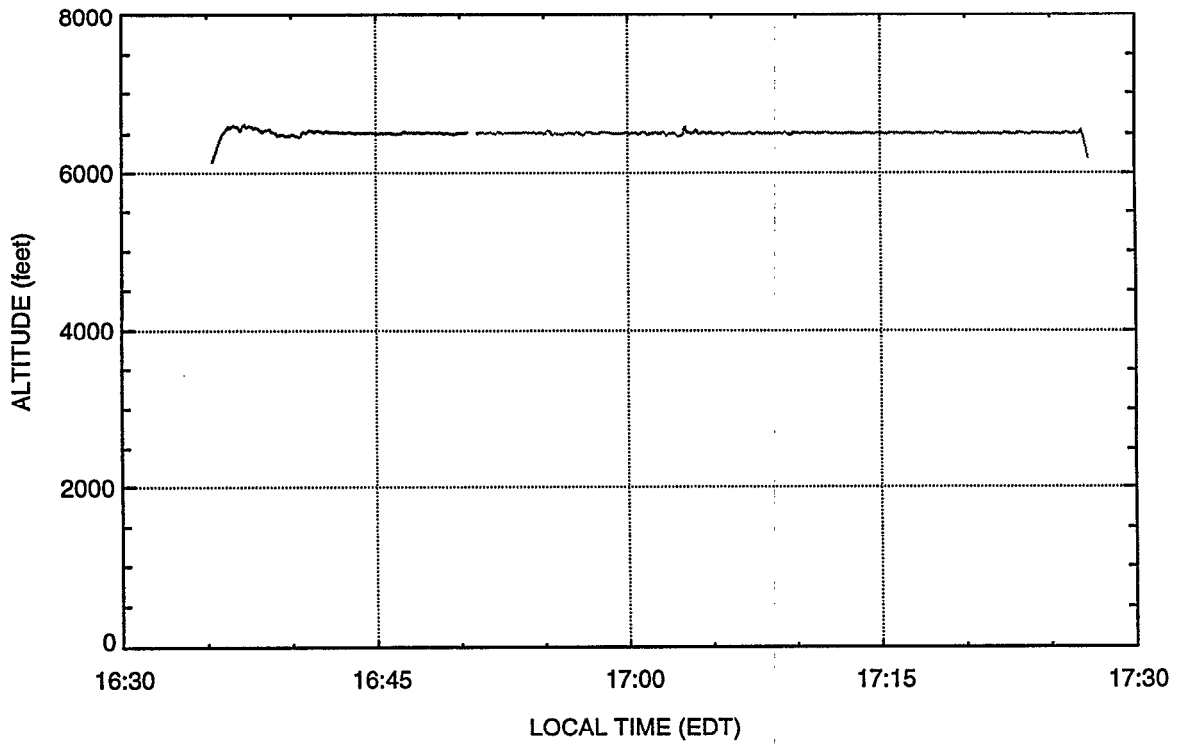
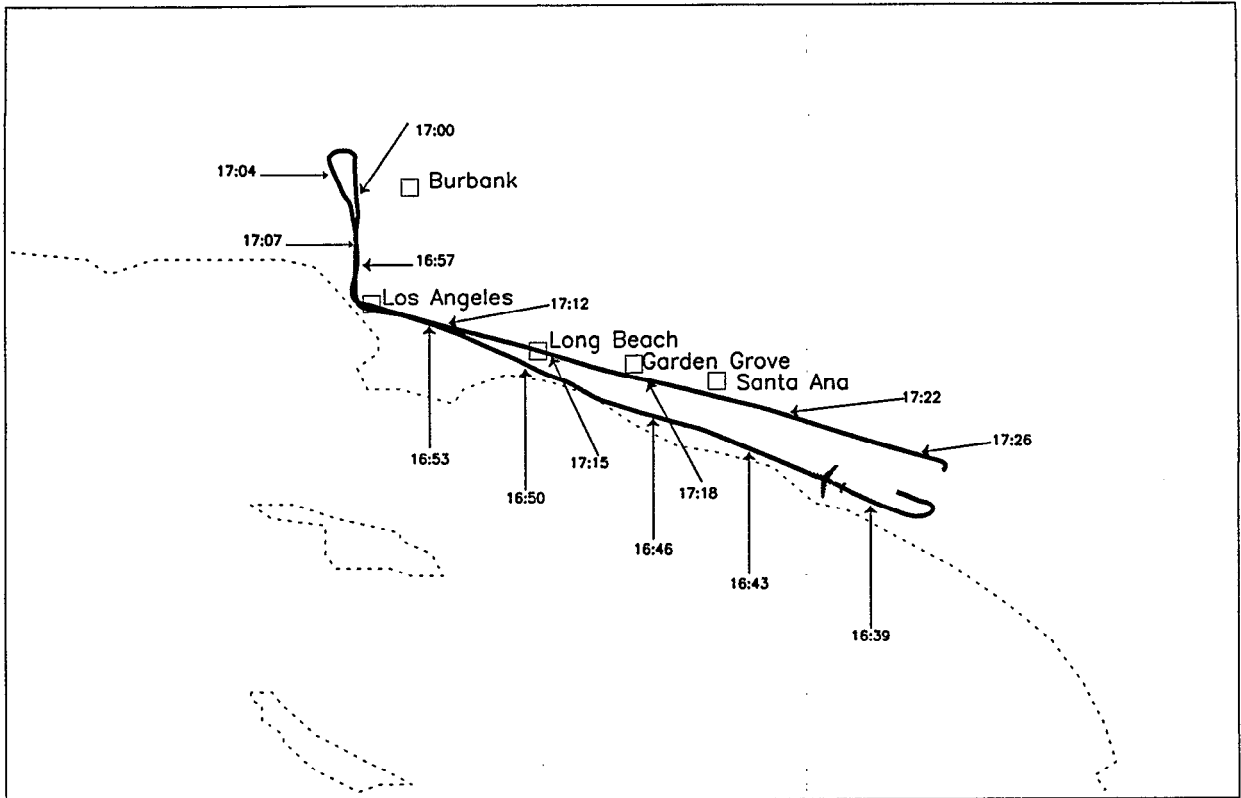

Figure 11. Flight path, Los Angeles Basin. The flight path in the Los Angeles Basin was chosen to pass over Long Beach and LAX, which are considered to be the areas of highest aircraft density.

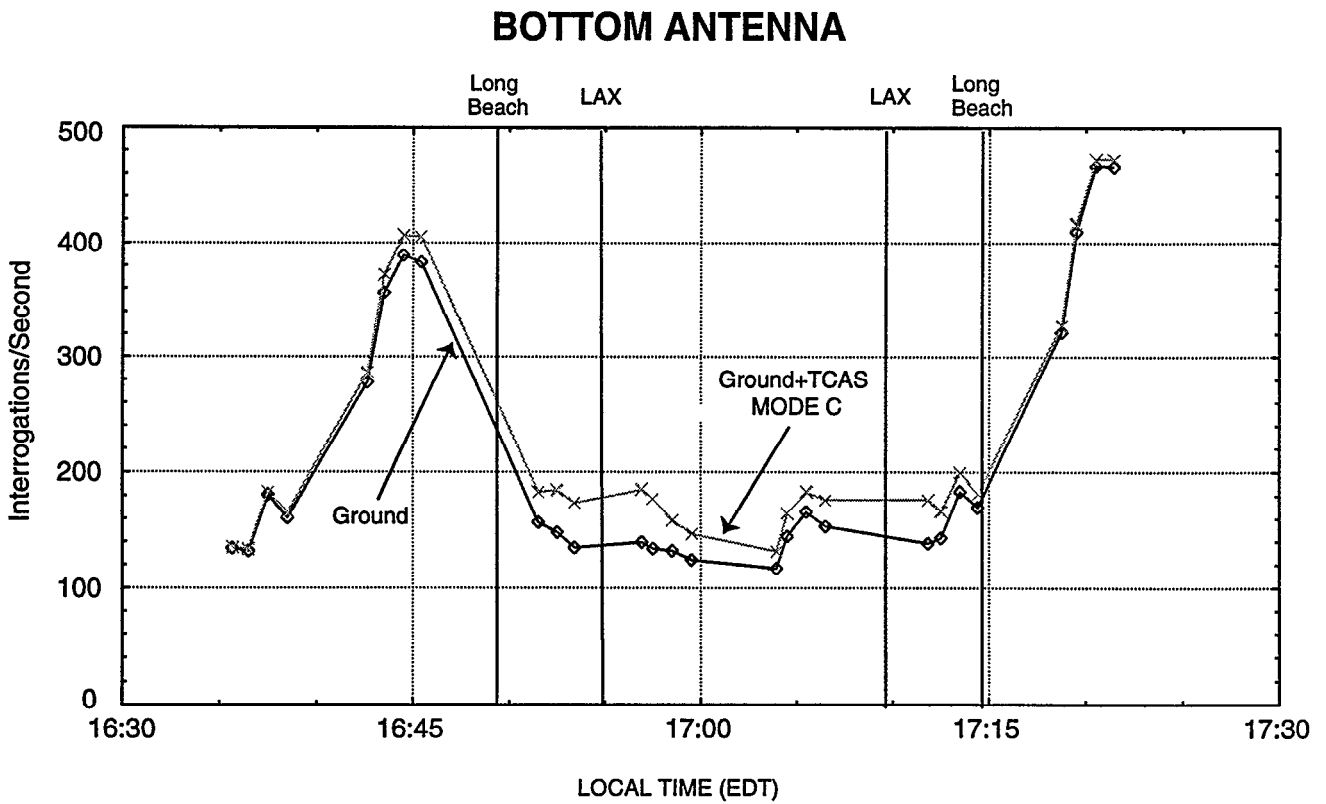
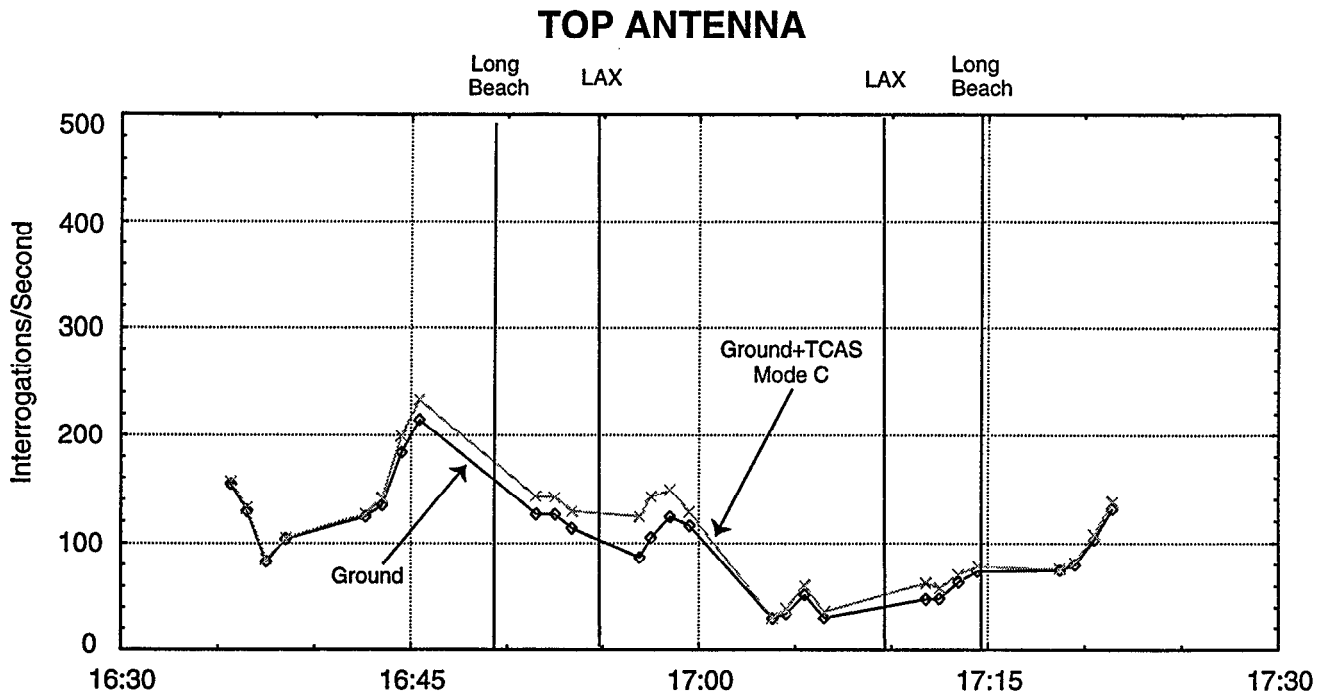
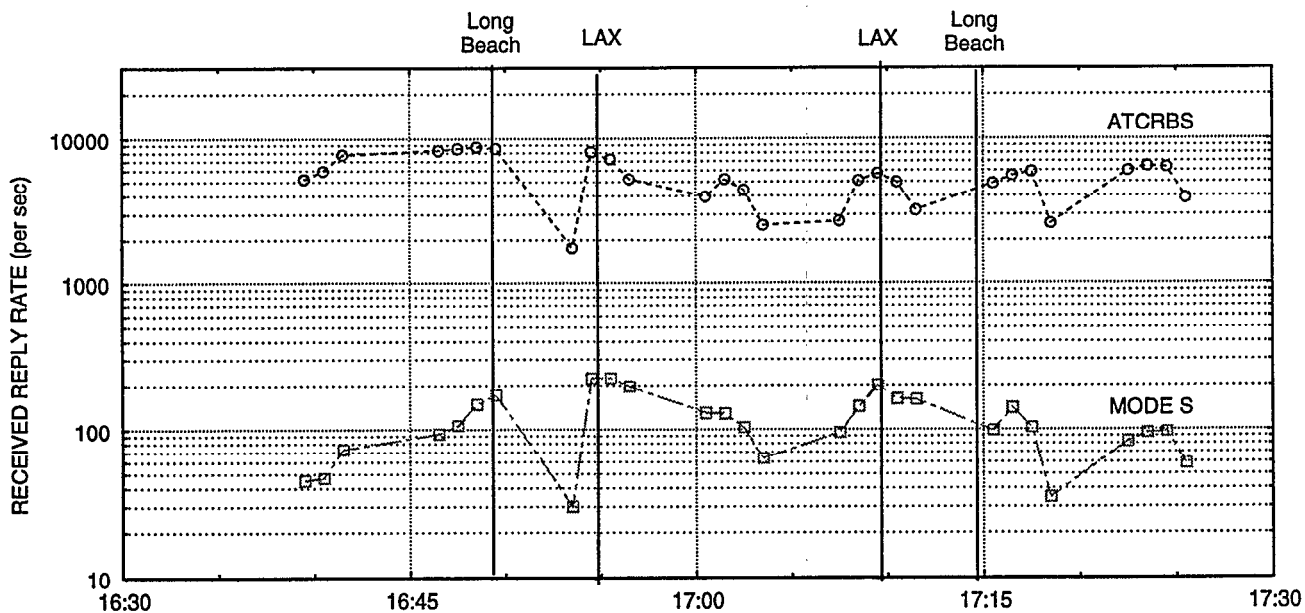

Figure 12. Measured interrogation rates, Los Angeles Basin. The upper curve includes all received ATCRBS interrogations. The lower curve is the subset not including TCAS Mode C interrogations, which are distinguishable by the presence of the P4 pulse [Reference 3]. These results indicate that interrogation rates are high, especially in the vicinity of Long Beach, and that these high rates were transmitted from the ground.

TOP ANTENNA



BOTTOM ANTENNA

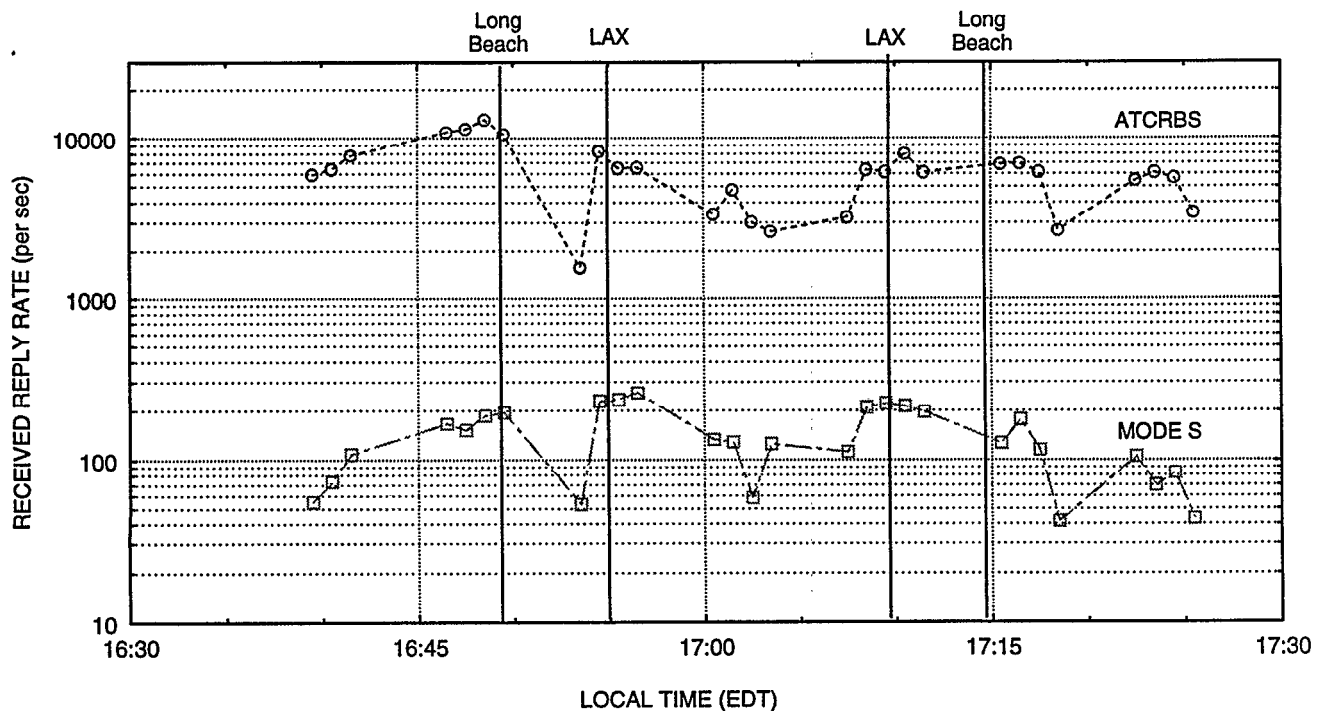

Figure 13. Measured reply rates, Los Angeles Basin. These results indicate that the ATCRBS reply rates are quite high in the Los Angeles Basin, with the maximum in the Long Beach area. These are the highest reply rates seen in any of the locations tested.

3.5 BOSTON

In the spring of 1996, AMF measurements were made in the area west of Boston and in Lakeland Florida. These measurements were done to support testing of air-to-air surveillance equipment, which is affected significantly by the reply-rate environment.

On 15 March 1996, the AMF was flown from Bedford to Gardner and back, recording at 1030 MHz on the westbound leg and recording at 1090 MHz on the return. The flight path for the first leg is shown in Figure 14, and the measured interrogation rates are plotted in Figure 15. The flight path on the return is shown in Figure 16, and the measured reply rates are plotted in Figure 17. The results indicate that throughout most of the flight both the interrogation rates and the reply rates were relatively low compared with the other locations.

3.6 LAKELAND

On 19 March 1996, the AMF was flown in the area of Lakeland, Florida, which is between Tampa and Orlando. Receptions at both 1030 MHz and 1090 MHz were recorded. The flight paths and measured rates are given in the following figures.

- Part A West to east
 - Figure 18 Flight path
 - Figure 19 Measured interrogation rates (1030 MHz)

- Part B East to west and north to south
 - Figure 20 Flight path
 - Figure 21 Measured reply rates (1090 MHz)

- Part C South to north
 - Figure 22 Flight path
 - Figure 23 Measured interrogation rates (1030 MHz)

- Part D West to east
 - Figure 24 Flight path
 - Figure 25 Measured reply rates (1090 MHz)

The results show that the 1030-1090 MHz environment in this area is similar to the environment west of Boston, except perhaps having slightly lower rates.

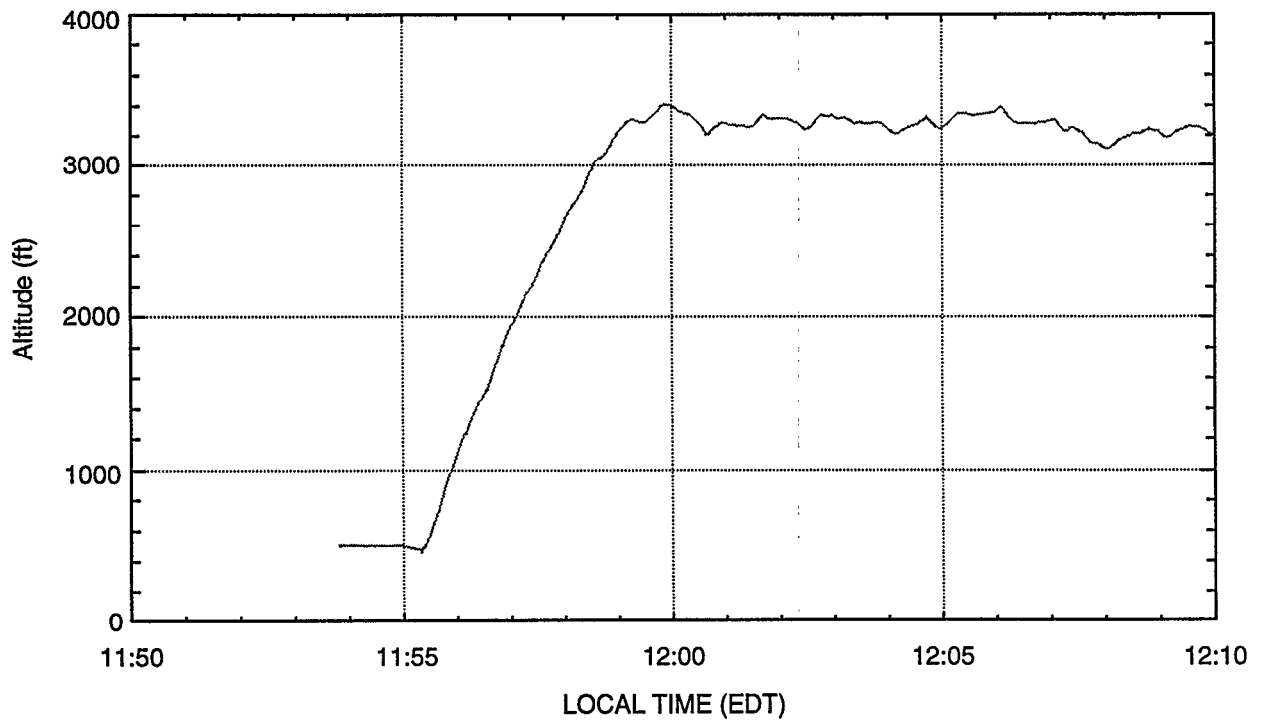
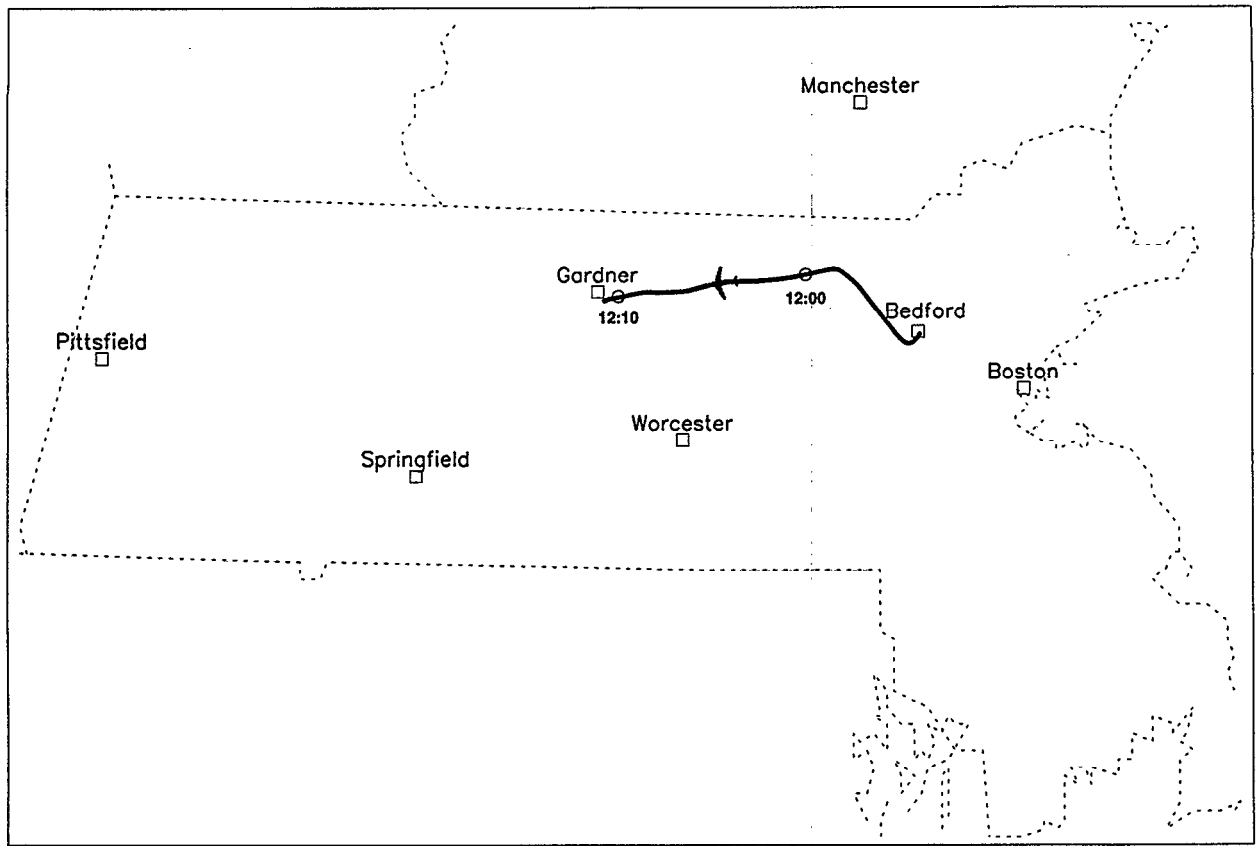

Figure 14. Flight path, Bedford to Gardner. The tests in Massachusetts concentrated in the region northwest of Boston. The first flight segment, shown here, was a measurement of interrogation rates.

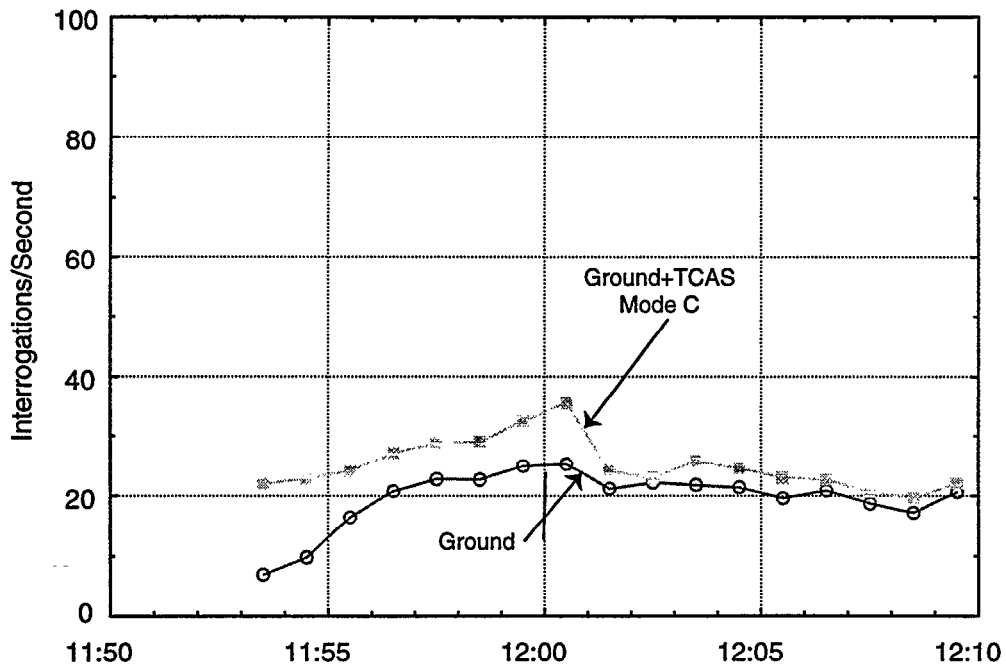
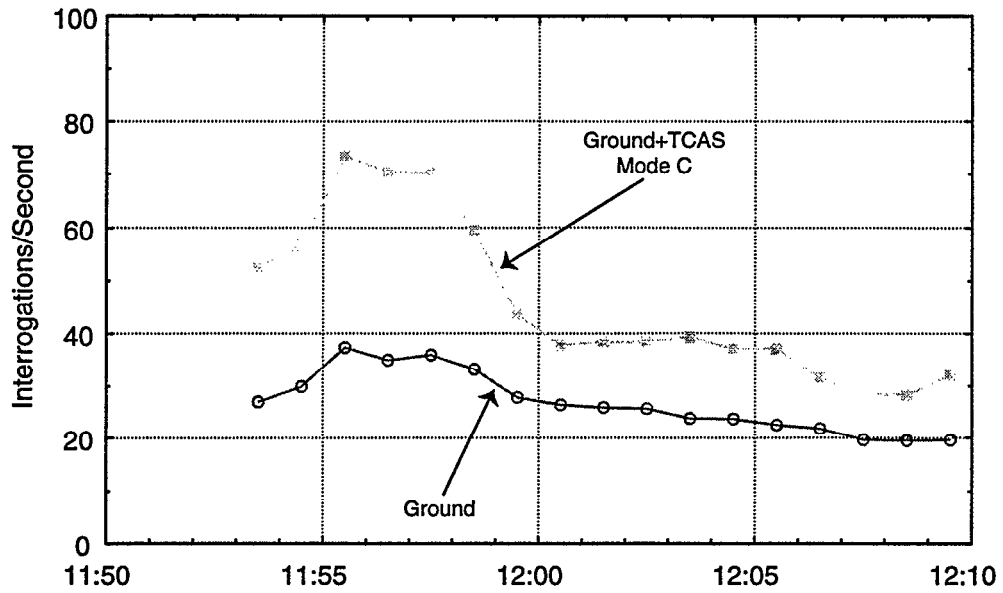

Figure 15. Measured interrogation rates, Bedford to Gardner. As in Figure 12, the upper curve includes all ATCRBS interrogations while the lower curve includes all except TCAS Mode C interrogations. These observed rates are similar to interrogation rates measured in many locations [Reference 3].

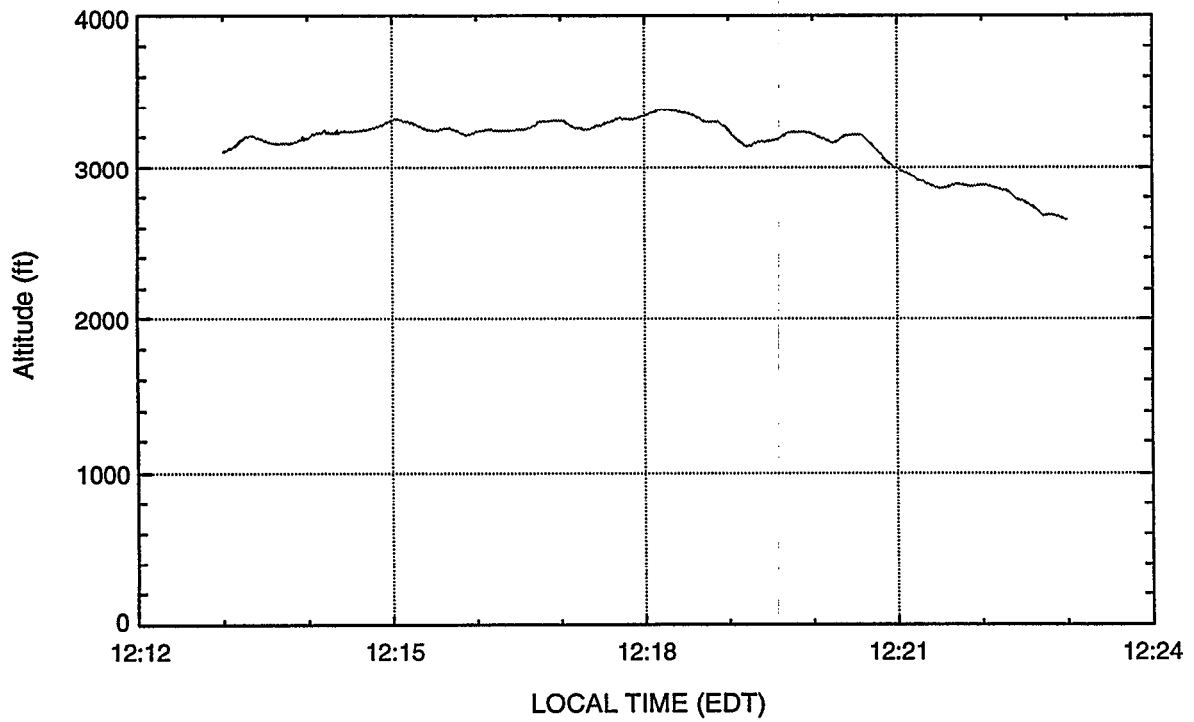
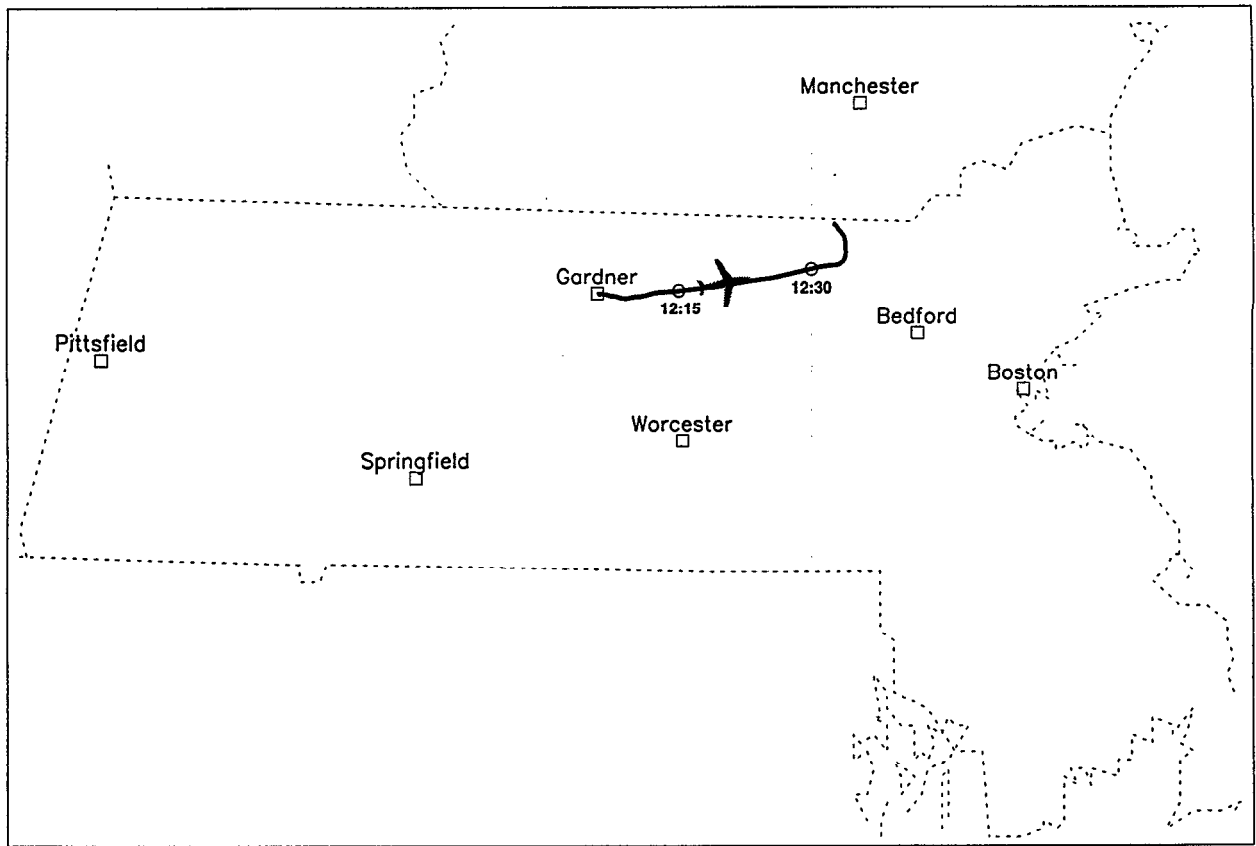
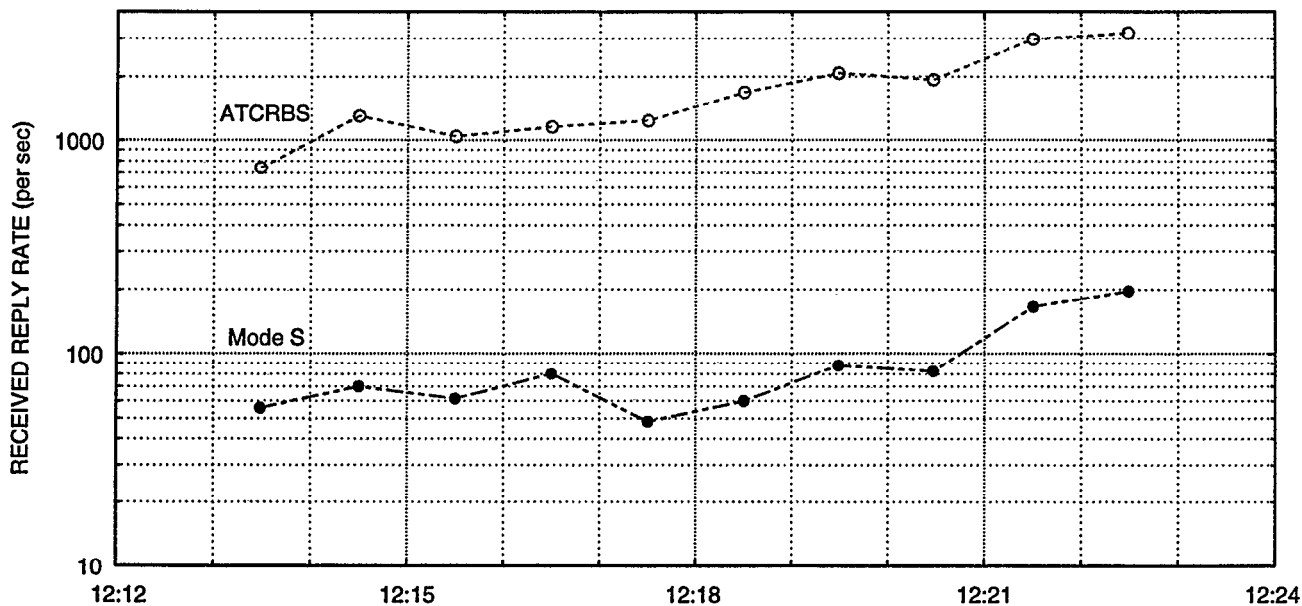

Figure 16. Flight path, Gardner to Bedford. Reply rates were measured while flying on the return path, from Gardner to Bedford, Massachusetts.

TOP ANTENNA



BOTTOM ANTENNA

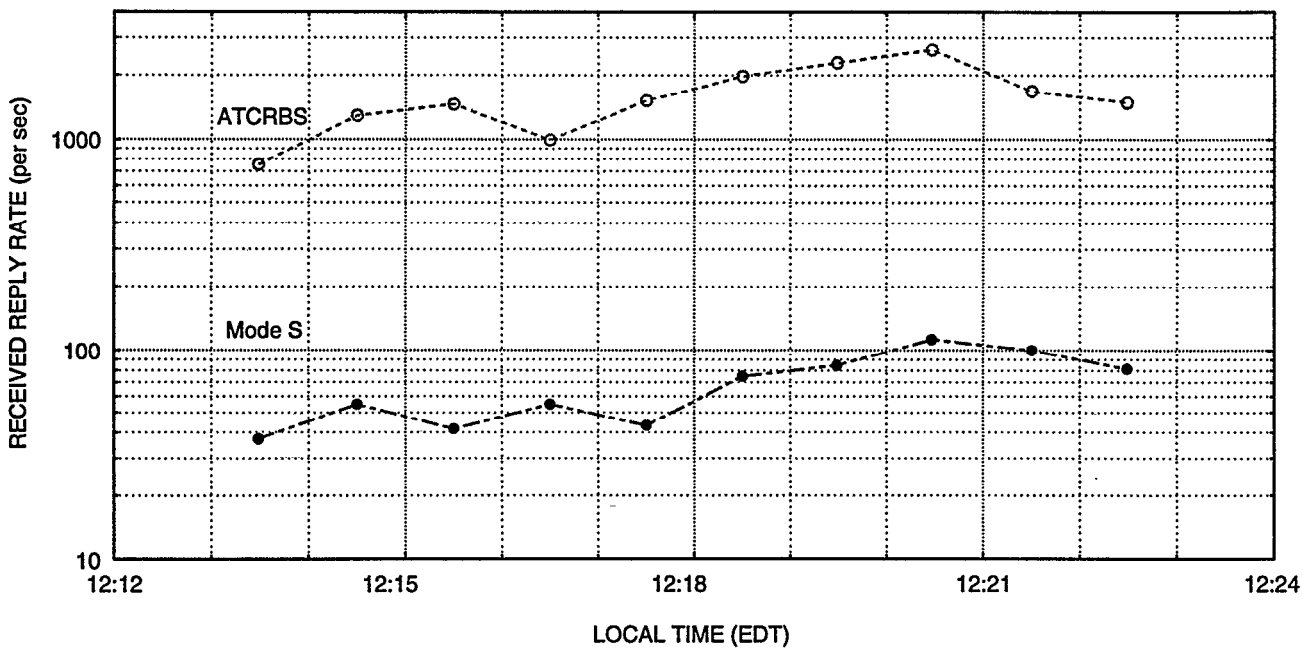

Figure 17. Measured reply rates, Gardner to Bedford. The reply rates observed northwest of Boston were similar to the results seen in the other locations tested. An exception to this is Los Angeles where the reply rates were higher.

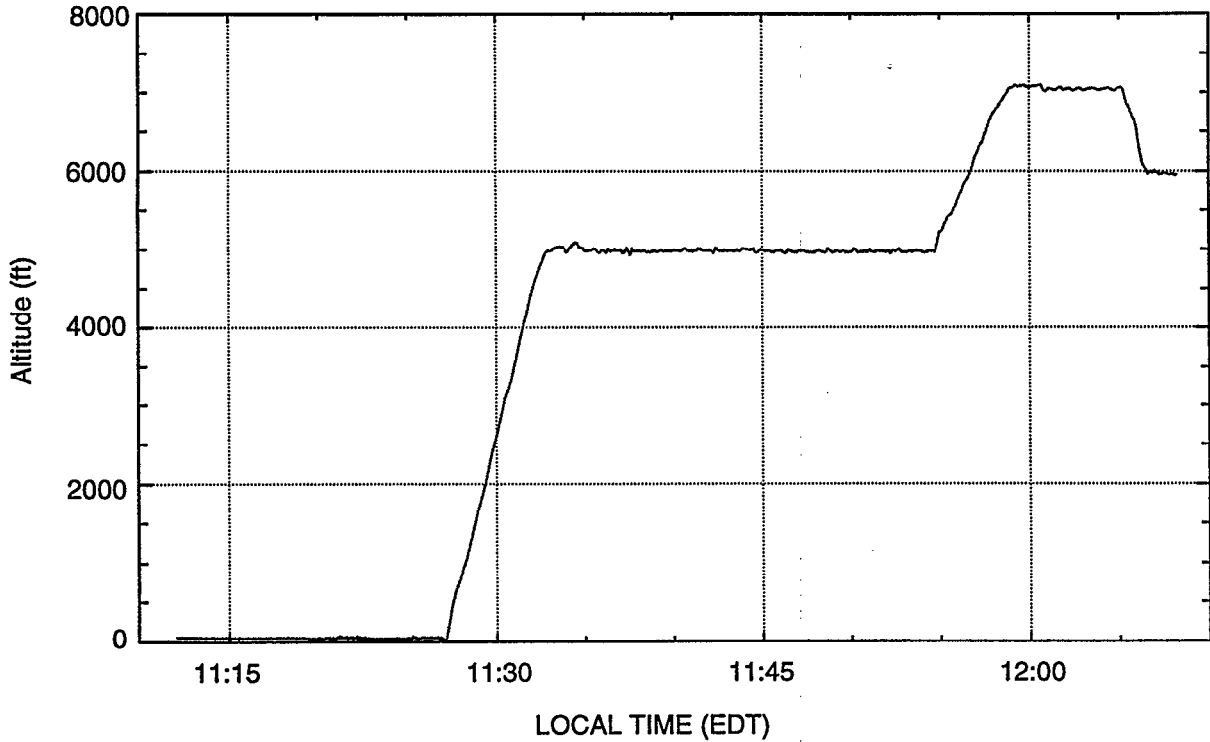
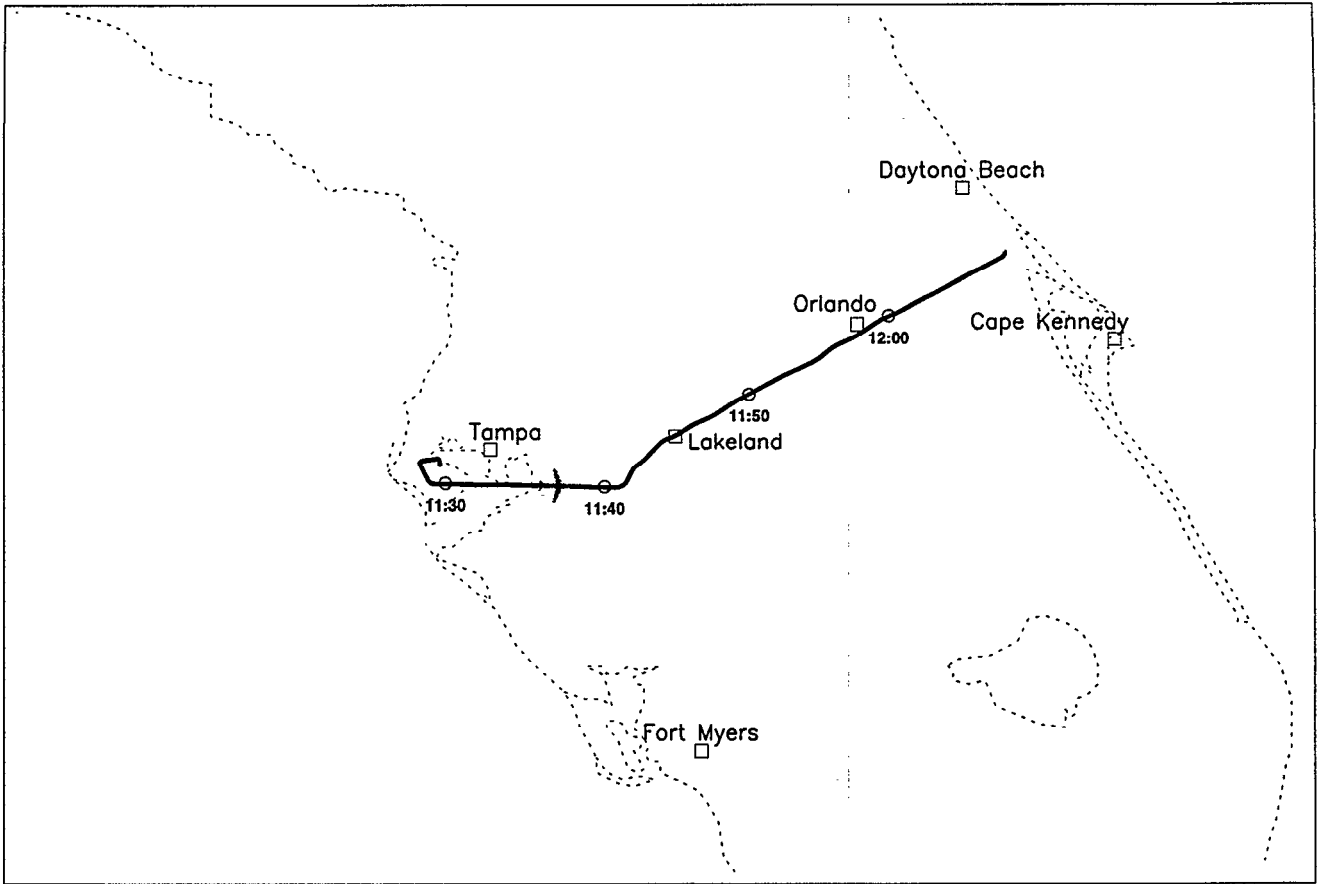
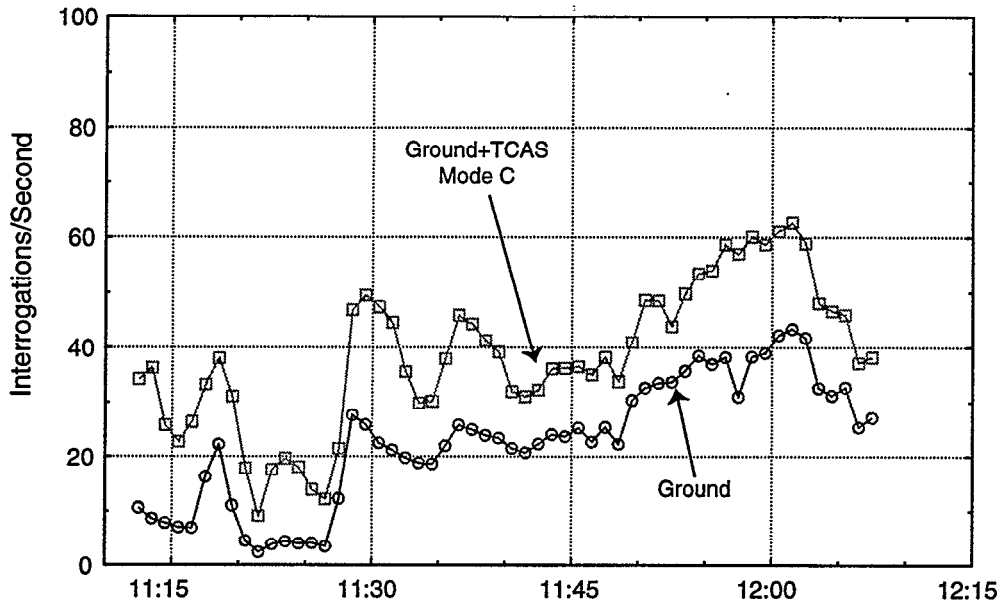

Figure 18. Flight path, Lakeland, part A. This is the first of four flight segments in mid Florida. The AMF aircraft passed over Lakeland and Orlando. Interrogation rates were measured during this segment.

TOP ANTENNA



BOTTOM ANTENNA

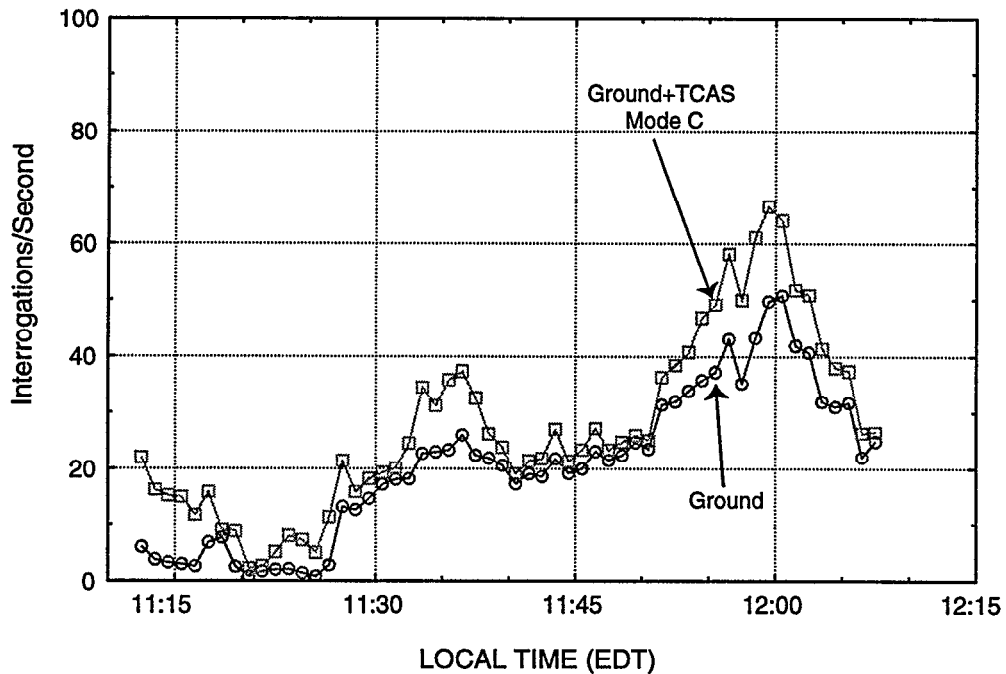

Figure 19. Measured interrogation rates, Lakeland, part A. As in Figure 12, the upper curve includes all ATCRBS interrogations while the lower curve includes all except TCAS Mode C interrogations. These observed rates are similar to interrogation rates measured in many locations [Reference 3].

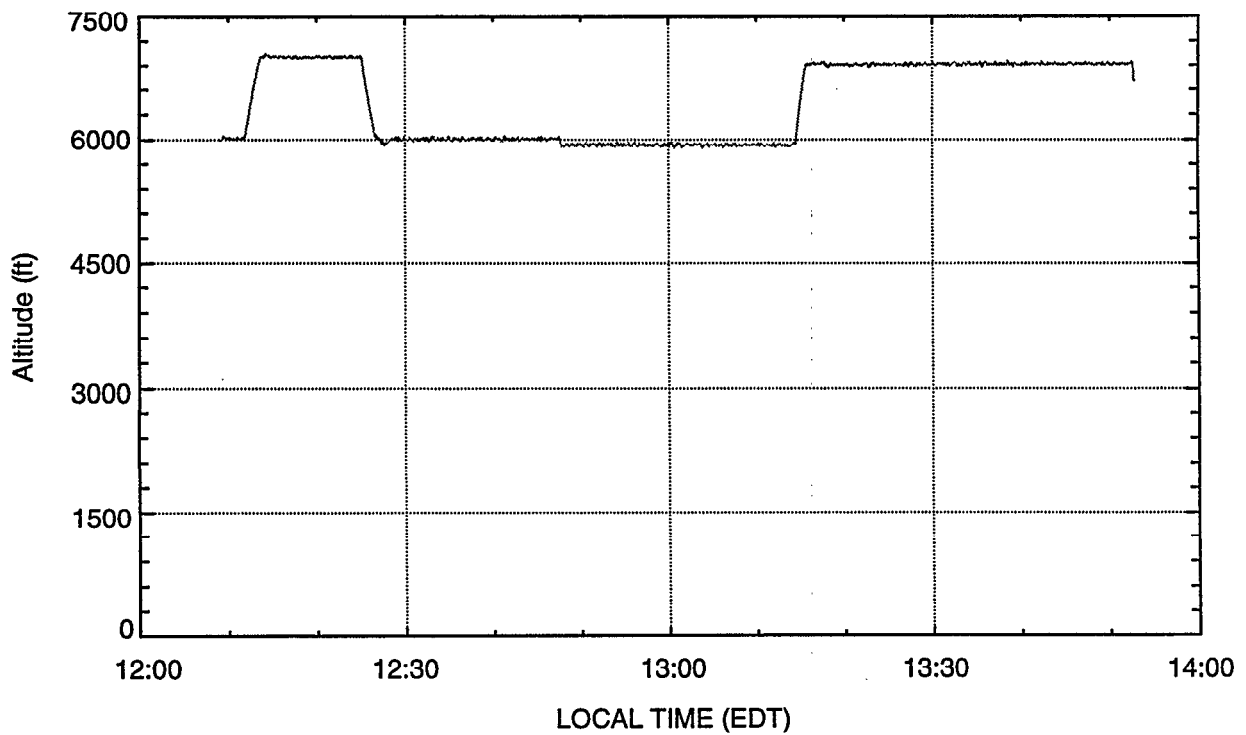
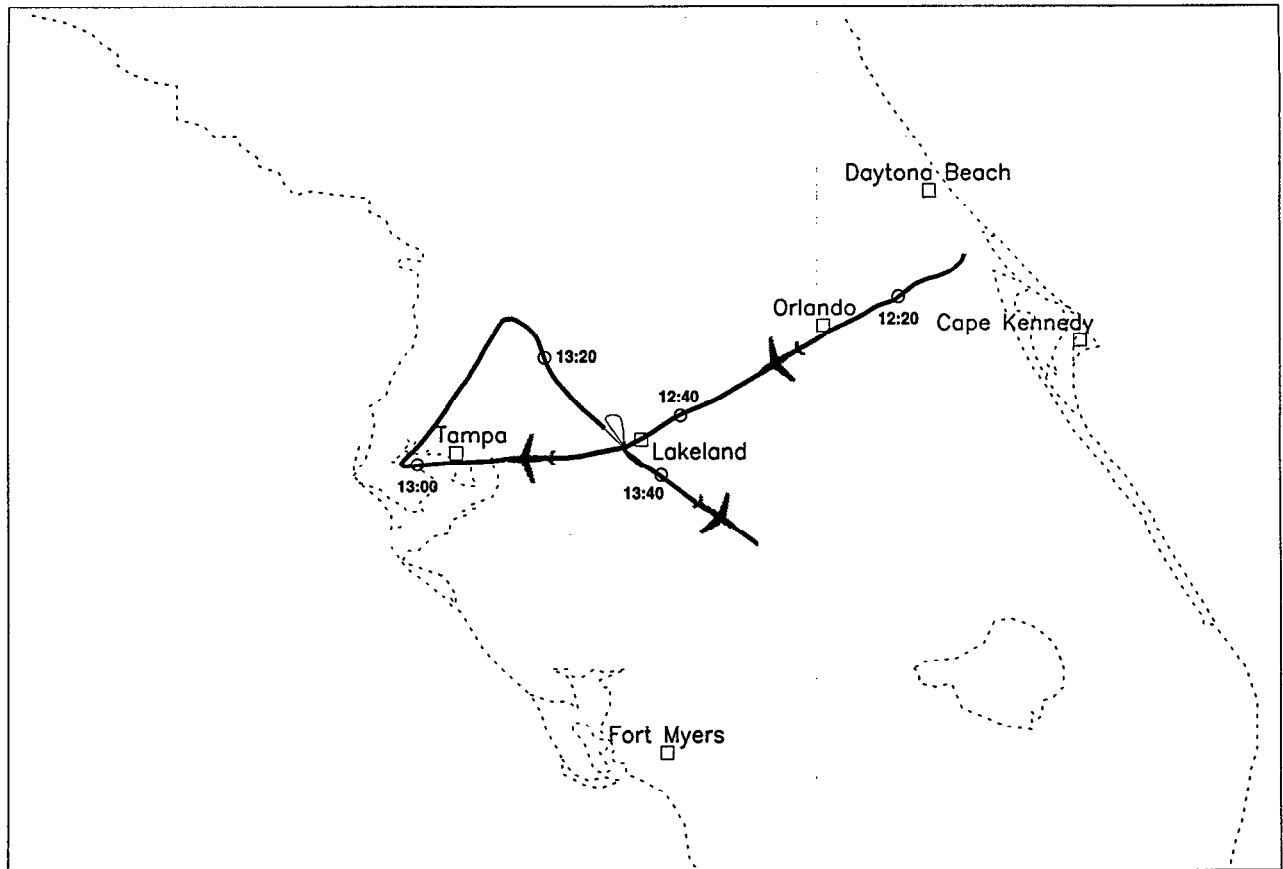
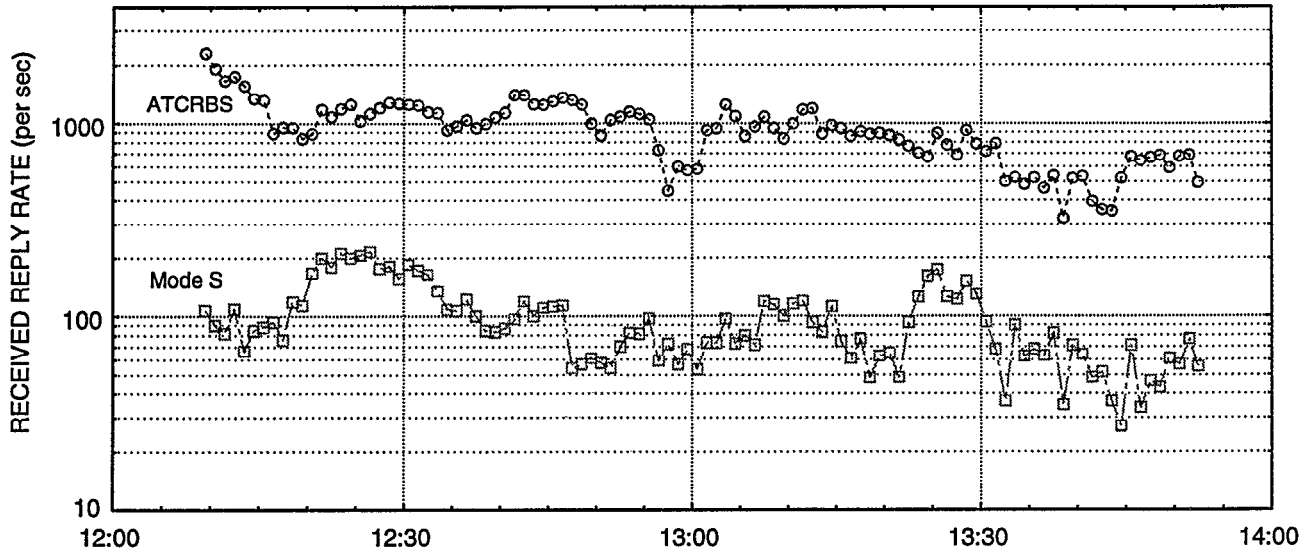

Figure 20. Flight path, Lakeland, part B. In the second segment, the AMF aircraft flew back across Florida, again passing over Orlando and Lakeland, and continuing on to Tampa. The flight continued by flying north and then southbound flying over Lakeland again. Reply rates were measured during this segment.

TOP ANTENNA



BOTTOM ANTENNA

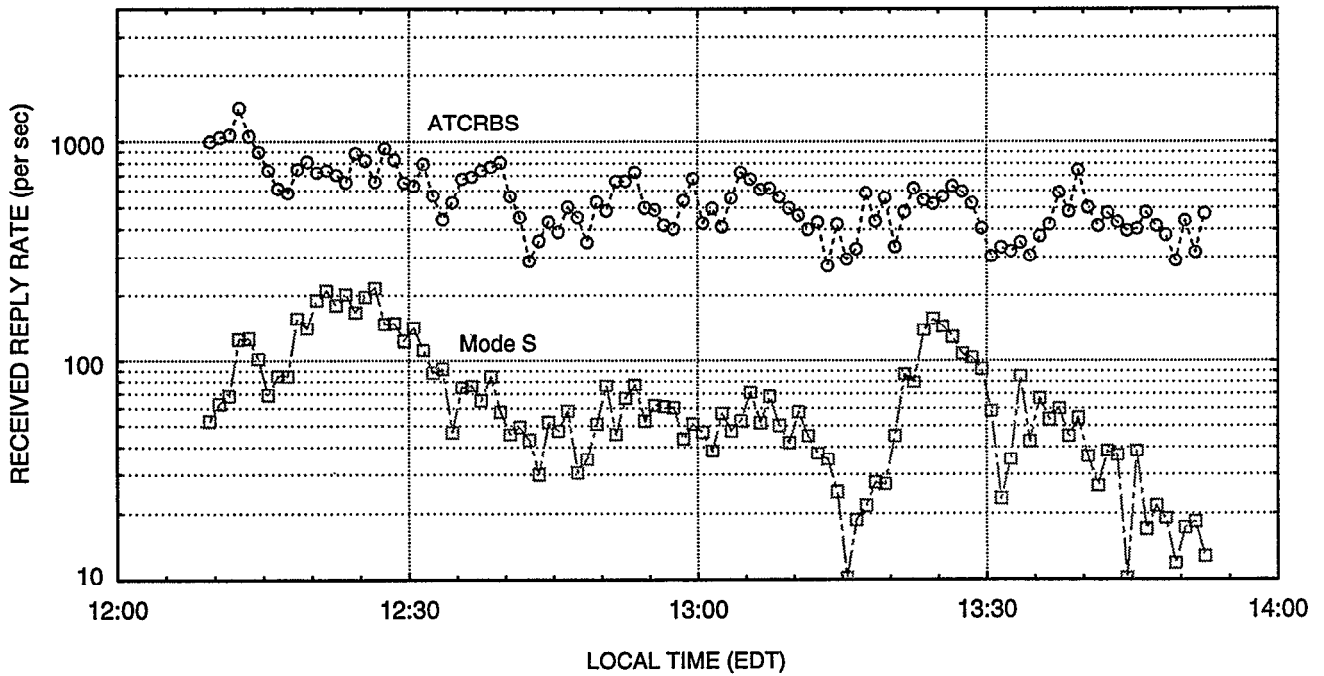

Figure 21. Measured reply rates, Lakeland, part B. The measured reply rates in mid-Florida were found to be somewhat lower than in most of the other locations tested.

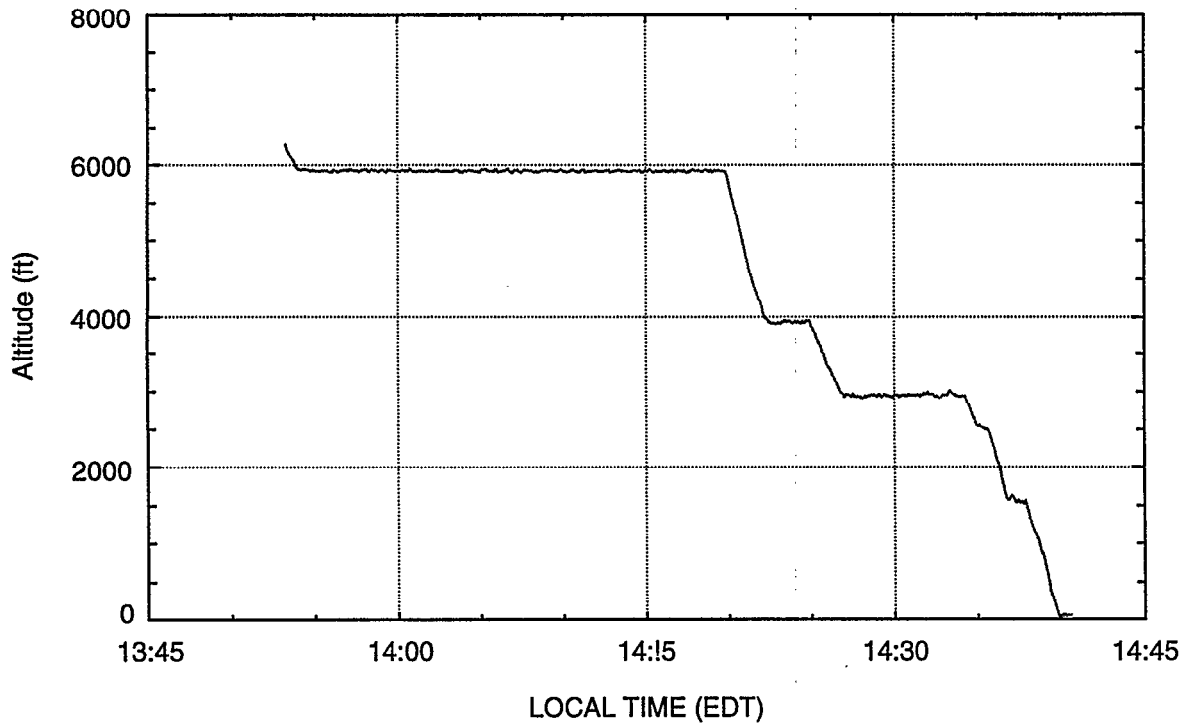
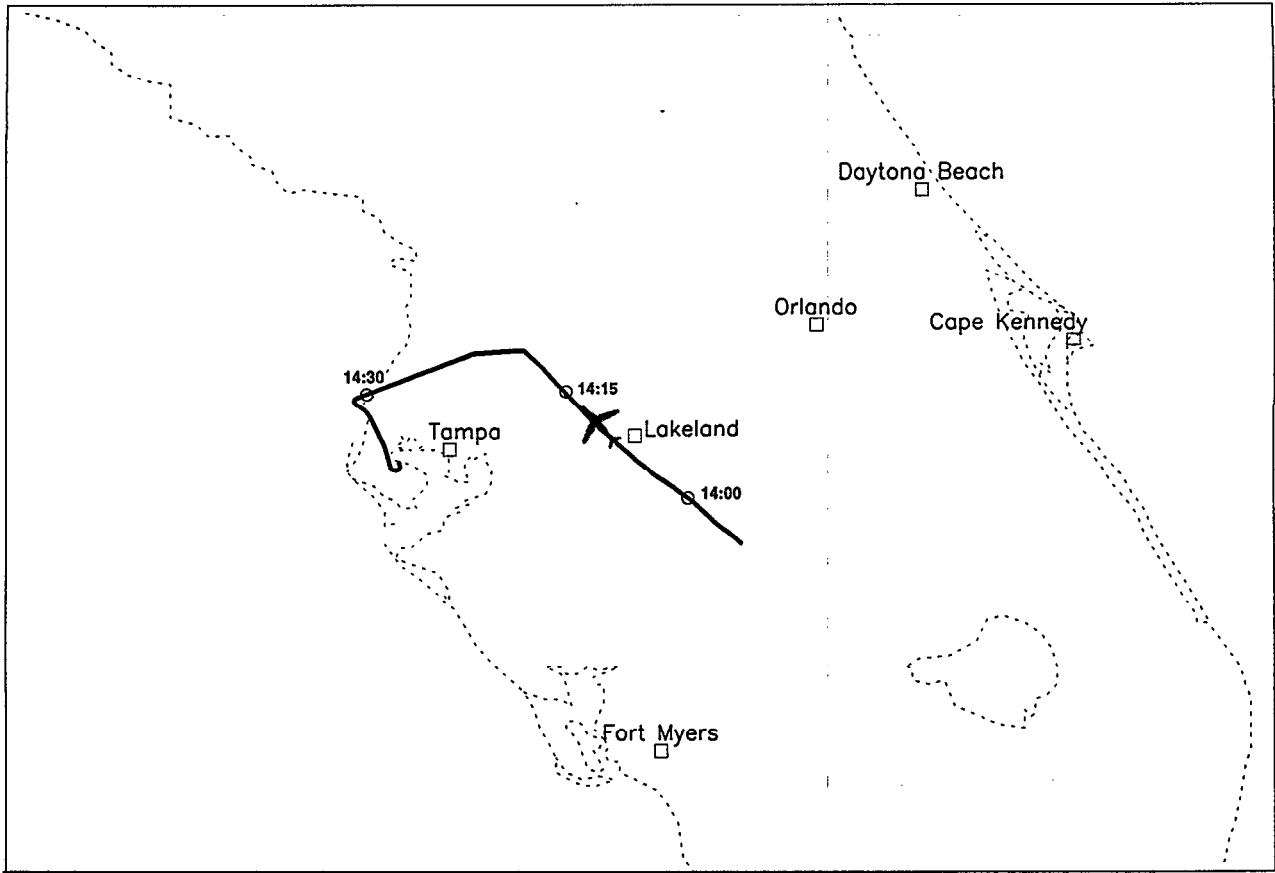
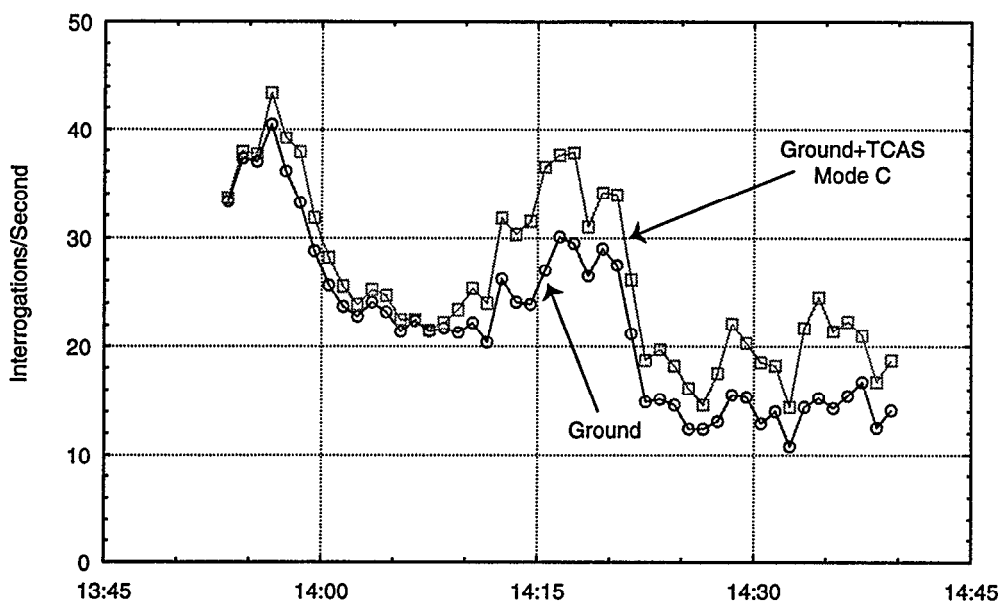

Figure 22. Flight path, Lakeland, part C. In the third segment, the AMF aircraft flew back over Lakeland, and then west toward the Gulf coast. Interrogation rates were measured during this segment.

TOP ANTENNA



BOTTOM ANTENNA

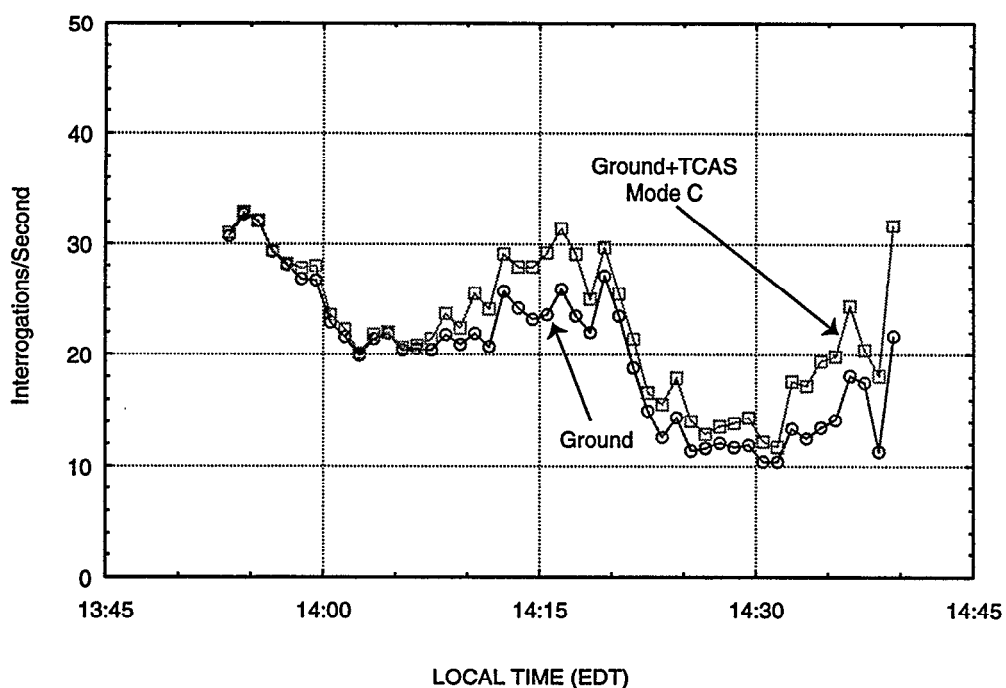

Figure 23. Measured interrogation rates, Lakeland, part C. As in Figure 12, the upper curve includes all ATCRBS interrogations while the lower curve includes all except TCAS Mode C interrogations. These results are similar to previous results except somewhat lower. Comparing these results with the interrogation rates made 2 hours earlier in Figure 19, it is seen that the rates have reduced.

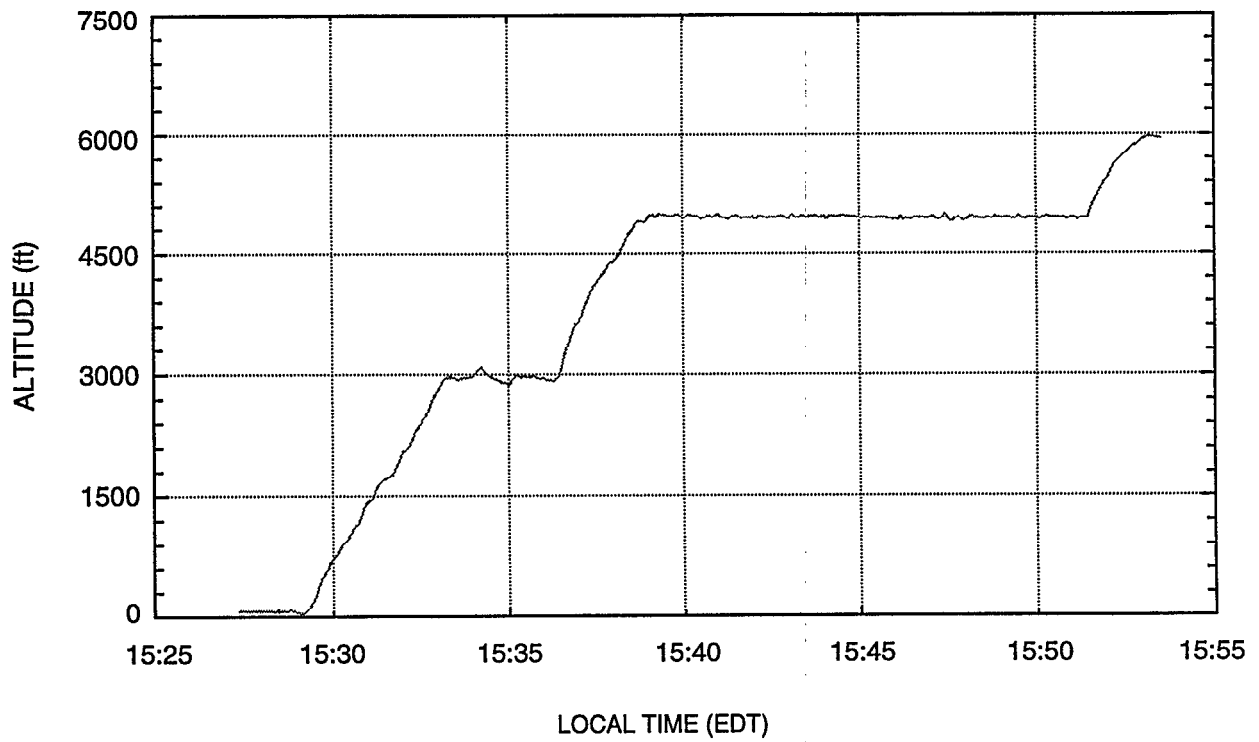
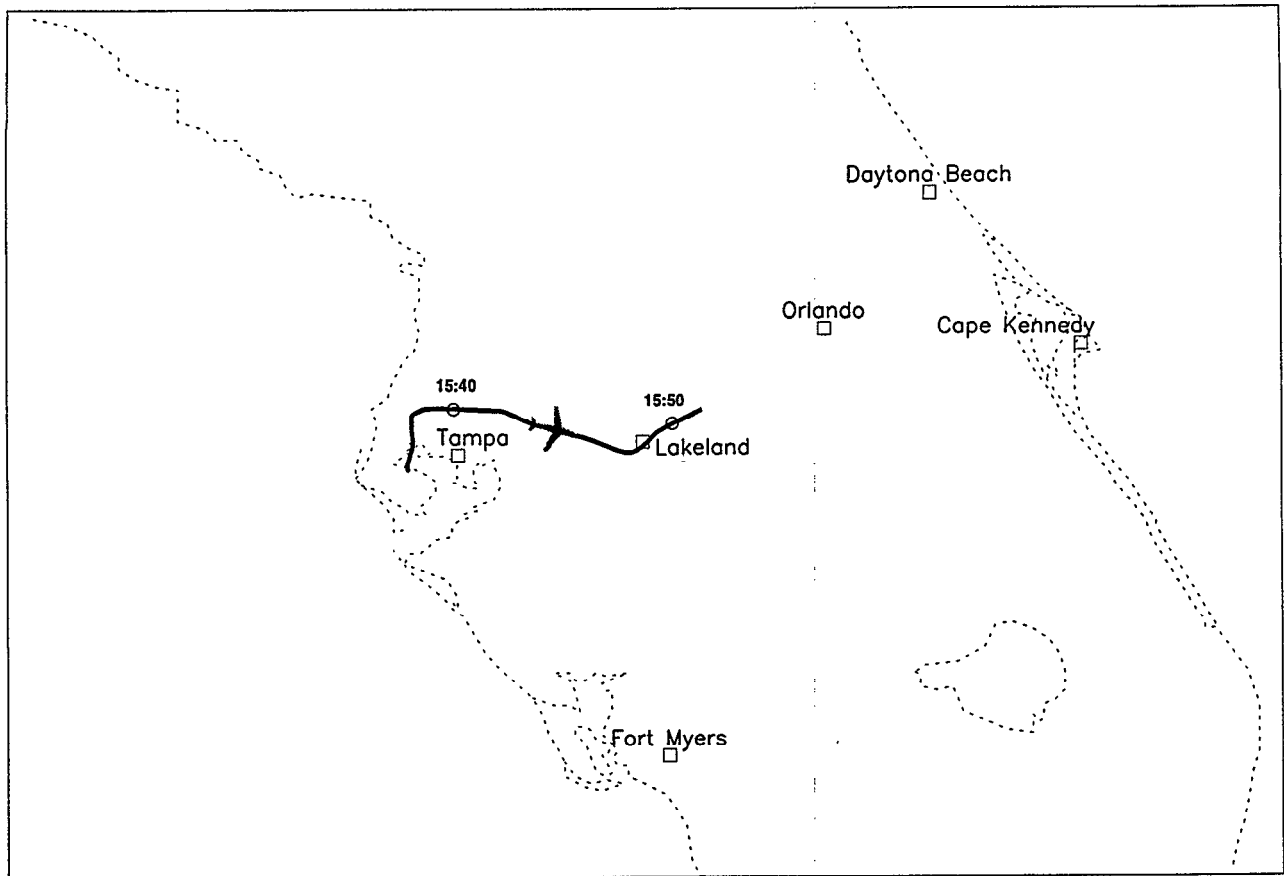
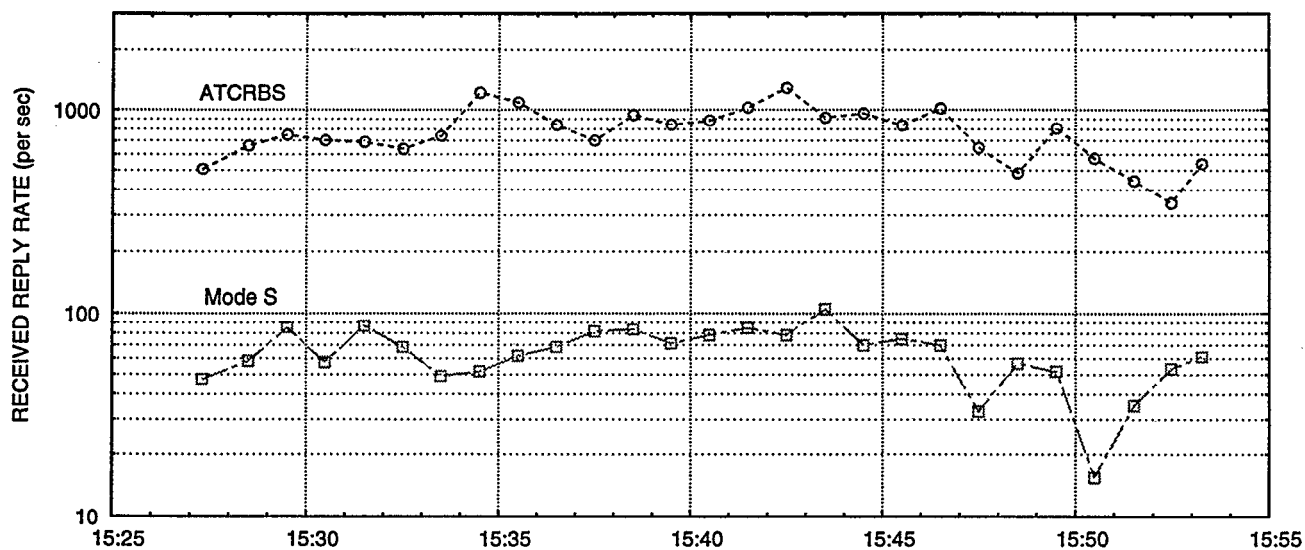

Figure 24. Flight path, Lakeland, part D. In the fourth segment, the AMF aircraft flew west to east over Lakeland. Reply rates (Figure 25) were measured during this segment.

TOP ANTENNA



BOTTOM ANTENNA

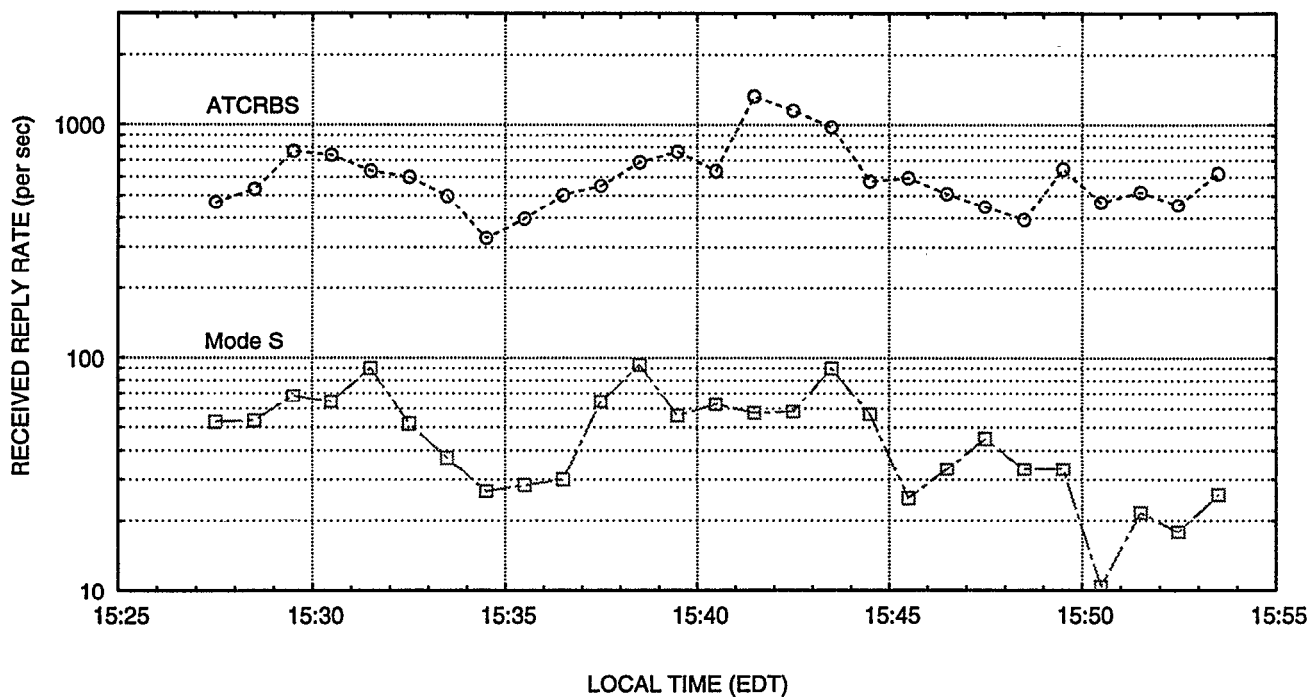
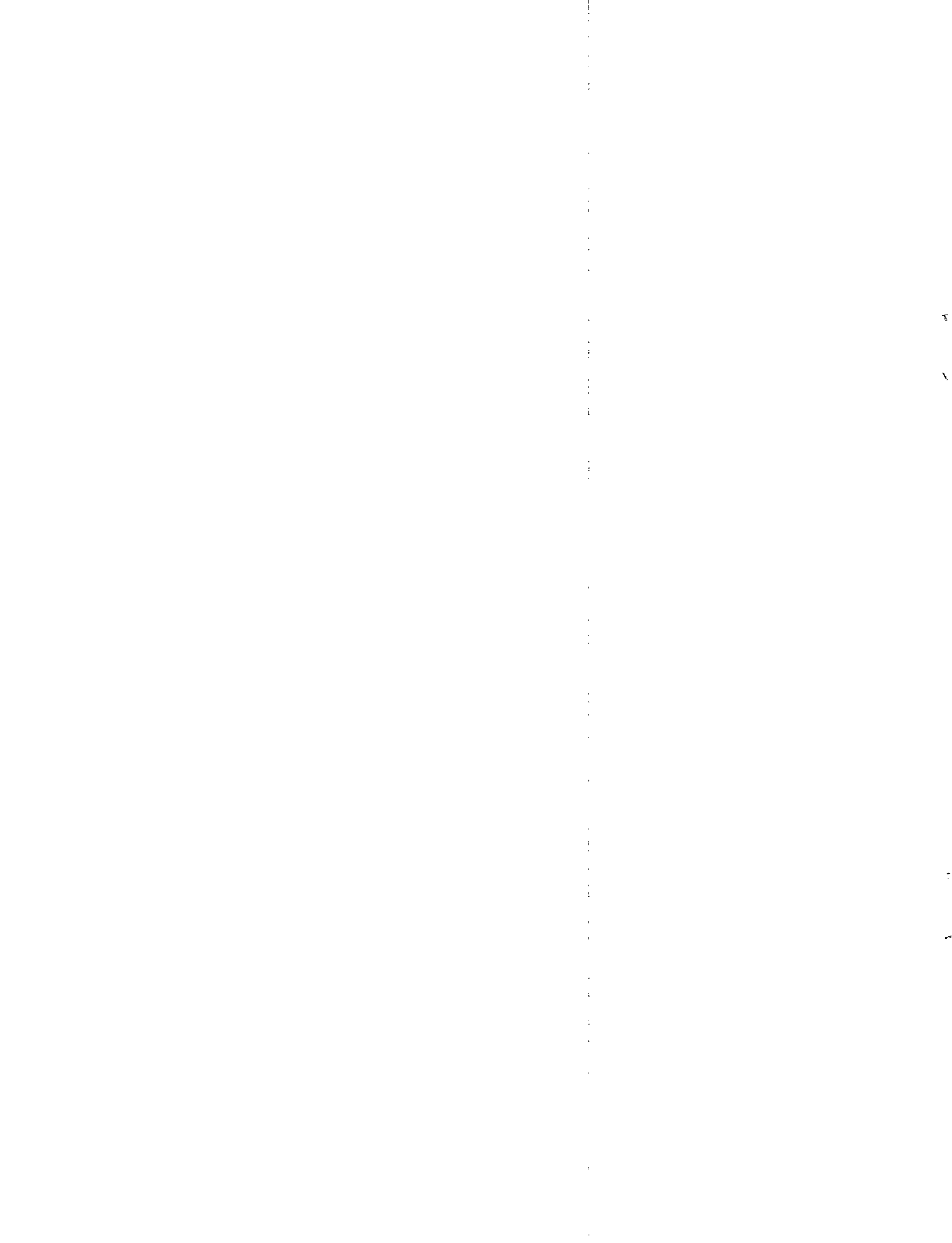

Figure 25. Measured reply rates, Lakeland, part D. These results are similar to the reply rates measured previously in this area (Figure 21).



4. CONCLUSIONS

Flights of the AMF aircraft have successfully measured the reply-rate environments in New York, Philadelphia, Atlanta, Dallas, Los Angeles, Boston, and Lakeland. The results have been compared with calculated values and with previous measurements.

Mode S reply rates are seen to be much lower than ATCRBS reply rates. This difference would be expected given that Mode S ground stations were not yet operating at the time of most of these measurements, and based on the fact that an ATCRBS ground station elicits a large number of Mode A and C replies in making a single azimuth measurement.

The airborne equipment included a capability to measure the received power level of each reception. This capability was used to generate results giving reception rate as a function of receiver threshold. The resulting characteristics were found to agree with a "uniform-in-range model," which would be appropriate in the metropolitan areas in which this data was recorded.

The absolute rates of received replies have been compared with calculated values, obtained by multiplying the number of aircraft and the average reply rate of a single aircraft. Both factors are variable, so measurements of received reply rate are expected to be quite variable. Nevertheless, the degree of consistency between these calculations and the measurements provides some confidence that the measurements are valid and that the understanding of the underlying mechanisms is correct.

Comparisons have also been made between these measurements and similar measurements made in 1978. The results indicate there have not been major changes in the 1090 MHz environment during this time, although there appears to be a relatively minor trend of decreasing reply rates in New York and Philadelphia, and a relatively minor trend of increasing rates in Los Angeles.

The principal conclusion is that these airborne measurements are generally consistent with expectations and previous measurements, and can serve as a basis for interference analysis in the GPS-Squitter development program.

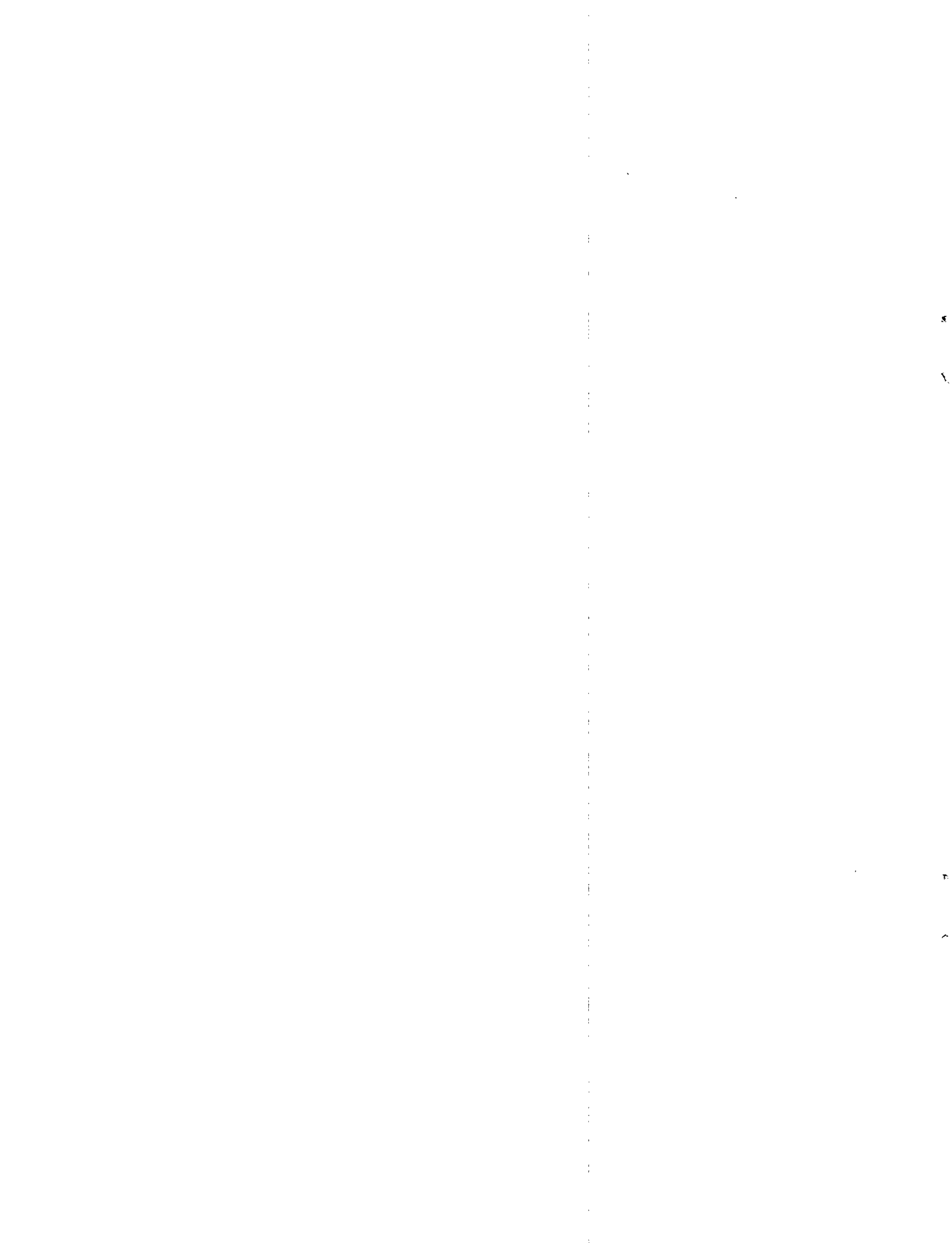

REFERENCES

- [1] V. A. Orlando, G. H. Knittel, R. E. Boisvert, *GPS-Squitter: System Concept, Performance, and Development Program*, Lincoln Laboratory Journal, Volume 7, Number. 2 (Fall 1994) pp. 271-294.
- [2] V. A. Orlando and W. H. Harman, "GPS-Squitter Capacity Analysis," Project Report ATC-214, Lincoln Laboratory, M.I.T., (20 May 1994)
- [3] W. H. Harman and M. J. Brennan, "Beacon Radar and TCAS Interrogation Rates: Airborne Measurements in the 1030 MHz Band," Project Report ATC-239, Lincoln Laboratory, M.I.T. (2 May 1996).
- [4] W. H. Harman, "Airborne Measurements of ATCRBS Fruit," Project Report ATC-84, Lincoln Laboratory, M.I.T. (3 October 1978).
- [5] G. V. Colby, "The Airborne Measurement Facility (AMF) System Description," Project Report ATC-60, Lincoln Laboratory, M.I.T., (25 March 1976).
- [6] S. I. Altman and P. M. Daly, "The Enhanced Airborne Measurement Facility Recording System," Project Report ATC-228, Lincoln Laboratory, M.I.T., (31 January 1995).
- [7] W. H. Harman, "Effects of RF Power Deviations on BCAS Link Reliability," Project Report ATC-76, Lincoln Laboratory, M.I.T., (7 June 1977).
- [8] W. H. Harman, "Air Traffic Density and Distribution Measurements," Project Report ATC-80, Lincoln Laboratory, M.I.T., (3 May 1979).