

**Project Report  
ATC-372**

**Lincoln Laboratory  
1030/1090 MHz Monitoring  
March–June 2010**

**B.J. Chludzinski  
A.C. Drumm  
T.R. Elder  
W.H. Harman  
G.S. Harris  
A.D. Panken**

**15 November 2011**

---

**Lincoln Laboratory**  
MASSACHUSETTS INSTITUTE OF TECHNOLOGY  
*LEXINGTON, MASSACHUSETTS*

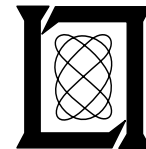

Prepared for the Federal Aviation Administration,  
Washington, D.C. 20591

This document is available to the public through  
the National Technical Information Service,  
Springfield, Virginia 22161

This document is disseminated under the sponsorship of the Department of Transportation, Federal Aviation Administration, in the interest of information exchange. The United States Government assumes no liability for its contents or use thereof.

TECHNICAL REPORT STANDARD TITLE PAGE

1. Report No. ATC-372	2. Government Accession No.	3. Recipient's Catalog No.	
4. Title and Subtitle Lincoln Laboratory 1030/1090 MHz Monitoring March-June 2010		5. Report Date 15 November 2011	
		6. Performing Organization Code	
7. Author(s) Barbara J. Chludzinski, Ann C. Drumm, Tomas R. Elder, William H. Harman, Garrett S. Harris, and Adam D. Panken		8. Performing Organization Report No. ATC-372	
9. Performing Organization Name and Address MIT Lincoln Laboratory 244 Wood Street Lexington, MA 02420-9108		10. Work Unit No. (TRAIS)	
		11. Contract or Grant No. FA8721-05-C-0002	
12. Sponsoring Agency Name and Address Department of Transportation Federal Aviation Administration 800 Independence Ave., S.W. Washington, DC 20591		13. Type of Report and Period Covered Project Report	
		14. Sponsoring Agency Code	
15. Supplementary Notes  This report is based on studies performed at Lincoln Laboratory, a center for research operated by Massachusetts Institute of Technology, under Air Force Contract FA8721-05-C-0002.			
16. Abstract  Traffic Alert and Collision Avoidance System (TCAS) behavior in New England airspace is being monitored and analyzed, making use of an omni-directional 1030/1090 MHz receiver. The receiver system, located in Lexington, Massachusetts, and operated by MIT Lincoln Laboratory, is used to record data for subsequent analysis in non-real-time. This is the second report of MIT Lincoln Laboratory 1030/1090 MHz monitoring, covering the period March through June 2010.  There are three main areas of study:  1. 1030 MHz data related to TCAS air-to-air coordination and other communications, 2. 1030 and 1090 MHz data related to TCAS surveillance, and 3. 1090 MHz Extended Squitter data, i.e., the Mode S implementation of Automatic Dependent Surveillance-Broadcast (ADS-B).  In addition to a summary of results, this report answers specific questions raised during the previous 2009 analysis and attempts to provide insights into the meaning of the data with respect to TCAS operation.  This four-month period will be used to baseline 1030/1090 MHz activity in the New England area. Future plans call for the 1030/1090 MHz receiver to be moved so that limited data recording can be performed at various TCAS RA Monitoring System (TRAMS) sites throughout the NAS.			
17. Key Words  TCAS, monitoring, 1030 MHz, 1090 MHz, air-to-air coordination, Extended Squitter, TCAS surveillance, reception rate		18. Distribution Statement  This document is available to the public through the National Technical Information Service, Springfield, VA 22161.	
19. Security Classif. (of this report)  Unclassified	20. Security Classif. (of this page)  Unclassified	21. No. of Pages  74	22. Price

This page intentionally left blank.

## ACKNOWLEDGMENTS

The authors would like to thank Neal Suchy, FAA TCAS Program Manager, who is responsible for overseeing the Lincoln Laboratory TCAS work. It is because of his vision that the 1030/1090 MHz monitoring is taking place.

We would also like to thank the other members of the Lincoln TCAS surveillance team, Loren Wood and Chuck Rose, who contributed regularly to this work by discussion of analyses and results and review of documentation. In addition, substantial expertise and help with the receiver installation and siting were provided by Dan Oberlander and Brian Adams. We would also like to thank Adam Heskitt, a summer intern, who processed the 1090 MHz Extended Squitter data.

This page intentionally left blank.

## EXECUTIVE SUMMARY

This is the second report of MIT Lincoln Laboratory 1030/1090 MHz monitoring, covering the period March through June 2010. This monitoring is performed as a part of MIT Lincoln Laboratory Traffic Alert and Collision Avoidance System (TCAS) work for the Federal Aviation Administration (FAA). Lincoln Laboratory is monitoring the two frequency bands used by TCAS, 1030 and 1090 MHz, to determine the rates of signal transmissions and to help understand whether the observed rates are having any adverse effects on TCAS performance.

TCAS is an airborne collision avoidance system that operates independently of the ground Air Traffic Control System and provides a safety backup to the separation assurance function supported by radar. TCAS works by actively interrogating nearby transponder equipped aircraft and tracking the received replies. For each tracked aircraft, TCAS determines if the aircraft is projected to become a collision threat, and if so, issues a vertical maneuver (Resolution Advisory or RA) to the pilot. TCAS uses the same 1030/1090 MHz interrogation/reply frequencies as the ATC ground radars. TCAS contains algorithms to limit its use of these frequencies so as not to interfere with the ground's ability to perform aircraft surveillance.

There has been much recent interest in TCAS's use of the 1030/1090 MHz frequencies for two main reasons. First, Automatic Dependent Surveillance-Broadcast (ADS-B) is being implemented throughout the NAS, and the most common implementation of ADS-B uses 1090 MHz transmissions. Thus, it is useful to measure TCAS's contribution to the 1090 MHz frequency and to see how this contribution varies over time and by location so as to understand the environment in which ADS-B will operate. Second, there has until now been no effective way to understand details of TCAS operation in flight. This can be accomplished by monitoring the second-by-second TCAS transmissions on 1030 and 1090 MHz.

The 1030/1090 MHz monitoring can be divided into three main areas:

- (1) 1030 and 1090 MHz TCAS surveillance interrogations and replies,
- (2) 1030 MHz TCAS air-to-air coordination interrogations and broadcast interrogations, and
- (3) 1090 MHz Extended Squitter transmissions, i.e., the Mode S implementation of Automatic Dependent Surveillance-Broadcast (ADS-B).

Extended Squitter data is examined solely to evaluate the availability and usefulness of ADS-B information for use in collision avoidance systems. Other existing ADS-B monitoring programs are focused on a more general assessment of ADS-B performance and do not specifically address questions related to collision avoidance.

This report analyzes a continuous stream of 1030/1090 MHz data recorded over a four-month period. The analysis looks for patterns that can be understood according to variations in aircraft density and perhaps seasonal variations. The analysis also looks for consistency among different kinds of data, considering the possibility of anomalies in TCAS air-to-air coordination or other transmissions. This report provides a summary of the measurements and also answers specific questions raised during the previous 2009 analysis. The report attempts to provide insights into the meaning of the data with respect to TCAS operation. Also during this time period, significant attention was given to validating the performance of the receiver system used to collect the 1030/1090 MHz data.

Immediately prior to this four-month recording period, the 1030/1090 MHz receiver system was moved from its previous position at the Lincoln Laboratory Flight Facility near Hanscom Field to its current position, 1.2 miles to the east at a higher elevation. This hilltop location provides a higher message reception rate and a greater coverage area than the previous location.

In general, 1030/1090 MHz reception rates were relatively stable over the four-month period and also consistent with the rates shown in the first report [1]. One notable exception occurred during the time of the Icelandic volcano eruption, when flights to and from Europe were curtailed and the decrease in Extended Squitter equipage was immediately noticeable. Similar to the first report, TCAS-generated 1030 MHz and 1090 MHz signals accounted for a majority of the overall 1030 MHz and 1090 MHz signals received. However, in absolute terms, the TCAS contribution to the total 1030/1090 spectrum was quite small. TCAS Mode S 1030 MHz transmissions accounted for 2.4 percent of the total 1030 MHz Mode S time line, and TCAS Mode S 1090 MHz transmissions accounted for 1.8 percent of the total 1090 MHz Mode S time line. Approximately 75 percent of the Mode S equipped aircraft observed were TCAS equipped; and excluding the time around the volcanic eruption, approximately 28 percent of Mode S equipped aircraft were Extended Squitter equipped.

New in this report is a detailed examination of the air-to-air TCAS surveillance messages exchanged between aircraft. This examination allowed us to view TCAS re-interrogations in high density areas and to pinpoint specific aircraft whose surveillance behavior appeared abnormal. Further analysis is planned to determine the frequency with which these aircraft exhibit unusual behavior, whether they appear to have any characteristics in common (e.g., same TCAS or transponder manufacturer), and possible causes of the behavior.

Also new in this report is an automated and in-depth examination of messages transmitted during the TCAS-TCAS air-to-air coordination process. As in the first reporting period, no problems were noted in the coordination of maneuvers between aircraft, but a number of anomalies were seen in messages used to report Resolution Advisory (RA) information (e.g., RA Reports to Mode S ground sensors, RA Broadcast Interrogations, and coordination replies). In addition, two particular groups of aircraft (one U.S. military, one non-U.S. civil) transmitted coordination interrogations that appeared to be unrelated to an RA event, but rather related to interference with surveillance equipment onboard the aircraft. While no adverse affects were observed in actual air-to-air coordination, we believe the potential for adverse affects and/or safety issues exists. Lincoln Laboratory will follow up directly with military representatives, and FAA Certification will explore follow-up with the non-U.S. aircraft representatives.

This report looks briefly at consistency among different types of Extended Squitter messages from a selected aircraft, e.g., whether the velocity computed from sequential Airborne Position Messages is consistent with received Airborne Velocity Messages. Because more than 98% percent of the Extended Squitter-capable aircraft in our airspace contain transponders built to the earliest ADS-B Minimum Operational Performance Standards, most of the Extended Squitter-capable aircraft observed have limited ability to indicate the quality of data being reported. This limits the usefulness of consistency/quality checking at this time. In the near-term, resources are probably better spent investigating the quality of ADS-B data required to provide benefit for collision avoidance algorithms. As more transponders are upgraded to later standards documents, more rigorous and extensive consistency/quality checking should be performed.

The data collected during this four-month period will be used to baseline 1030/1090 MHz activity in the New England area. Future plans call for limited periods of 1030/1090 MHz data recording at various TCAS RA Monitoring System (TRAMS) sites throughout the NAS. The extensive 1030/1090 MHz analysis tools developed to date will allow large amounts of collected data to be examined quickly to determine overall statistics and to locate time periods of particular interest for further study. In addition, 1030/1090 MHz recording at other TRAMS sites can supplement the recorded Mode S radar surveillance data being used in the Lincoln Laboratory TCAS surveillance simulation. The first TRAMS site selected for 1030/1090 MHz monitoring is expected to be New York City's JFK International Airport.



# TABLE OF CONTENTS

Acknowledgments	iii
Executive Summary	v
List of Illustrations	ix
List of Tables	xi
1. INTRODUCTION	1
2. RF SENSOR ENVIRONMENT	3
2.1 Thales Receiver	3
2.2 Receiver Relocation	4
2.3 Validation of Receiver Performance	7
2.3.1 Effects From Mode S Radar	7
2.3.2 Received Power Levels, Measured and Calculated	10
2.4 Measured Transmission Rates	12
2.5 Side-by-Side Testing at Philadelphia	14
2.6 Antenna	15
3. 1030 MHz ANALYSIS	17
3.1 TCAS Air-to-Air Coordination	17
3.1.1 Overview of Coordination Process	17
3.1.2 Automated Analysis	18
3.1.3 Individual Coordination Message Syntax Anomalies	19
3.1.4 In-Depth Evaluation of Coordination Process	21
3.2 TCAS Broadcast Interrogations	28
3.2.1 Results	28
3.3 Future Work	28
4. 1030/1090 MHz TCAS SURVEILLANCE ANALYSIS	31
4.1 Overview	31
4.2 Results	31
4.2.1 Basic Statistics	31
4.3 Future Work	41
5. 1090 MHz EXTENDED SQUITTER ANALYSIS	43
5.1 Overview	43
5.2 Results	44
5.2.1 Extended Squitter Availability	44
5.2.2 Airborne Position Messages	50
5.2.3 Surface Position Messages	52
5.2.4 Aircraft Identification and Category Messages	53
5.2.5 Airborne Velocity Messages	55
5.2.6 Aircraft Operational Status Messages	59
5.2.7 Extended Squitter Aircraft Status Messages	60
5.3 Future Work	60

## TABLE OF CONTENTS (CONTINUED)

6.	SUMMARY	61
	Glossary	63
	References	65
	Appendix A. Additional Analyses to Characterize the 1030/1090 MHz Environment	67
	Appendix B. A Checklist for 1030/1090 MHz Analysis at Remote Sites	73

## LIST OF ILLUSTRATIONS

Figure No.		Page
1	Thales AX680 receiver unit front (top) and back (bottom)	3
2	Thales system installation	4
3	Location of Thales 1030/1090 receiver and Lincoln Laboratory–operated FAA- operated Mode S radar	5
4	Altitude floor of receiver coverage	5
5	Tower with antennas	6
6	Panoramic photo showing 360-degree views from the antenna	6
7	Limiter and power divider between antenna and receiver	7
8	Measured reception rates with the Mode S radar on and off	9
9	Airborne Position Squitter receptions from one aircraft	10
10	Reception rate of Airborne Position Squitters	11
11	Measurements compared with calculations (Airborne Position Squitters)	11
12	Reception rate measurements used to infer transmission rates	13
13	PRM site of Philadelphia data collection	14
14	Antenna installation of Philadelphia data collection	15
15	Antenna installation for Logan measurements	16
16	Coordination-related RF messages	17
17	Sample TCAS-TCAS coordinated encounter, altitude vs. time plot	24
18	Sample TCAS-TCAS coordinated encounter, x/y plot	25
19	Message reception rate in time (1030 and 1090 MHz) June 2010, receiver threshold $\sim$ 80 dBm at antenna	32
20	Received message power, 16 June 2010, two-hour period	33
21	Cumulative received power, 16 June 2010, two-hour period	34
22	Message receptions by type, 16 June 2010, two-hour period	35
23	Mode S message reception rate by format, 16 June 2010, two-hour period	36
24	UF0 and DF0 messages per aircraft per second, 11 May 2010 19:00 UTC	37
25	Number of Mode S and TCAS equipped aircraft, 11 May 2010 19:00 UTC	38

## LIST OF ILLUSTRATIONS (CONTINUED)

<b>Figure No.</b>		<b>Page</b>
26	Number of unique Mode S addresses in UF0 interrogations and DF0 replies, 11 May 2010 19:00 UTC	39
27	Range and time for Mode S aircraft from Lincoln Mode S radar, 11 May 2010 19:00 UTC	39
28	UF0 and DF0 rate for one aircraft (expected behavior)	40
29	UF0 and DF0 rate for one aircraft (unexpected behavior)	40
30	Counts of ES-transmitting aircraft	45
31	Counts of ES-transmitting aircraft, April 2010	46
32	ES information for 11–17 April 2010	47
33	ES availability by country (highest counts)	48
34	ES availability by country	49
35	Aircraft transmitting Extended Squitter registers	50
36	ES messages received (previous and current receiver locations)	51
37	ES messages received (11 April and 17 April 2010)	52
38	Sample Surface Position Messages at Hanscom Field	53
39	Aircraft location from ES Airborne Position Messages	57
40	Altitude vs. time from Version 1 ES Airborne Position Messages	57
41	Vertical rate vs. time from Version 1 ES Airborne Velocity Messages	58
42	Altitude vs. time from Version 1 ES Airborne Position Messages	58
43	Vertical rate vs. time from Version 1 ES Airborne Velocity Messages	59

## LIST OF TABLES

<b>Table No.</b>		<b>Page</b>
1	Message Bit Errors	20
2	Sample Automated Output File	23
3	Single Encounter Sample Output	26
4	Mode S Formats	35
5	TCAS Contribution to the 1030/1090 MHz Spectrum	36
6	Basic Six Extended Squitter Messages, or Minimum ADS-B Message Set	43
7	Aircraft Identification Messages	54
8	Sample Invalid Aircraft Identification Strings	54
9	Summary of All Airborne Velocity Messages	55
10	Version 1 Airborne Velocity Messages	56
11	ES Aircraft Operational Status Messages	59

This page intentionally left blank.

## 1. INTRODUCTION

This is the second report of MIT Lincoln Laboratory 1030/1090 MHz monitoring, covering the period March through June 2010. This monitoring is performed as a part of MIT Lincoln Laboratory Traffic Alert and Collision Avoidance System (TCAS) work for the Federal Aviation Administration (FAA). Lincoln Laboratory is monitoring the two frequency bands used by TCAS, 1030 and 1090 MHz, to determine the rates of signal transmissions and to help understand whether the observed rates are having any adverse effects on TCAS performance.

TCAS is an airborne collision avoidance system that operates independently of the ground Air Traffic Control System and provides a safety backup to the separation assurance function supported by radar. TCAS works by actively interrogating nearby transponder equipped aircraft and tracking the received replies. For each tracked aircraft, TCAS determines if the aircraft is projected to become a collision threat, and if so, issues a vertical maneuver (Resolution Advisory or RA) to the pilot. TCAS uses the same 1030/1090 MHz interrogation/reply frequencies as the ATC ground radars. TCAS contains algorithms to limit its use of these frequencies so as not to interfere with the ground's ability to perform aircraft surveillance.

There has been much recent interest in TCAS's use of the 1030/1090 MHz frequencies for two main reasons. First, Automatic Dependent Surveillance-Broadcast (ADS-B) is beginning to be implemented throughout the NAS, and the most common implementation of ADS-B uses 1090 MHz transmissions. Thus, it is useful to measure TCAS's contribution to the 1090 MHz frequency and to see how this contribution varies over time and by location so as to understand the environment in which ADS-B will operate. Second, there has until now been no effective way to understand details of TCAS operation in flight. This can be accomplished by monitoring the second-by-second TCAS transmissions on 1030 and 1090 MHz.

The 1030/1090 MHz monitoring can be divided into three main areas:

- (1) 1030 and 1090 MHz TCAS surveillance interrogations and replies,
- (2) 1030 MHz TCAS air-to-air coordination interrogations and broadcast interrogations, and
- (3) 1090 MHz Extended Squitter transmissions, i.e., the Mode S implementation of Automatic Dependent Surveillance-Broadcast (ADS-B).

Extended Squitter data is examined solely to evaluate the availability and usefulness of ADS-B information for use in collision avoidance systems. Other existing ADS-B monitoring programs are focused on a more general assessment of ADS-B performance and do not specifically address questions related to collision avoidance.

This report analyzes a continuous stream of 1030/1090 MHz data recorded over a four-month period. The analysis looks for patterns that can be understood according to variations in aircraft density and perhaps seasonal variations. The analysis also looks for consistency among different kinds of data, considering the possibility of anomalies in TCAS air-to-air coordination or other transmissions. This report provides a summary of the measurements and also answers specific questions raised during the previous 2009 analysis. The report attempts to provide insights into the meaning of the data with respect to TCAS operation. Also during this time period, significant attention was given to validating the performance of the receiver system used to collect the 1030/1090 MHz data.

The 1030 MHz monitoring allows, for the first time in U.S. airspace, regular widespread recording and examination of TCAS interrogations relating to the threat logic (e.g., TCAS Resolution Messages used in

air-to-air coordination) and other TCAS 1030 MHz messages (e.g., TCAS Broadcast Interrogation Messages used in Interference Limiting and RA Broadcast Interrogation Messages, transmitted by Version 7 TCAS units while an RA is active). German monitoring in recent years [2] had noted problems in these interrogations. The Lincoln Laboratory monitoring allows us to learn the extent of these problems in the U.S., and if necessary, identify steps that might be taken to resolve them.

The 1030/1090 MHz surveillance monitoring examines mainly TCAS air-to-air surveillance interrogations/replies and ground-to-air and air-to-ground surveillance interrogations/replies. This monitoring allows for compilation of accurate statistics on the contribution of TCAS to the radio frequency (RF) environment. In addition, study of TCAS surveillance interrogations and replies can lead to a better understanding of manufacturers' TCAS surveillance implementations and their adherence to the performance standards.

The 1090 MHz monitoring allows examination of Mode S Extended Squitters (ES), which are not recorded by Mode S ground sensors and thus are not available as a part of the TCAS RA Monitoring System (TRAMS) data. Future TCAS or other collision avoidance systems can likely benefit from the use of ADS-B data, if it is shown to meet certain criteria. Lincoln Laboratory compiles statistics on the extent of ES equipage/use, specific messages transmitted, and validity and accuracy of message content. These statistics are compiled solely to evaluate the availability and usefulness of ADS-B information for use in collision avoidance systems. Other existing ADS-B monitoring programs are focused on a more general assessment of ADS-B performance and do not specifically address questions related to collision avoidance.

This second 1030/1090 MHz monitoring report covers the period March through June 2010. Following Section 1, this report is divided into five main sections. Section 2 discusses the receiver and the RF environment in which it is located. Sections 3, 4, and 5 discuss the three monitoring areas, each with subsections on overview, results, and future work. Section 6 gives a summary.

Significant new material in this report includes the following:

- Section 2 describes validation of the receiver performance.
- Section 3 describes and gives results of an automated and in-depth examination of messages transmitted during the TCAS-TCAS air-to-air coordination process.
- Section 4 contains an examination of TCAS surveillance interrogations (UF0) and replies (DF0).

Appendix A describes additional and expanded analyses and results, including analyses that make use of combined TRAMS data and 1030/1090 MHz receiver data. Appendix B gives a checklist of analyses to be performed at remote sites in order to compare the 1030/1090 MHz environment at those sites with the New England baseline environment described in this report.



## 2. RF SENSOR ENVIRONMENT

### 2.1 Thales Receiver

The receiver used in the Lincoln Laboratory monitoring is a compact rack-mountable Thales 1030/1090 receiver unit designated the AX680. The unit is configured to receive RF signals via an omni-directional antenna and cable through the connector on the front panel of each of the receiver cards and provide decoded data output via the Ethernet port on the rear panel. Two receivers are included, one configured for 1030 MHz and one configured for 1090 MHz. A Precision Timing Module is included to synchronize time to GPS. Figure 1 shows front and back views.



Figure 1. Thales AX680 receiver unit front (top) and back (bottom)

The receiver is connected to an omni-directional antenna (Figure 2) mounted on top of an existing tower. The receiver and associated data recorder/server, tape archive, and RAID storage device reside in a single rack in a building at the base of the tower. The receiver sends data via a dedicated Ethernet link to the data recorder/server, which is connected to a UPS to prevent data loss during power failure. The server in turn records data to an 8TB RAID storage device. Data is periodically (approximately every six to eight months) archived to tape for long term storage.

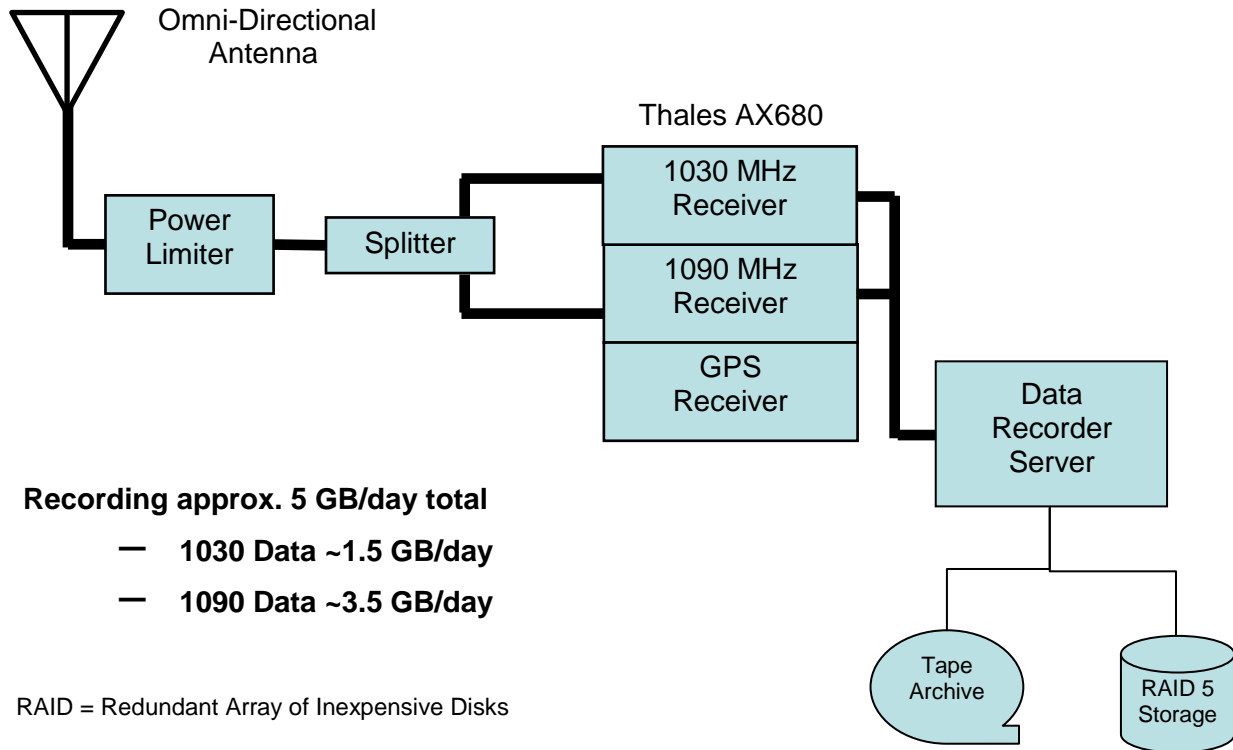

Figure 2. Thales system installation

## 2.2 Receiver Relocation

In early 2010, Lincoln Laboratory relocated the Thales receiver to a tower mounted location, as shown in Figure 3. The installation is on Katahdin Hill in Lexington, Massachusetts, not far from the main Lincoln Laboratory buildings. The receiver is located in a small building at the base of the tower. The hilltop site provides a good view of the New England airspace and results in a higher message reception rate and a greater coverage area than the previous location, as shown quantitatively in Section 5.2.2. The surroundings are mostly tree-covered, which is helpful in minimizing reflections from the ground.

Figure 4 shows the geographical region with superimposed circles to indicate the approximate line-of-sight ranges visible from the Thales receiver. These range limits, marked with aircraft altitudes, are the consequence of earth curvature and terrain/obstructions. The values shown here are approximations based on the furthest received ADS-B positions from aircraft of opportunity at a given altitude.

The new site is near the Lincoln Laboratory–operated FAA Mode S radar. The distance between the radar and the Thales omni-directional antenna is about 200 feet. Consideration was given to possible interference from the radar. As the radar antenna scans, there are times when its high-gain antenna points directly at the Thales omni-directional receiving antenna. The radar is transmitting interrogations at 1030 MHz, and the Thales receiver is receiving at that frequency, so the received power level will be very high at those times. These conditions have been analyzed with supporting measurements and found to not be a problem, as described in Section 2.3.

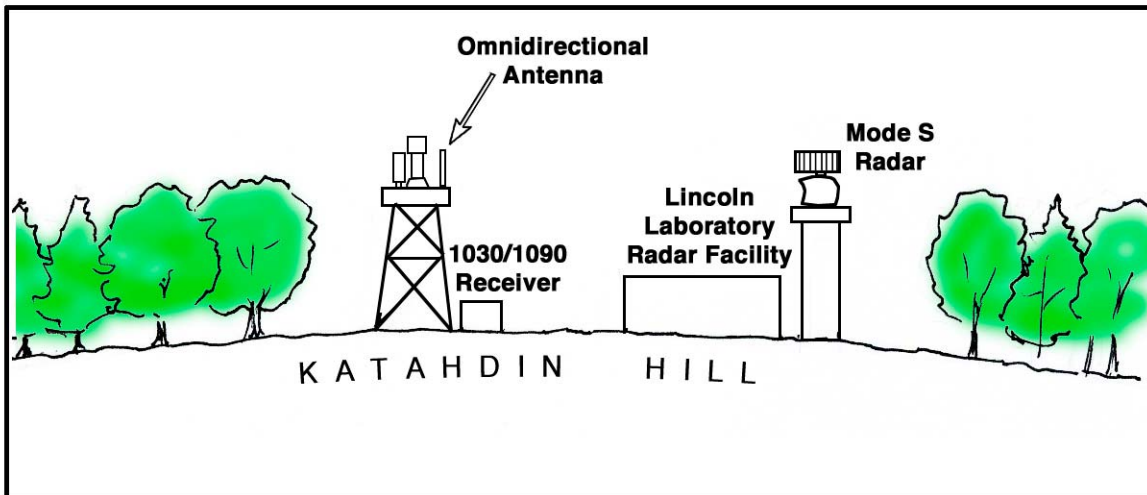

Figure 3. Location of Thales 1030/1090 receiver and Lincoln Laboratory–operated FAA Mode S radar

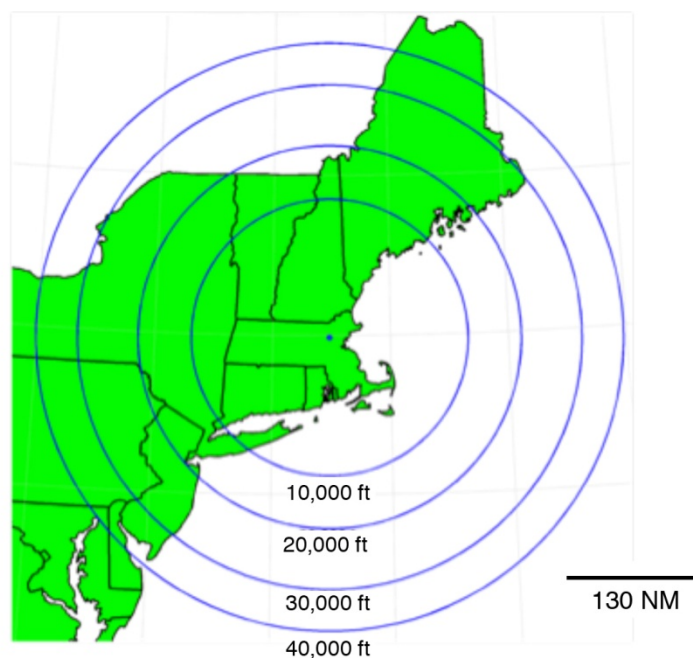

Figure 4. Altitude floor of receiver coverage

The tower is being shared among a number of antennas as shown in Figure 5. The other antennas cause obstructions in some directions. Figure 6 is a panoramic photo of the views in all directions, calibrated by azimuth directions with respect to true north. The view of the New England airspace is unobstructed over more than 50 percent of all azimuth directions.



Figure 5. Tower with antennas

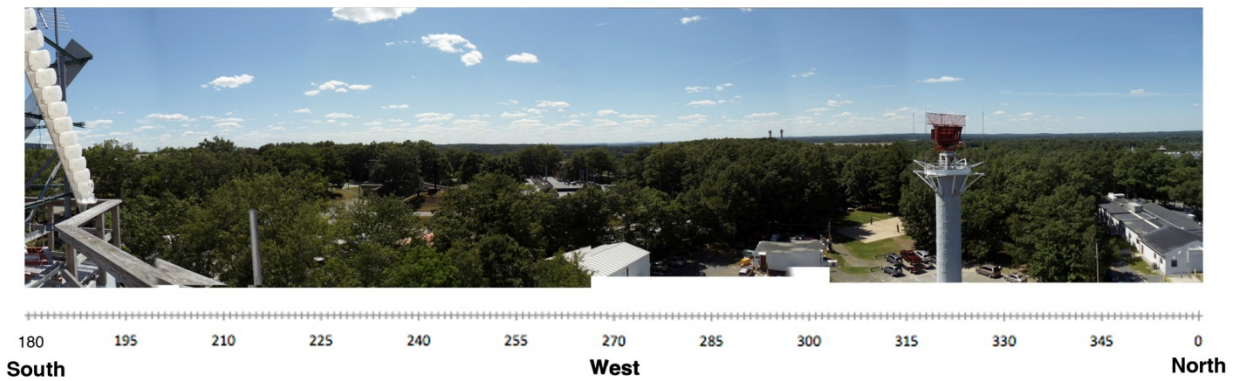
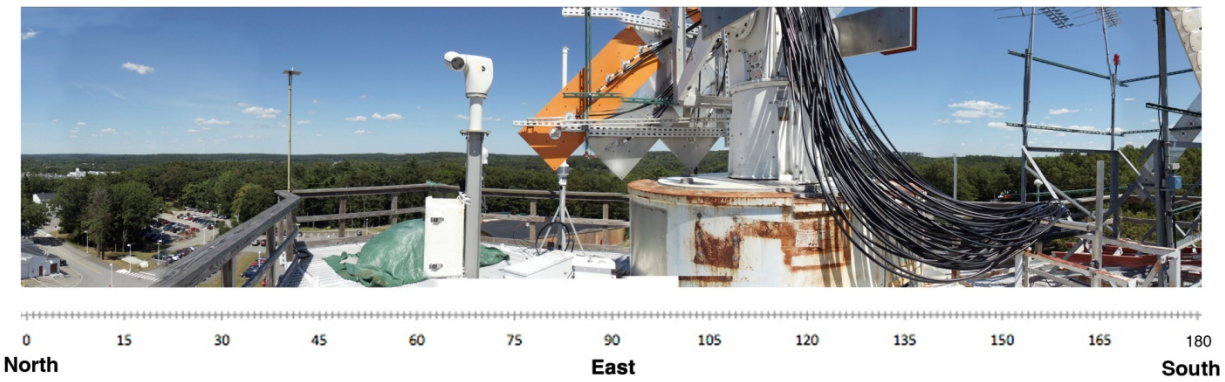

Figure 6. Panoramic photo showing 360-degree views from the antenna

## 2.3 Validation of Receiver Performance

### 2.3.1 Effects from Mode S Radar

Although the Thales omni-directional receiving antenna is mounted on a tower with a good view of the surrounding airspace, it is near the operating Mode S radar, as illustrated in Figure 3. It was therefore necessary to determine whether transmissions from the radar would degrade the omni-directional receptions.

The initial consideration was whether the Thales receiver would be damaged by receptions from the radar. To prevent any receiver damage, a limiter was installed at a point before the receiver, as illustrated in Figure 7. The limiter attenuates all receptions by a small amount (0.2 dB), which is not a problem because the amount of attenuation is used as an adjustment to the measured power levels. The final power levels are referred to the levels before the limiter.

The radar transmissions are interrogations in the 1030 MHz band and as such are accepted by the Thales receiver. No steps are taken to eliminate these, because they are considered to be signals of interest, to be included in the total reception rates being measured.

The interrogations from the radar can also be considered to be interference affecting reception of other signals. Because of the proximity of the radar to the omni-directional receiver, the power levels can be considerable even in the side-lobes and back-lobes, when the main-beam is pointing away from the omni-directional antenna. However, over a full radar scan, the average time occupied by radar interrogations is less than one percent. Therefore even the total of all radar interrogations does not degrade the reception rate from all other sources by more than one percent.

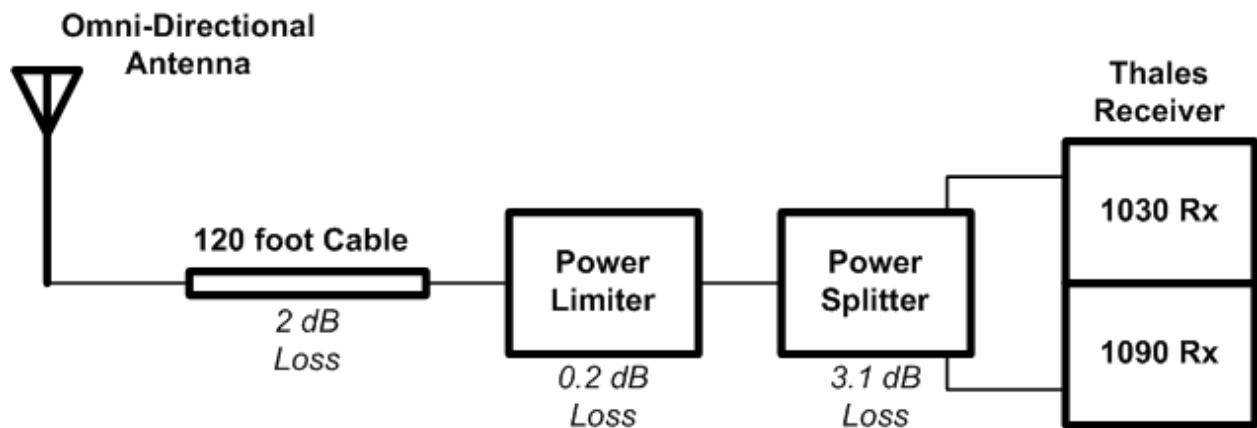

Figure 7. Limiter and power divider between antenna and receiver

Direct measurements were made to validate the conclusion that radar proximity does not significantly degrade omni-directional reception. The first step was to use a spectrum analyzer and view the received log video waveforms, with the Mode S radar on at times and off at times. In viewing the log video, attention was focused on the time periods between radar interrogations. It was concluded that the relatively long time periods between interrogations are free of any interference from the radar.

A second test was done by focusing on reception rate under normal conditions — receiving Mode S and ATRBS messages from the local RF environment. The omni-directional reception rate was measured, both with the Mode S radar transmitter turned on and off, and results were compared. Figure 8 shows the

comparison. The top plot shows the measured reception rate of UF11 messages, short 1030 MHz ground sensor surveillance interrogations, during the time of the aforementioned test. The UF11 reception rate dramatically decreases during the period of time the radar was turned off, as expected because the radar is the primary source of this message type. The abrupt change in UF11 reception rate is therefore a perfect indication of time period the radar was off. This time period has been signified with dashed red lines.

During this test, we observed the simultaneous effects on UF16 and DF17 reception rates (middle and lower plot in Figure 8). UF16 messages are long special surveillance interrogations, e.g., coordination and broadcast interrogations transmitted by TCAS. The UF16 reception rate naturally fluctuates with time, and therefore we would expect to see some slow changes in the rate. However, if the radar interfered with 1030 MHz reception, we would expect to see an abrupt change in the UF16 reception rate when the radar was either turned off or turned on. No significant changes in UF16 reception rate were observed at these times, so we can conclude that the radar has no effect on the 1030 MHz reception.

A similar analysis was performed on DF17 reception rate to understand the effects of the radar on 1090 MHz reception. DF17 messages are Mode S Extended Squitters, the Mode S implementation of ADS-B. The measured DF17 reception rate is shown in the bottom plot of Figure 8. Similar to the UF16 reception rate, the DF17 reception rate naturally fluctuates with time; therefore slow changes in the DF17 reception rate are expected. However, an abrupt change in DF17 reception rate when the radar is turned on or turned off would imply that the radar interferes with 1090 MHz reception. An abrupt change was not observed, so we can conclude that the radar has no effect on the 1090 MHz reception.

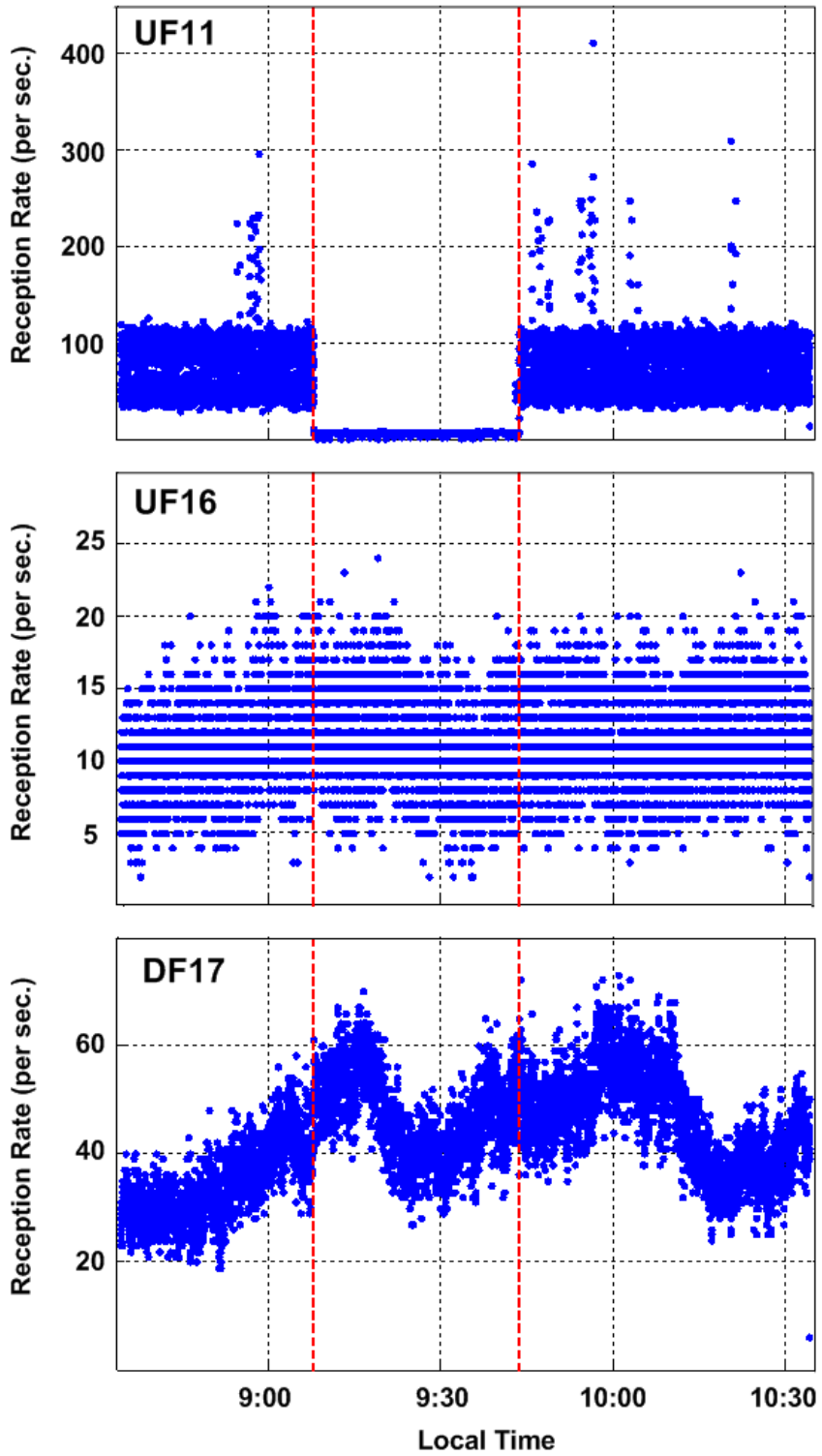

Figure 8. Measured reception rates with the Mode S radar on and off

### 2.3.2 Received Power Levels, Measured and Calculated

Another validity check was made by focusing on received power levels, comparing the measured values with calculated values based on aircraft range. This comparison was made for ADS-B Position Squitters. The reception of Airborne Position Squitters provides a convenient way to judge the validity of the reception process. Each Airborne Position Squitter includes the latitude-longitude of the transmitting aircraft, which is helpful in determining the expected received power. Also, the transmission rate is known to be two per second, so the reception rates can be judged accordingly. Figure 9 shows the Airborne Position Squitter receptions from a single aircraft. The expected two per second timing pattern is clearly shown. Furthermore these measurements reveal an alternating pattern between two power levels about 8 dB apart. Presumably this difference is caused by the top and bottom antennas on the transmitting aircraft; it appears that the transmissions were alternating regularly between the top antenna and the bottom antenna, which is correct.

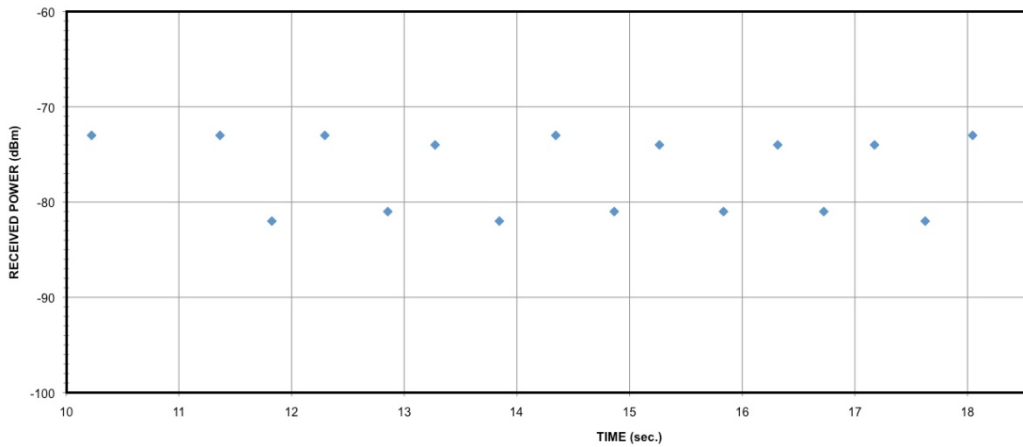

Figure 9. Airborne Position Squitter receptions from one aircraft

Figure 10 shows Airborne Position Squitter reception-rate values for a number of aircraft, given as a function of the received power level. The individual points are measured values, to which the smooth curve was fitted to suggest an underlying trend. These results are consistent with the nominal transmission rate of two per second, and they also show a reduction of reception rate for weak signals. That reduction is to be expected because of the effects of multiple receptions from other aircraft that tend to compete with a weak signal.

Figure 11 provides a comparison between measured power levels and rates and calculated values. This is a cumulative format in which each point is the rate of all receptions having power levels at or above the abscissa value. This data applies to Airborne Position Squitters received in a 70 second period on 4 May 2010 at 15:04 EST. The received squitter data was used to determine the location of each aircraft, from which we were able to determine the range between the aircraft and the omni-directional receiver. Based on the free space path loss associated with this derived range and a simple model in which every aircraft transmitter power is 250 watts and aircraft antenna gain is 0 dB, we were able to calculate the expected received power level of each Airborne Position Squitter. The calculation also used the measured elevation pattern of the receiving omni-directional antenna (antenna gain of 7 dB at zero elevation angle increasing to 9.5 dB at 5 degrees).



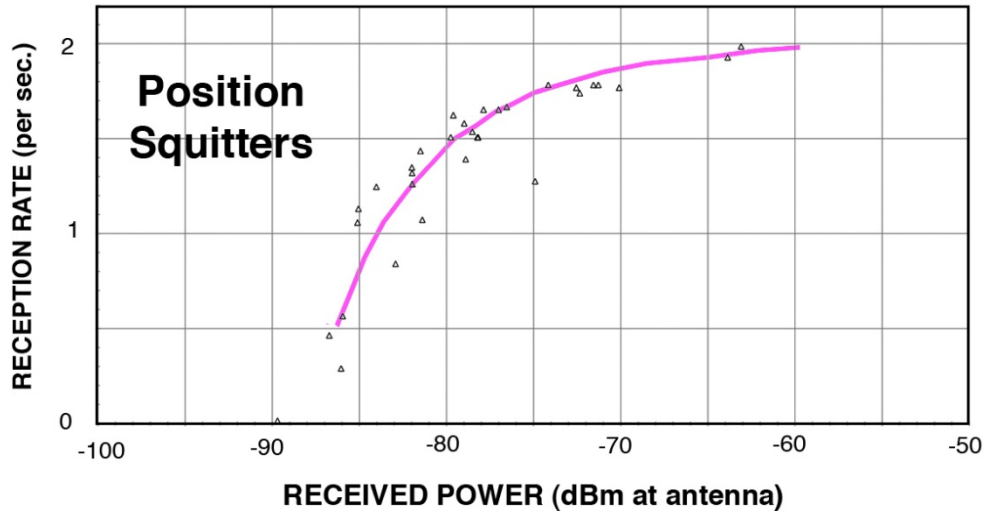

Figure 10. Reception rate of Airborne Position Squitters

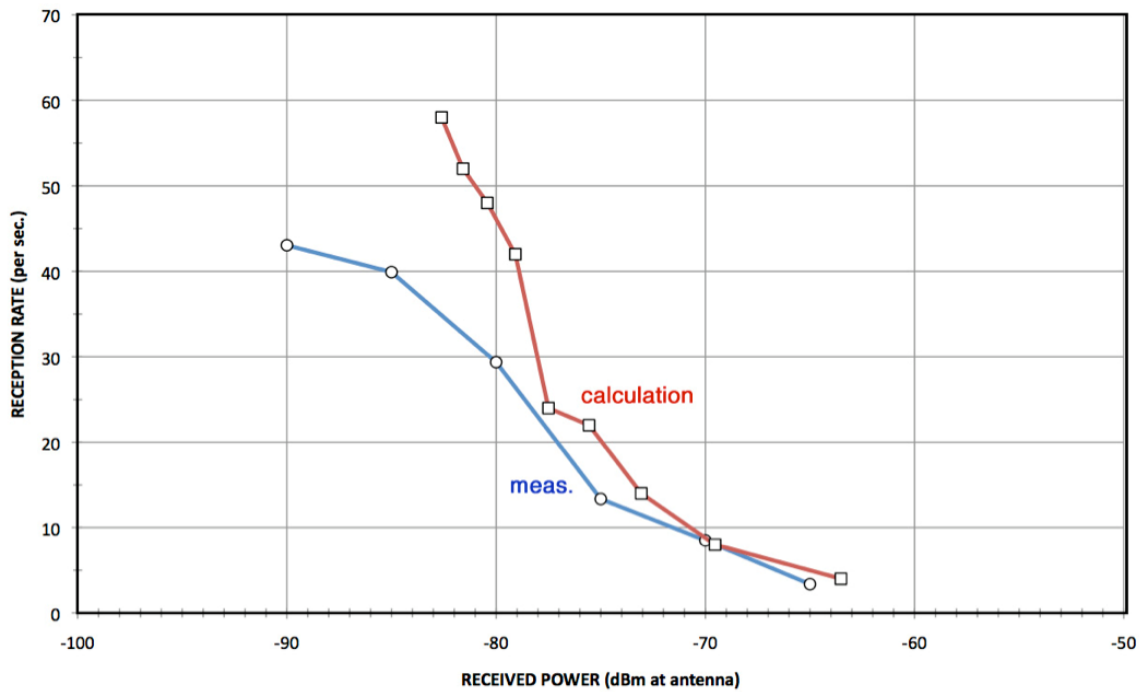

Figure 11. Measurements compared with calculations (Airborne Position Squitters)

Comparing the measurement with the calculations in Figure 11, there is good agreement on the right side of the plot, and less so on the left. The difference on the left (weak receptions) can be attributed to the decrease in reception probability seen in the previous figure. That effect was not included in the calculation. For higher powers, the two curves agree moderately well. There appears to be a consistent difference of about 2 dB, in the direction that the measurements are weaker than the calculated values.

That difference could be caused by a difference in the aircraft transmitter power levels relative to the simple 250 watt model, or a similar difference in the aircraft antenna gain values. The measurements used in this comparison (Figure 9) were obtained from all azimuths, including the directions affected by obstructions on the tower, so those effects could also affect the comparison.

The main conclusion from the validation steps summarized in Figures 9, 10, and 11 is that the new antenna installation on Katahdin Hill is considered to be capable of making accurate measurements of the 1030/1090 environment in the New England airspace.

## 2.4 Measured Transmission Rates

Figure 10 above showed the nature of the drop in reception probability for weak receptions, and it also provided a measurement of the transmission rate for Airborne Position Squitters. That transmission rate is supposed to be two per second, so it's not surprising that the measurement agreed with that, but the same technique makes it possible to measure the transmission rate of other message formats, for which the transmission rates are not fixed constants.

Figure 12 presents reception data for DF0s (replies to TCAS), DF4s (replies to radars), and DF11s (short squitters and All-Call replies to radars). The data in Figure 10 is repeated here for comparison.

Looking at these reception rate plots, it is evident that they are not as tightly clustered as in Figure 10. The increase in scatter can be attributed to the fact that different aircraft transmit at different rates. In the upper plot, for example, DF0 replies to TCAS depend on where the replying aircraft is located. Also some of these scattergrams have noticeable departures from the smooth trend marked in color, which could be understood by the possibility that nearby aircraft (stronger powers) may experience higher transmission rates.

In spite of the large scatter, it is possible to make an estimate of each of the average transmission rates for these message types:

Average transmission rate from one aircraft (measured) ~  
2.4 per second for DF0 (replies to TCAS)  
0.75 per second for DF4 (replies to SSRs)  
5.2 per second for DF11 (short squitters and All-Call replies to SSRs)

The lowest rate shown corresponds to DF4s, replies to Secondary Surveillance Radars (SSRs). The measured rate, 0.75/sec., seems consistent with the fact that any one Mode S SSR can perform surveillance with a single interrogation and reply. So the average rate for replies to one SSR would be approximately 1 reply per scan, which is about 0.2 per second. Several SSRs will raise the total to approximately the value measured here.

The highest rate shown corresponds to DF11s. These consist of both short squitters and All-Call replies. These two types can be measured separately by reading the II field. The breakdown into the two types is shown in Section 4.2.1.3, which concludes that about 26% of these are short squitters and 74% are All-Call replies. Therefore, the per aircraft transmission rates are:

DF11 transmission rate = 1.4 per second for short squitters  
3.8 per second for All-Call replies

The top plot in Figure 12 shows the TCAS surveillance reply rate, transmitted per aircraft per second to all TCAS interrogators. The value measured here, 2.4 per second, is of interest in understanding the behavior of TCAS today. Section 4.2.1.4 describes TCAS surveillance performance in detail.

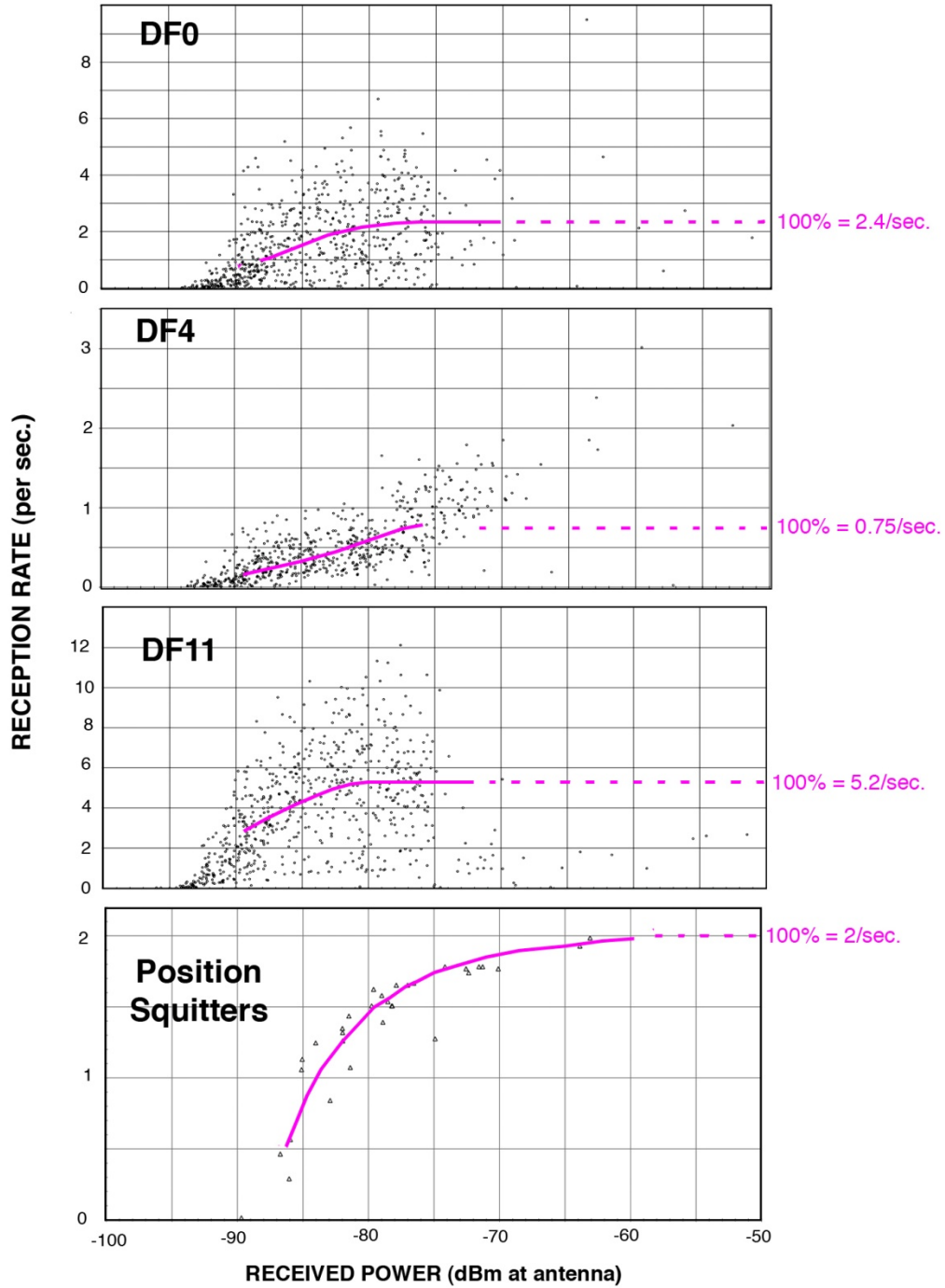

Figure 12. Reception rate measurements used to infer transmission rates

## 2.5 Side-by-Side Testing at Philadelphia

The FAA William J Hughes Technical Center (WJHTC) has long operated a 1030/1090 MHz monitoring system, referred to as the Data and Transponder Analysis System (DATAS), recently upgraded to become DATAS II. Lincoln Laboratory and WJHTC recently embarked on a side by side 1030/1090 MHz measurement program for the purpose of comparing and validating the two measurement systems.

On September 1, 2010, Lincoln Laboratory and WJHTC simultaneously collected 1030/1090 MHz data at Philadelphia International Airport. This data collection was performed at the Precision Runway Monitor (PRM) site which is located just south of the airport's parallel runways. A photograph of the PRM site is shown in Figure 13. This site was selected by WJHTC due to previous experience with taking measurements at this location.



*Figure 13. PRM site of Philadelphia data collection*

The antennas used by the Lincoln Laboratory 1030/1090 Monitoring System and DATAS II were installed in very close proximity. Figure 14 depicts the installation of the antennas atop the WJHTC truck. The Lincoln Laboratory 1030/1090 MHz Monitoring System used one antenna which was mounted at the right rear of the WJHTC truck and is labeled “LL” in the figure. DATAS II used two separate antennas: one antenna for 1030 reception and the other for 1090 reception. These two antennas were mounted on either end of the WJHTC truck and have been labeled accordingly in the figure.

The data collected during the Philadelphia test is currently being processed and analyzed. Lincoln Laboratory is coordinating with WJHTC to ensure that a comprehensive comparison of the two systems is performed. A more detailed analysis of the measurements taken at Philadelphia will be the subject of a separate report.

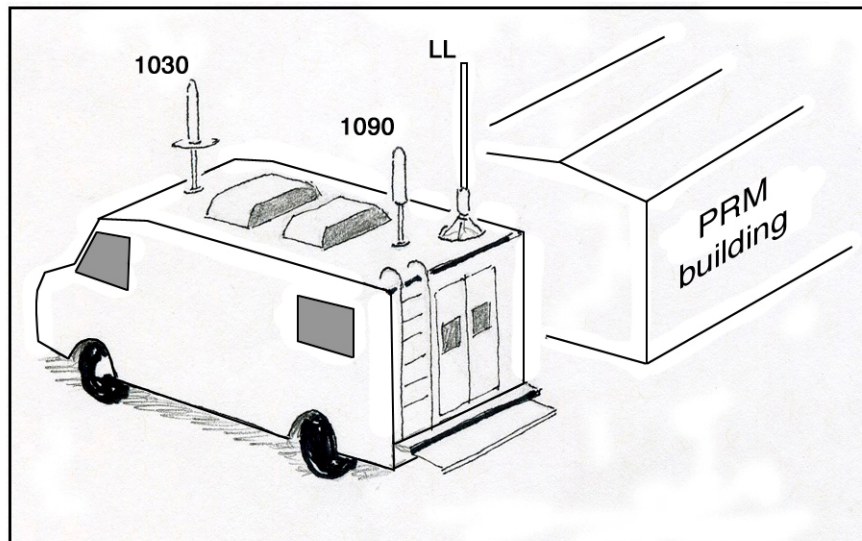

Figure 14. Antenna installation of Philadelphia data collection

## 2.6 Antenna Siting

While the current site of the Thales omni-directional receiving antenna is at Lincoln Laboratory in Lexington, Massachusetts, consideration is being given to other possible sites. It would be interesting, for example, to acquire data in a very busy metropolitan area such as JFK airport, near New York City. In the current Lexington site, the nearby radar operates only as a Secondary Surveillance Radar (SSR). The radar installation can also operate a Primary Surveillance Radar (PSR), but currently the PSR is not being used. As described in section 2.3.1, the omni-directional reception rates are being accurately measured in the presence of the SSR, but for other sites it is necessary to consider possible interference from a nearby PSR.

A test was undertaken to determine whether there would be any adverse interference effects from a nearby PSR. The test was performed at Logan International Airport in Boston. In coordination with the FAA personnel at Logan, a test was conducted during a regular nighttime maintenance period. The test was carried out on 18 July 2010, at a time when the FAA had planned to shut down both the PSR and the SSR for a short period. As shown in Figure 15, Lincoln Laboratory made a temporary installation of the omni-directional antenna and Thales receiver very near the FAA radar. The omni-directional receiving antenna was suspended from the side of the radar tower as shown in the photograph.

By recording omni-directional reception rates steadily during an extended period beginning before the shutdown and continuing through and after the shutdown, it was possible to make a direct comparison looking for any degradation from the radar. The results did not show any changes at the times of beginning the radar shutdown and restarting the radar. It was concluded that omni-directional measurements of receptions in the 1030 and 1090 MHz bands using the equipment currently installed in Lexington can be made at other sites even if the antenna is located near an FAA radar.



*Figure 15. Antenna installation for Logan measurements*

### 3. 1030 MHz ANALYSIS

#### 3.1 TCAS Air-to-Air Coordination

##### 3.1.1 Overview of Coordination Process

Figure 16 shows coordination between two TCAS equipped aircraft, highlighting the various coordination-related RF messages:

1. TCAS coordination interrogation (UF16-30)<sup>1</sup>
2. TCAS coordination reply (DF16-30)
3. RA broadcast interrogation (UF16-31)
4. RA Report (DF20 or DF21)

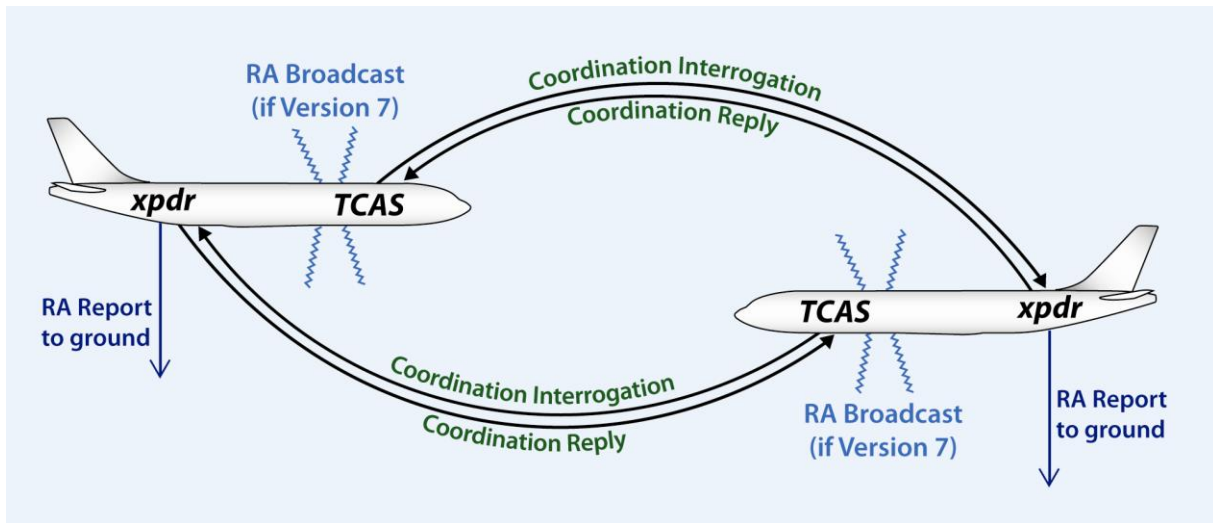

Figure 16. Coordination-related RF messages

In a TCAS-TCAS encounter, during the period that TCAS is issuing an RA, TCAS transmits a coordination interrogation once per second to the intruder TCAS. As shown in Figure 16, the coordination interrogation is transmitted by the TCAS unit and is received by the transponder on the intruder aircraft. The transponder then passes the message to its associated TCAS unit for processing. The interrogation contains a Vertical Resolution Advisory Complement (VRC), indicating “don’t climb” or “don’t descend.” This field is the primary mechanism to indicate sense selection and is used by the intruder to select a complementary sense. The intruder transponder replies with a coordination reply, which is simply a technical acknowledgement indicating that the intruder aircraft’s transponder has received the coordination interrogation. (If the originating TCAS does not get a reply, it will re-try 6–12 times over a 100 ms period.)

<sup>1</sup> The notation ‘UF16-30’ means Uplink Format 16 (i.e., Mode S long air-to-air special surveillance interrogation) with message type 30<sub>hex</sub> (identifying a coordination message).

Also, during the time that TCAS is issuing an RA, it sets a bit in all air-to-ground surveillance replies saying that there is TCAS RA information available for read-out. Any Mode S ground sensor that is tracking the TCAS aircraft will then automatically request an RA Report from the Mode S transponder onboard the TCAS aircraft. In addition, Version 7 TCAS units will broadcast RA information every 8 seconds. The RA Broadcast is an uplink transmission but is intended to be received by a low-cost sensor (e.g., modified transponder) on the ground.

For every TCAS-TCAS encounter, Lincoln Laboratory examines each of the above four messages for consistency. If the encounter occurs within the coverage of our Mode S radar, we can also plot the encounter geometry (both horizontal and vertical profiles for the two aircraft) to determine if the RA appears consistent with the geometry. This work is described in Sections 3.1.2 to 3.1.4.

### **3.1.2 Automated Analysis**

The previous monitoring report examined a seven day period of coordination-related messages. Due to the rarity of TCAS-TCAS coordinated encounters, this short period provided only a small sample of encounters and coordination messages for analysis. This monitoring report uses a four month period of 1030/1090 MHz recorded data which provides a much broader examination of the coordination process.

The vast amount of data collected during this four month period required new tools and methods for processing and analysis. Lincoln Laboratory developed a set of tools to automate the TCAS coordination evaluation process. The software is able to quickly perform the analysis that was performed manually in the previous report and introduces a new in-depth coordination process evaluation. The automated program produces a short summary of each coordinated encounter detected, including information on message anomalies, consistency in the coordination process, and consistency in the rate and timing of coordination messages.

The coordination-related RF messages listed in Section 3.1.1 are first extracted from the data recorded by the Thales receiver. Messages are validated prior to analysis by checking for correct address parity (AP), which ensures that the data contained within each message was received as transmitted. This is done by comparing the decoded AP field of each message to Mode S addresses received in DF11 squitters on the same day. All the bits that make up the message are considered to have been received correctly if the address decoded from the AP field matches a received DF11 squitter address. This error detection method is not the 'true' error detection performed by a Mode S ground sensor or an aircraft Mode S transponder since the true process requires knowledge of the expected Mode S address, and this address cannot be known during the 1030/1090 monitoring process. However, the process described above is an accepted technique for error correction performed by monitoring systems. Messages that fail this AP test are excluded from results unless otherwise noted.

Initially, each message received is evaluated on an individual basis for correct syntax and formatting. In this step, the fields of each message are checked for invalid values and formatting. Every message is checked for specific anomalies which will be discussed in Section 3.1.3. Many fields may contain data that could be valid, but these data must be evaluated in the context of a coordinated TCAS-TCAS encounter to determine whether they are accurate.

Section 3.1.4 describes the evaluation of messages generated during coordinated encounters. In order to evaluate the messages as part of the coordination process, each encounter and its corresponding messages are isolated for further analysis. The program individually analyzes each encounter, providing basic information and statistics on the encounter, and flags any errors or unexpected aspects of the encounter. The results of each encounter evaluation are condensed into an output file where all encounters detected over the period of interest can be reviewed.



A specific encounter of interest can then be displayed in full to confirm the conclusions of the automated evaluation and investigate anomalies that were flagged. All coordination messages received are displayed in order received, with all relevant fields interpreted and accompanied by the comments from the automated evaluation.

### ***3.1.3 Individual Coordination Message Syntax Anomalies***

One of the main motivators for 1030 MHz monitoring was a 2006 German monitoring report [2] showing errors in observed TCAS air-to-air coordination messages. Occasional single-message errors are not a serious concern, but sustained errors would prevent coordination of maneuvers and would be considered a safety problem. The most critical of the coordination messages is the 1030 MHz TCAS coordination interrogation. As described below, other coordination-related messages are also examined for completeness.

The German report lists two problems observed with TCAS coordination interrogations and five problems observed with RA Broadcast interrogations:

1. TCAS coordination interrogation with invalid redundancy check. The VRC subfield is protected by an additional parity coding subfield, VSB or Vertical Sense Bits. If the two subfields are not consistent, the receiving TCAS will discard the received message, and coordination will not take place that second.
2. TCAS coordination interrogation with invalid sender address. UF16-30 interrogations contain both a sender and receiver address. If the sender address is incorrect, the receiving aircraft will not use the received information at all or will use it incorrectly.
3. RA Broadcast interrogation with incorrect Mode A code of reporting aircraft (reserved bit set to one instead of zero).
4. RA Broadcast interrogation indicating horizontal RA.
5. RA Broadcast interrogation with all-zero Mode C altitude for reporting aircraft.
6. RA Broadcast interrogation with metric altitude for reporting aircraft.
7. RA Broadcast interrogation using discrete address rather than broadcast (FFFFFF<sub>hex</sub>) address.

The two coordination interrogation problems are of most concern, since they could result in uncoordinated RAs. The five RA Broadcast problems are of lesser concern. RA Broadcasts are not used currently in the U.S.; if they are used at all in other countries, it would be for monitoring purposes.

As shown in Table 2, during the current period of monitoring, only one message with an anomaly mentioned in the German report was detected. The message was a RA Broadcast interrogation with an address other than the broadcast address (FFFFFF<sub>hex</sub>). The Thales receiver decoded the AP field as containing the address FFFFFA<sub>hex</sub>. Because the AP field of RA Broadcast interrogation messages contains the broadcast address rather than a discrete address, the previously mentioned parity check determines only that the address in the AP field does not match the address we expected. It is difficult to determine whether this error is due to a parity error or an error in the transmitted message. This single detected anomaly is not a safety concern as it is not part of a wider pattern.

**Table 1. Message Bit Errors**

<b>Message Type</b>	<b>Anomaly</b>	<b>Lincoln Data</b>	<b>German Data</b>
TCAS coordination interrogation	Invalid redundancy check	no	yes
TCAS coordination interrogation	Invalid sender address	no	yes
RA Broadcast interrogation	Incorrect Mode A code	no	yes
RA Broadcast interrogation	Horizontal RA	no	yes
RA Broadcast interrogation	All-zero Mode C code	no	yes
RA Broadcast interrogation	Metric Mode C code	no	yes
RA Broadcast interrogation	Incorrect broadcast address	yes	yes
TCAS coordination reply	All zeros except for header	yes	no

Two patterns of coordination messages have been observed that appear to be unrelated to actual TCAS-TCAS coordinated encounters. The first pattern includes the anomaly discussed in the previous monitoring report. That is, a unique group of specific aircraft had multiple instances of long duration incorrect TCAS coordination replies (DF16-30). The durations ranged from 20 minutes in the shortest example to 2 hours in the longest example. There was no evidence of another TCAS aircraft in the vicinity (no observed UF16-30 coordination interrogations, RA Broadcast interrogations, or RA Reports). The coordination replies were sent every 30 seconds and always contained zeros in 48 of the 56 message bits; i.e., all subfields except the header subfield were zero.

During the current monitoring period, this anomalous pattern has continued with the same small set of specific aircraft transmitting the anomalous coordination reply messages on an almost daily basis over the entire four month monitoring period. One of these aircraft has been seen transmitting a Mode S address other than its own address, and demonstrates this pattern using both its correct and incorrect address. In some instances, these aircraft have been involved in TCAS-TCAS coordinated encounters; these will be discussed in Section 3.1.3. Lincoln Laboratory and FAA Certification are in the process of informing the relevant operators of the issue.

The second pattern of unusual received coordination messages involves coordination interrogation messages addressed to an address in an unallocated block of Mode S addresses. These messages do not pass parity check; however they were investigated since they appear frequently enough as to make up a large portion of the detected coordination interrogations. Based on the apparent format of the received messages and careful analysis of how a message with such an address could be received on such a regular basis, it was theorized that these messages were not intended to be UF16-30 coordination interrogation messages. The most likely explanation is that these messages originated as UF16-32 TCAS Broadcast interrogation messages<sup>2</sup> whose 39<sup>th</sup> bit was detected as a 0, making it appear as a UF16-30. If this bit flip occurred after the transmitting aircraft had calculated the parity information and before our receiver recorded it as a 0, the message would be recorded as a UF16-30 coordination interrogation.

---

<sup>2</sup> UF16-32 TCAS Broadcast interrogation messages are transmitted every 8 seconds by TCAS aircraft and are used to accumulate the NTA count used for Interference Limiting.

The Thales receiver calculates the parity of all received messages and uses that parity to extract the address from the AP overlay field. While the sender address in each message differed, the address in the AP field always appeared the same once parity overlay was removed. We believe this occurred for the following reasons:

1. Every UF16-32 TCAS broadcast interrogation message is transmitted to the broadcast address; therefore every calculated parity was overlaid onto the same address.
2. The change in the parity code caused by the flipped bit follows the property of superposition through the parity encoding/decoding process.

This theory was verified by taking one of the received messages, calculating the parity of the first 88 bits (with the 39<sup>th</sup> bit set to 1 to replicate a UF16-32) and overlaying the parity onto the broadcast address. The 39<sup>th</sup> bit was then set to 0, the modified parity was calculated, and the AP field parity was removed using the modified parity. The resulting address matched the unallocated address.

TCAS Broadcast interrogation messages (UF16-32) are transmitted with much higher frequency than coordination interrogations (UF16-30), which helps explain why they make up such a large portion of the coordination interrogation messages received. These anomalous messages are not a safety concern and would be ignored by all aircraft since the recipient address would not match their own address. Nonetheless it is suggested that this address permanently remain unallocated.

#### ***3.1.4 In-Depth Evaluation of Coordination Process***

When a TCAS aircraft issues an RA against a TCAS intruder aircraft, own aircraft initiates a sequence of interrogations which elicit replies from the intruder aircraft. If the intruder also issues an RA against the own aircraft, the intruder aircraft initiates a separate sequence of interrogations and replies. Although each interrogation-reply sequence is part of the same coordinated encounter, they can be evaluated separately and thought of as each aircraft's perspective of the encounter. The automated evaluation software treats each aircraft's perspective of the encounter as a distinct encounter event which simplifies the analysis. In a subsequent evaluation step, any sense reversals detected within an encounter are analyzed using information from the perspectives of each aircraft.

Encounters were identified primarily using UF16-30 coordination interrogation messages. These messages include the Mode S address of both the own and intruder aircraft, which are then used to find all other messages related to the encounter. In some cases, UF16-30 coordination interrogations are not received because they are transmitted using a directional beam and the interrogations may have been transmitted in a direction opposite of the 1030/1090 receiver. The DF16-30 replies however are omnidirectional, and when a group of DF16-30 coordination reply messages is received, the encounter is added as a detected encounter. This is done to provide a second perspective on coordinated encounters in which each aircraft declared an RA.

To evaluate whether each encounter correctly implements the MOPS coordination process, messages are ordered by time received. The coordination process evaluation program evaluates the encounter message by message, keeping track of all RA information and process status information inferred from the message fields. Important message fields are examined to determine whether their contents are correctly formatted and consistent with the selected RA. New information and changes inferred from each message are noted and a determination is made whether such information is reasonable given what is known about the coordinated encounter<sup>3</sup>. Of particular concern is whether the vertical sense of all information

---

<sup>3</sup> Depending on the location of both aircraft involved in an encounter, we may not receive every message that was transmitted by both aircraft. Also, additional messages may be detected due to re-interrogations. In most cases these messages have no effect; however, they are flagged as unusual if they could be interpreted as an inconsistency.

exchanged is consistent. Any unusual, suspicious, or incorrect information detected is flagged for further analysis.

For each encounter, consistency in message transmission rates and timing is evaluated. The ratio of expected messages received is calculated for both directional and omni-directional messages<sup>4</sup>. A check is performed on each message type to verify that they were consistently sent at the correct rate. Following the conclusion of an RA, a check is performed to verify that RA downlinks were transmitted to the ground for 18 seconds as required. For version 7 TCAS, it is verified that a RA Broadcast was transmitted immediately following the conclusion of the RA.

The output of the automated analysis includes a summary of each encounter along with information provided by the coordination process and message timing evaluations. Table 2 shows a sample of the automated output file showing basic information, coordination consistency, and timing consistency of five encounter events.

Individual encounters can be reviewed or analyzed further by displaying all messages related to the encounter. In this more detailed format, relevant fields of each message are decoded and listed. For each message, any notes generated by the automated analysis are displayed for verification purposes.

Figure 17 shows a sample coordinated encounter detected during this monitoring period. The figure represents data from the Lincoln Mode S sensor; therefore the aircraft positions shown are spaced approximately 4.6 seconds (one radar scan) apart. The RA information shown comes from the RA Reports that were sent from TCAS1 to the Lincoln Mode S sensor. In the figure, TCAS1 (red) is descending and encounters TCAS2 (blue), which is also descending. Both aircraft issue RAs while making a parallel approach into Boston's Logan International Airport. As indicated in both the vertical and horizontal plots, the TCAS1 RAs reported to the ground are *descend, descend, descend, limit climb, limit climb, limit climb, limit climb*. The last three RAs have the RAT (RA Terminated) bit set, indicating that the RA is no longer being displayed to the pilot. The dotted 'V' in the vertical plot shows the separation (slant range) between the two aircraft, with the point of the V indicating the time of closest approach. The RAs reported to the ground by TCAS2 are complementary to the RAs seen in Figure 17. The pilots of both aircraft appear to follow the RAs.

---

<sup>4</sup> This ratio is used as an indicator of whether the position and orientation of the encounter provided a complete view of the coordination process.

**Table 2. Sample Automated Output File**

<u>DATE</u>	<u>EVENT ID</u>	<u>DURATION SECONDS</u>	<u>VICTIM ID</u>	<u>THREAT ID</u>	<u>UF16-30 # OF MESSAGES</u>	<u>UF16-31 # OF MESSAGES</u>	<u>DF16 # OF MESSAGES</u>	<u>DF20/21 # OF MESSAGES</u>
20100309	e1027	40	xxx1E2	xxx BB6	17	0	24	34
20100309	e1028	28	xxx 109	xxx CA5	7	0	16	8
20100310	e1030	21	xxx 458	xxx 6C7	16	4	28	31
20100310	e1031	21	xxx 6C7	xxx 458	19	4	19	19
20100310	e1034	33	xxx CB8	xxx F1E	7	0	18	21

		<u>PERCENT COMPLETE</u>		<u>#</u>	<u>TIME BETWEEN MESSAGES</u>			<u>DURATION</u>
<u>Event ID</u>	<u>Duration</u>	<u>Directional</u>	<u>Omni</u>	<u>Re-Inter.</u>	<u>UF16-30</u>	<u>DF16</u>	<u>UF16-31</u>	<u>DL Freeze</u>
e1027	40	37.67	38.46	8	1	1		17.49
e1028	28	39.79	55.36	0	0.99	0.99		0
e1030	21	81.01	102.14	10	0.97	0.97	7.8	15.58
e1031	21	87.51	88.47	0	1	1	8	0
e1034	33	31.06	42.47	2	1	1.01		15.87

<u>EVENT ID</u>	<u>COMMENTS</u>
e1027	Ver(7 U) Corr VSL sense = down CVC RA terminated
e1028	Ver(6 U) DN climb 2000 sense = down
e1030	Dual RA: e1031 Ver(7 6) sense = down Corr Pos ≥ VSL CVC RA terminated
e1031	Dual RA: e1030 Ver(M U) sense = up Corr Pos climb ≥ do not descend ≥ VSL CVC RA terminated
e1034	Ver(7 7) sense = down Prev VSL RA terminated

UF16/30 = TCAS coordination interrogation  
 DF16 = TCAS coordination reply  
 UF16/31 = RA Broadcast interrogation  
 DF20/21 = RA Report  
 Ver(x, y) = Equipment version format detected for own aircraft (x) and intruder (y)  
           7 = Version 7, 6 = Version 6.04A, U = unknown  
           M = mixed avionics (TCAS = 7 Transponder = 6)  
 Corr = Corrective  
 Prev = Preventive  
 Pos = Positive  
 VSL = Vertical Speed Limit  
 CVC = Cancel Vertical Resolution Advisory Complement  
 DL Freeze = Period following RA termination where RA data is downlinked to the ground

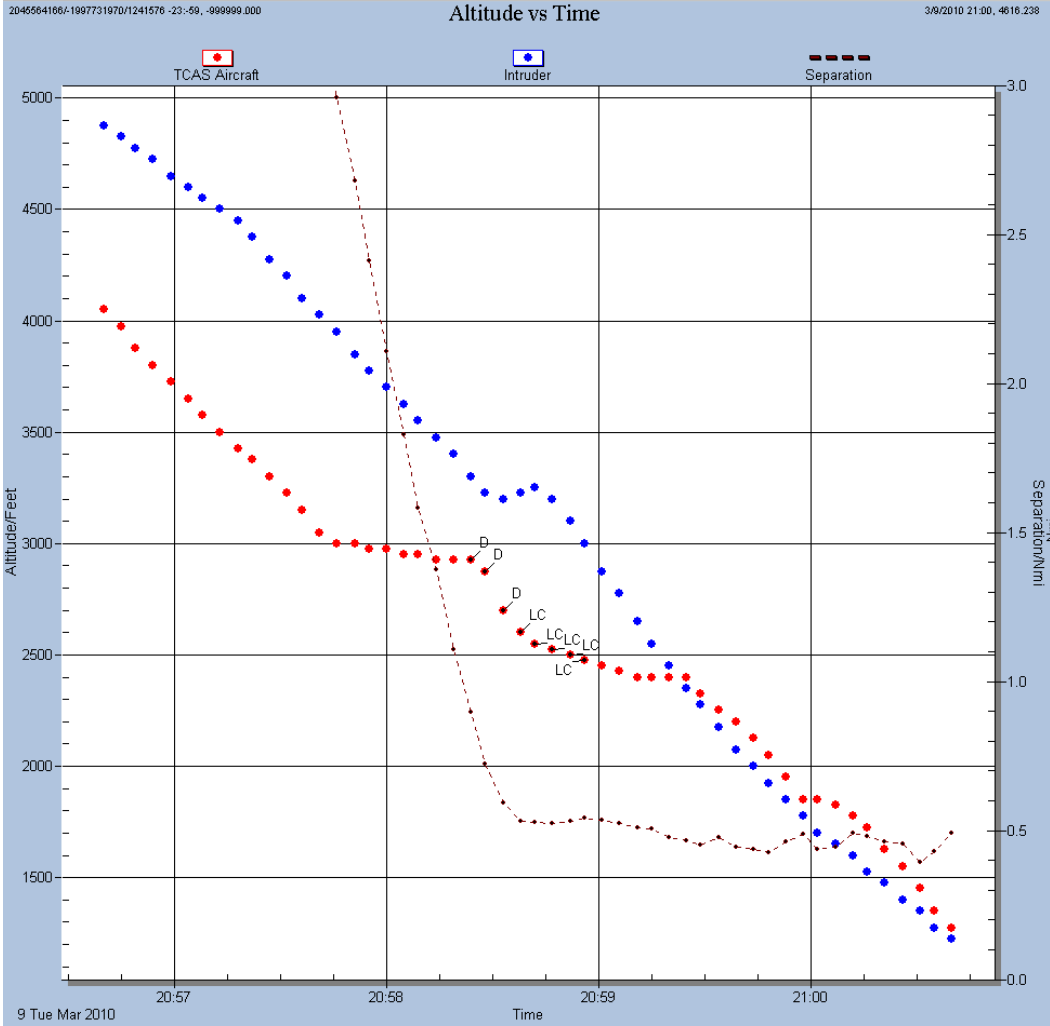

Figure 17. Sample TCAS-TCAS coordinated encounter, altitude vs. time plot

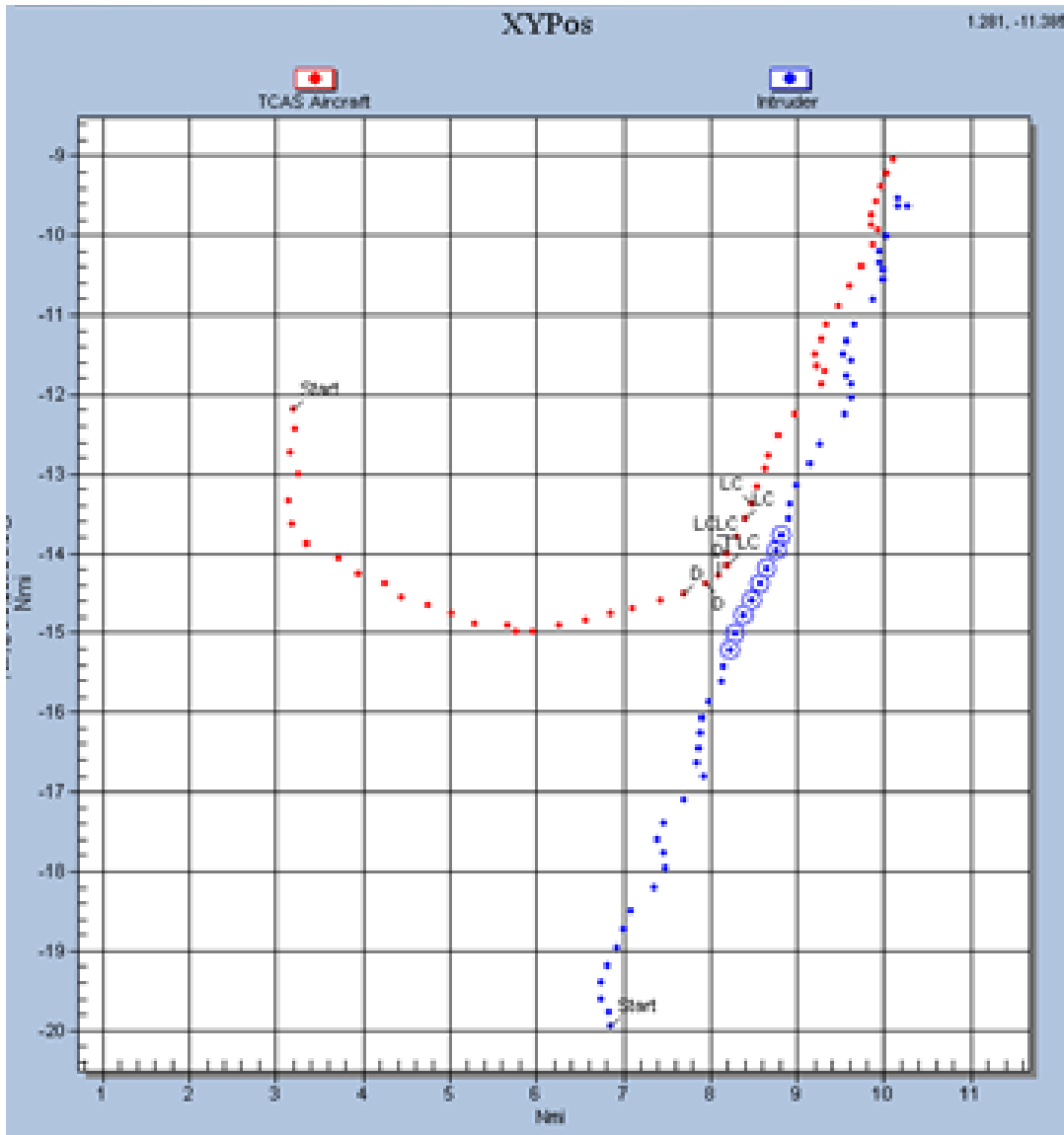

Figure 18. Sample TCAS-TCAS coordinated encounter, x/y plot

Table 3 shows a sample output of all RF messages relating to this RA issued by own aircraft (TCAS1) where both own aircraft and the intruder (TCAS2) have issued RAs.

**Table 3. Single Encounter Sample Output**

Msg #	Time	Msg Type	From->to	RAT	VRC/RAC	CVC	ARA	Comments
1	1:58:22	Cord Interr.	T1->T2		DD			sense = down
2	0	Cord Reply	T2->T1	0	0			
3	0.004	RA Broadcast	T1->	0	0		Corr,Dn,Pos,	Corr Pos
4	0.997	Cord Reply	T2->T1	0	DD			
5	1.013	Cord Reply	T2->T1	0	DD			
6	1.03	Cord Interr	T1->T2		DD			
7	1.03	Cord Reply	T2->T1	0	DD			
8	1.558	RA Report	T1->ground	0	0		Corr,Dn,Pos,	
9	1.906	Cord Interr	T1->T2		DD			
10	1.906	Cord Reply	T2->T1	0	DD		Clm	
11	1.923	Cord Interr	T1->T2		DD			
12	1.923	Cord Reply	T2->T1	0	DD		Clm	
13	2.914	Cord Reply	T2->T1	0	DD		Clm	
14	3.051	RA Report	T1->ground	0	DC		Corr,Dn,Pos,	
15	3.751	RA Report	T1->ground	0	DC		Corr,Dn,Pos,	
16	3.887	Cord Reply	T2->T1	0	DD		Clm	
⋮								
22	6.3	RA Report	T1->ground	0	DC		Corr,Dn,Pos,	
23	6.753	Cord Interr	T1->T2		DD			
24	6.753	Cord Reply	T2->T1	0	DD		Clm	
25	7.667	RA Report	T1->ground	0	DC		Corr,Dn,Pos,	
26	7.758	Cord Reply	T2->T1	0	DD		Clm	
27	7.762	RA Broadcast	T1->	0	DC		Corr,Dn,Pos,	
28	8.363	RA Report	T1->ground	0	DC		Corr,Dn,Pos,	
⋮								
59	19.464	Cord Interr	T1->T2		DD			
60	19.464	Cord Reply	T2->T1	0	DD			
61	20.117	RA Report	T1->ground	0	DC		Corr,Dn,VSL,	
62	20.379	RA Report	T1->ground	0	DC		Corr,Dn,VSL,	
63	20.451	Cord Interr	T1->T2		0	CDD		CVC
64	20.451	Cord Reply	T2->T1	0	DD			
65	20.455	RA Broadcast	T1->	1	DC		Corr,Dn,VSL,	RA terminated
66	21.486	RA Report	T1->ground	1	DC		Corr,Dn,VSL,	
67	22.206	RA Report	T1->ground	1	DC		Corr,Dn,VSL,	
⋮								
78	35.32	RA Report	T1->ground	1	DC		Corr,Dn,VSL,	
79	36.033	RA Report	T1->ground	1	DC		Corr,Dn,VSL,	

T1 = TCAS1, T2 = TCAS2  
 DD = 'don't descend', DC = 'don't climb, CDD = 'cancel don't descend',



Observations from Table 3 include:

1. TCAS1 transmits RA Broadcasts approximately every 8 seconds during the time that the RA is active.
2. TCAS1 transmits RA Reports to the ground. The receiver records RA Reports sent to multiple ground sensors; therefore multiple RA Reports are seen every 4.6 seconds.
3. TCAS1 transmits coordination interrogations (“don’t descend”) to TCAS2 on one second intervals for the duration of the encounter.
4. TCAS2 replies to each coordination interrogation. Replies to interrogations are seen on one second intervals even when the interrogation is not detected by the receiver.
5. TCAS2 indicates in its coordination replies that it has a climb sense RA. Both aircraft have selected complementary RAs.
6. TCAS1 indicates in its RA Reports and RA Broadcasts that it has received a ‘don’t climb’ from TCAS2.
7. Both aircraft indicate that the strength of their RAs have weakened towards the end of the encounter.
8. TCAS1 transmits a “cancel don’t descend” when the RA clears.
9. When TCAS1 cancels the RA, TCAS1 transmits an RA Broadcast with RAT = 1.
10. The RA Reports, with RAT = 1, continue for ~18 seconds after TCAS1 cancels the RA.
11. The RA information is consistent throughout the messages. The RA Broadcasts and RA Reports from TCAS1 indicate a descend sense RA while TCAS2 indicates a climb sense RA. The coordination interrogations from TCAS1 tell TCAS2 to “don’t descend.” TCAS2 reports in its replies that it has received a “don’t descend” from TCAS1. TCAS1 indicates that it has received a “don’t climb” from TCAS2.
12. No errors or inconsistencies were observed in any of the messages or in the coordination process as a whole.

During the four month period covered by this report, 149 TCAS-TCAS coordinated encounters were detected. In thirty-one of these encounters, both aircraft involved issued an RA. In every coordinated encounter detected, aircraft were able to select complementary vertical senses. During the current monitoring period, no multiple threat encounters and no vertical sense reversals were detected in TCAS-TCAS coordinated encounters.

The following observations were made during the monitoring period about issues which are of concern or occurred frequently enough to warrant further investigation.

1. An aircraft appeared to issue an RA against itself. It was detected sending coordination interrogations to itself. The aircraft also replied to these coordination interrogations, and transmitted RA Reports to ground sensors. This TCAS aircraft should have been unable to interrogate and attempt to coordinate with itself; this suggests an issue with its equipment. This encounter will be investigated further.
2. During a coordinated encounter, an aircraft that previously had been correctly generating coordination replies and RA Reports began transmitting messages with all fields set to zero.
3. Fifteen aircraft replied to coordination interrogations with their RAC field set to zero for the entire encounter. It is unknown whether the transponder was failing to insert the RAC into the message or whether the TCAS unit had not received the vertical sense.
4. In fifty-five encounters, the aircraft did not continue transmitting RA Reports to the ground for 18 seconds. The primary purpose of RA Reports is for monitoring purposes, and this issue does not affect the coordination process.
5. In eight encounters, during the 18 seconds following the RA, the aircraft downlinked RA Reports with fields set to zero. These fields should contain the last available RA information.
6. A version 7 aircraft sent an RA Broadcast message at the conclusion of an RA with information that had not been updated.

In summary, we did detect encounters which suggest aircraft equipment malfunctions which could lead to safety concerns (observation 1). Additionally, some observations (2 and 3) require additional investigation to determine whether or not they constitute a safety concern. We also found evidence of aircraft not transmitting certain messages which are used for RA monitoring, and aircraft sending messages with incomplete fields. While these last two issues are not in themselves a safety concern, it is important to understand their cause to ensure the issues are not indicative of larger issues. Lincoln Laboratory will contact the TCAS manufacturers and military installations involved; the FAA Certification Office will follow up with non-U.S. aircraft representatives.

### **3.2 TCAS Broadcast Interrogations**

TCAS Broadcast Interrogations are 1030 MHz UF16-32 interrogations transmitted at regular intervals by every TCAS. They contain the discrete address of the interrogating TCAS aircraft and are used by the TCAS Interference Limiting algorithms. Each TCAS monitors the receipt of such interrogations by its own Mode S transponder to determine number of other TCAS aircraft (NTA) within detection range. Once each second, each TCAS updates its NTA to be the number of distinct TCAS addresses monitored within the previous 20-second period. TCAS Broadcast Interrogations are transmitted at full power and are transmitted such that, for any other TCAS aircraft within 30 nmi and at any azimuth, the nominal rate of own TCAS Broadcast Interrogation Messages arriving at that TCAS is one every 8–10 seconds.

German monitoring has observed frequent aircraft that do not use the broadcast address (FFFFFF<sub>hex</sub>) in their TCAS Broadcast Interrogations. This would cause receiving transponders to fail to accept the transmission and thus fail to pass the information to the associated TCAS unit. This could result in an undercount of the number of TCAS aircraft in the vicinity. If this were an occasional occurrence, it would not be a cause for concern. If the problem persisted over time, it could impact Interference Limiting; i.e., TCAS could fail to reduce its surveillance interrogations sufficiently, possibly interfering with ground sensor surveillance performance.

#### **3.2.1 Results**

During the seven-day monitoring period (13–19 June 2010) covered in Section 4 of this report, there were 5,081,527 TCAS Broadcast Interrogations received. Of those, approximately 991 or 0.02% did not have the proper broadcast address (FFFFFF<sub>hex</sub>). This could be due to: (a) an error in transmission, (b) an error in reception by our 1030/1090 receiver, or (c) failure of the aircraft to use the correct broadcast address. It would be impossible to distinguish between (a) and (b) with the current receiver system. As mentioned in the previous report, the best way to detect the failure of an aircraft to use the correct broadcast address ((c) above) is to determine if the errors were spread out in time, or if they appeared to be coming from an individual aircraft at the rate of 8–10/sec. The messages with incorrect broadcast errors were examined and the arrival time between them was calculated. The result of this analysis found that rate of the messages did not correspond to the 8–10/sec rate, were randomly distributed in time, and separated in time enough to be transmitted from different aircraft. Thus, our conclusion is that no aircraft repeatedly failed to use the correct broadcast address.

### **3.3 Future Work**

We believe that the analysis reported in this section provides an in-depth coverage of 1030 MHz data related to TCAS air-air coordination and other communication. Future work is expected to investigate 29 observations made during the current monitoring period and to monitor 1030 MHz messages recorded at other TRAMS sites.

Additionally, we will explore whether the tools and information described in this section can provide additional information for the TCAS Operational Performance Assessment (TOPA) program. Downlinked RA Reports used by the TOPA program occur once per radar scan, typically every 4.6 seconds. In contrast, the 1030/1090 receiver typically records RA Reports sent to all Mode S radars

tracking the aircraft. In many areas of interest, overlapping radar coverage results in the reception of multiple RA reports in a given scan period. This provides finer grained information which may be useful to the TOPA program.

Furthermore, coordinated RA encounter transmissions provide information at an even finer detail. DF16 coordination replies occur once per second during TCAS-TCAS encounters. These replies are identical to surveillance replies except for the addition of the 56-bit coordination information. Thus, the coordination replies could provide one-second altitude and RA information to better recreate and/or understand the TOPA RA geometries.

This page intentionally left blank.

## 4. 1030/1090 MHz TCAS SURVEILLANCE ANALYSIS

### 4.1 Overview

As described in Section 1, the 1030/1090 MHz surveillance monitoring is intended to examine mainly TCAS air-to-air surveillance interrogations/replies and ground-to-air and air-to-ground surveillance interrogations/replies. The ultimate goals are:

1. to provide understanding of the contribution of TCAS to the RF environment, and
2. to provide understanding of manufacturers' TCAS surveillance implementations and their adherence to MOPS requirements.

Sections 4.2.1.1–4.2.1.3 below give an overview of all 1030/1090 MHz receptions, including identifying those that are TCAS-related. Section 4.2.1.4 focuses entirely on the air-to-air TCAS surveillance interrogations and replies.

The analysis for this report began by examining the four-month period March through June 2010. The month of June 2010 was chosen based on the high rate of 1030 and 1090 messages recorded. The detailed analyses described in 4.2.1.2 and 4.2.1.3 were performed twice: once for the week of 13–19 June and once for a two-hour period on 16 June 2010 from 16:00 to 18:00 UTC. Both time periods were chosen based on highest message rates and most complete recordings. The two-hour period is considered of most interest, primarily since day-night fluctuations are significant and averaging over a week can obscure detailed information. In addition, future 1030/1090 recordings at TRAMS sites are likely to produce at least a two-hour time period for comparison.

For the two-hour period chosen, there were 647 unique Mode S addresses observed; and of these, 486 (75%) were equipped with TCAS. This is lower than the equipage reported by the TCAS Operational Performance Assessment (TOPA) work. TOPA data is collected by short range (60 nmi) Mode S radars located in busy terminal areas where TCAS equipage would be expected to be high. The Thales receiver has a much longer range, and therefore has coverage of airspaces with higher transponder-only equipage.

### 4.2 Results

#### 4.2.1 Basic Statistics

##### 4.2.1.1 Receptions vs. Time

Figure 19 shows message receptions vs. time for the month of June 2010. The overall reception patterns appear reasonable and expected and lead to the following observations:

- A day-night pattern is clearly evident on every day. The night-time reception rate is much lower than the day-time reception rate.
- The measured 1030 and 1090 rates rise steeply in the morning, beginning around 6 am local time, and fall late at night, but not as steeply.
- A weekly pattern is also evident, with the rate of both Mode S interrogations and replies decreasing on the 5<sup>th</sup>, 12<sup>th</sup>, 19<sup>th</sup>, and 26<sup>th</sup> of the month which correspond to Saturdays.
- The high rates are not higher at the peak time of day, but are more spread out over the day. This is a saturation phenomenon that is expected.
- The 1030 Air Traffic Control Radar Beacon System (ATCRBS) reception rate remained relatively constant throughout the month. The largest contributor of 1030 ATCRBS receptions at

our location is the nearby Mode S radar, which sends 1030 ATCRBS interrogations at a constant rate regardless of the number of aircraft present.

- The white “cutout” present in all four charts on 26 June is due to a gap in data recording while the effects of the Mode S radar on the receiver were being examined.

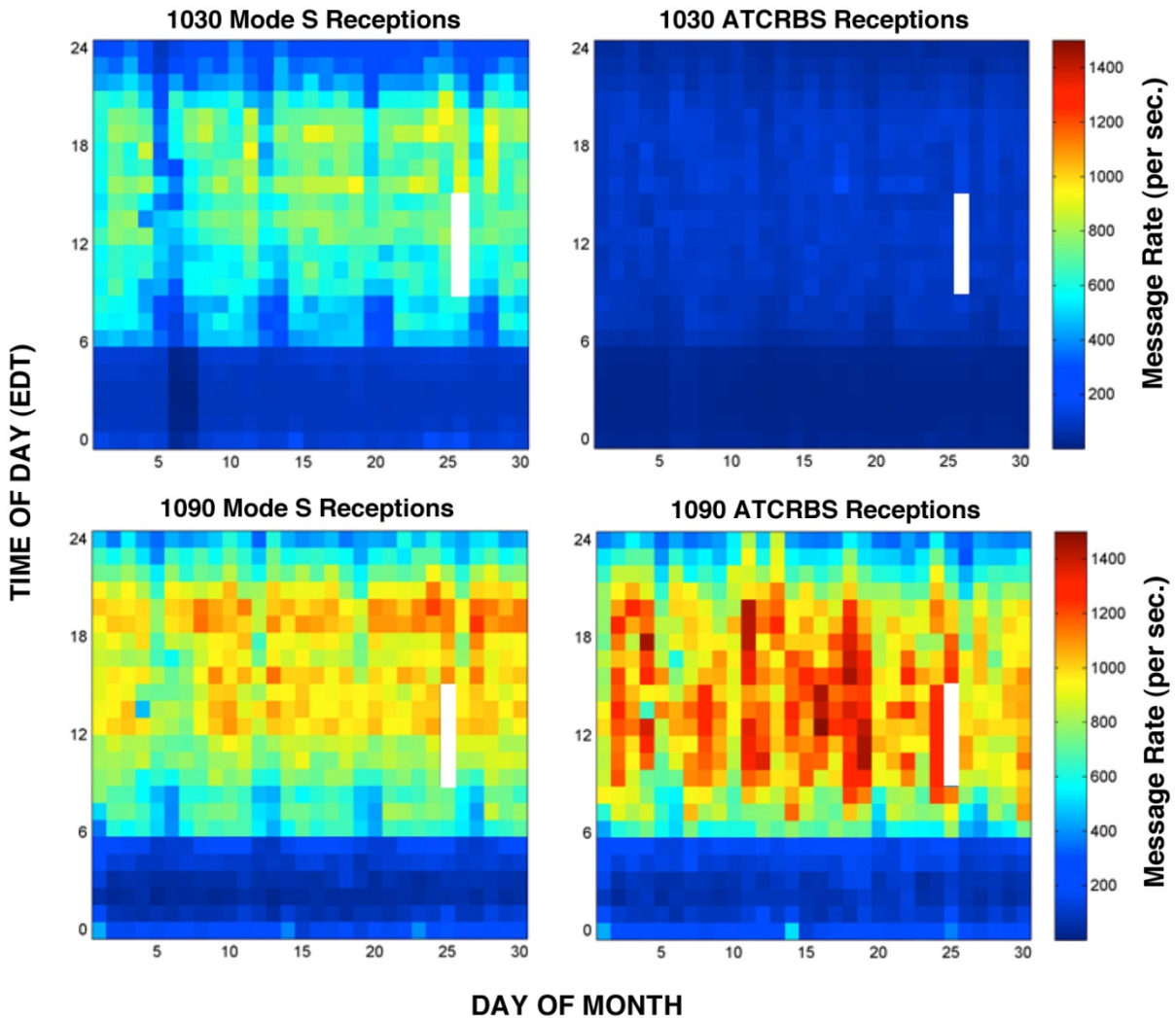

Figure 19. Message reception rate in time (1030 and 1090 MHz) June 2010  
Receiver threshold ~ -80 dBm at antenna

#### 4.2.1.2 Received Rates / Power Levels

The Thales receiver provides a measurement of received power level for each reception. Figure 20 shows the values of received power for both 1030 and 1090 MHz receptions for the two-hour period on 16 June 2010. These power levels are referred to the output of the antenna, meaning measurement has been adjusted to account for the 5.3 dBm cable loss (mentioned in Section 2.3.1) between the receiver and antenna, but not the gain of the antenna. The antenna has an elevation dependent pattern, with the gain varying between +7 dBm and +9.5 dBm. In these histograms each bar gives the receptions in a 1-dB band

of power values. All receptions were counted, including both ATCRBS and Mode S. The number of receptions in each 1-dB band was then divided by the time period to calculate the average reception rate during that time, which is plotted vertically. The 1030 and 1090 bars are superimposed to allow for easy comparison. For example, at  $-80$  dBm, the 1030 reception rate is 50 messages/sec and the 1090 reception rate is 97 messages/sec.

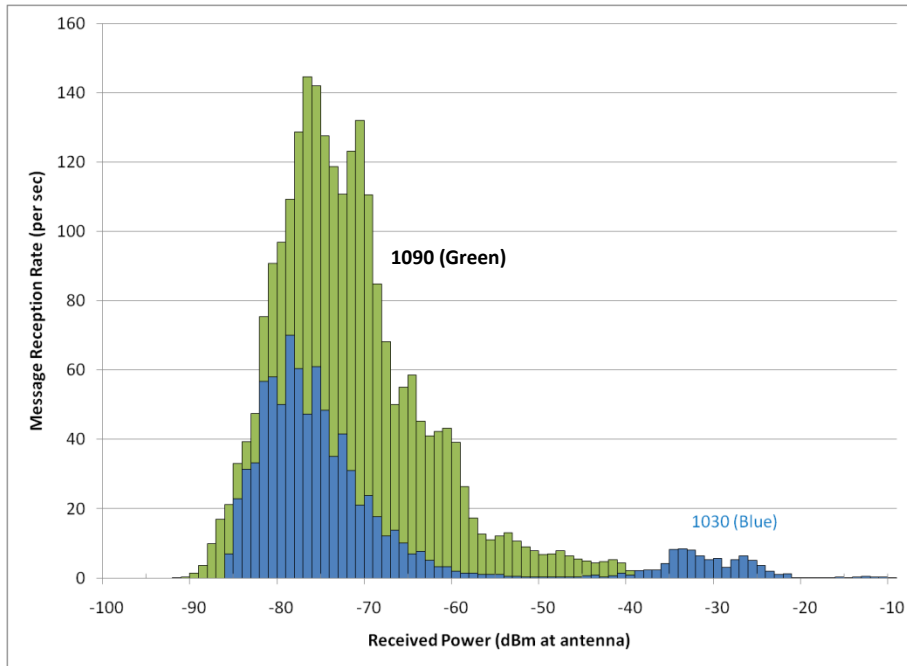

Figure 20. Received message power, 16 June 2010, two-hour period

The shapes that appear in these distributions are familiar. Going toward the left, there is a gradual increase, then a peak, and then a steep decrease. The steep decrease can be a result of the receiver threshold, which is approximately  $-80$  dBm referred to the antenna for this Thales receiver installation. Line-of-sight may also be a reason for the steep decrease on the left, because weaker reception power corresponds to aircraft at longer ranges. Moving to the right side of the graph, the 1030 MHz rate is increased from  $-40$  dBm to  $-22$  dBm. These increases are most likely a result of receiving interrogations from the Lincoln Mode S radar which is located  $\sim 200$  ft from the Thales antenna and would only affect the 1030 message rate. In fact, the 1090 message rate is near zero above  $-40$  dBm.

When the data in Figure 20 is accumulated, the results are provided in the familiar form showing reception rate vs. power, plotted in Figure 21. Each point gives the total reception rate including all power levels equal to or stronger than the abscissa value. This is the standard form used for reporting fruit rate measurements and interrogation rate measurements and was included in the previous monitoring report.

Comparing these measured rates with the previous reporting period, we see that these new measurements are higher. For example, for power levels of  $-80$  dBm and stronger, the combined ATCRBS and Mode S 1090 MHz rate shown here is 2059/sec. As reported in the previous monitoring report, the combined ATCRBS and Mode S reception rate for that power level was about 1320/sec. This result is not surprising given that the receiver was relocated to give better coverage and this period was chosen for its high activity.

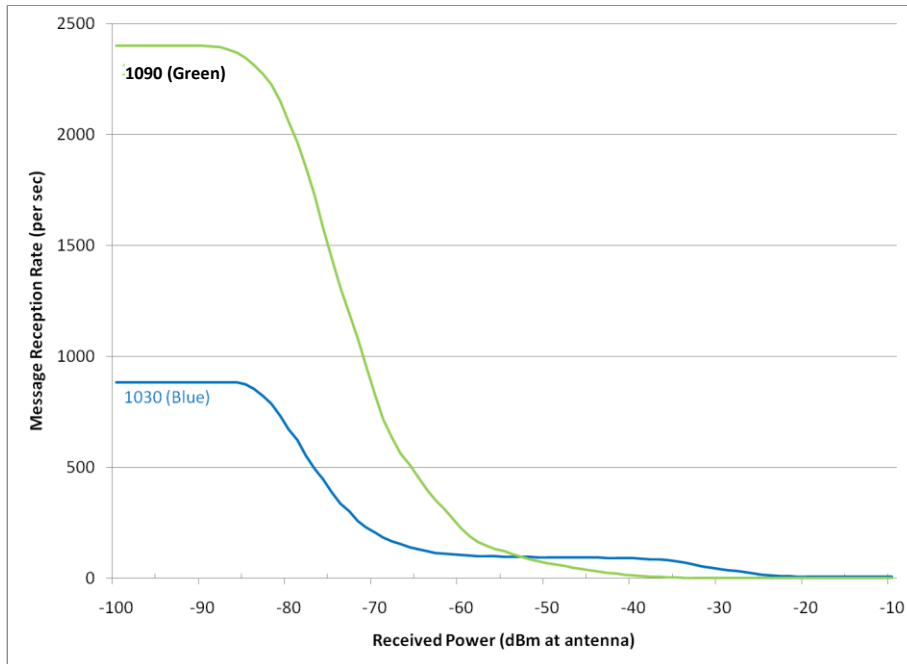

Figure 21. Cumulative received power, 16 June 2010, two-hour period

#### 4.2.1.3 Message Receptions by Type and Format

Received 1030/1090 transmissions are of two main types: ATCRBS and Mode S, as shown in Figure 22. ATCRBS transmissions are used only for surveillance: 1030 MHz ATCRBS transmissions are surveillance interrogations, either ground-to-air (from ATC ground sensors) or air-to-air (from TCAS); 1090 MHz ATCRBS transmissions are aircraft surveillance replies. Mode S transmissions can be either short (56 bits, containing surveillance information only) or long (112 bits, containing surveillance information plus a 56-bit message field). The different types of Mode S transmissions, i.e., Mode S formats, are shown in Table 4.



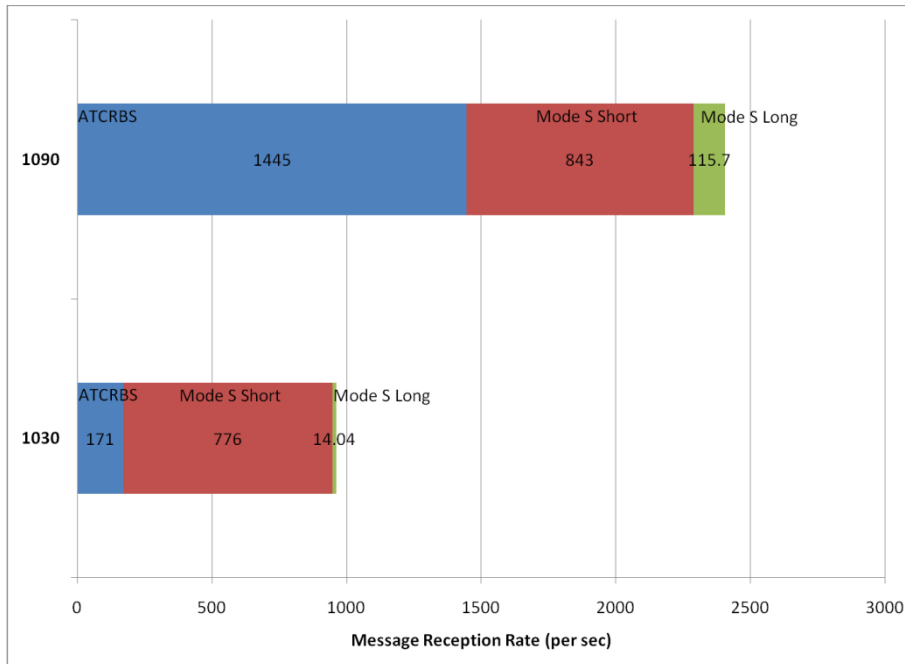

Figure 22. Message receptions by type, 16 June 2010, two-hour period

Table 4. Mode S Formats

**1030 MHz Uplink Formats (UF) - Interrogations**

	UF#	Link	Use
Short	0	Air-to-air	TCAS surveillance
	4	Ground-to-air	Ground Surveillance (altitude)
	5	Ground-to-air	Ground Surveillance (identity)
	11	Ground-to-air	Ground acquisition of aircraft's Mode S address
Long	16	Air-to-air	TCAS coordination, TCAS broadcast, RA broadcast
	20	Ground-to-air	Ground surveillance (altitude) + 56-bit message field <sup>1</sup>
	21	Ground-to-air	Ground surveillance (identity) + 56-bit message field <sup>1</sup>

<sup>1</sup> Used for Traffic Information Service (TIS)

**1090 MHz Downlink Formats (DF) - Replies**

	DF#	Link	Use
Short	0	Air-to-air	TCAS surveillance
	4	Air-to-ground	Ground Surveillance (altitude)
	5	Air-to-ground	Ground Surveillance (identity)
	11	Air-to-ground	Acquisition reply to ground
	11	Air-to-air	Acquisition squitter (TCAS acquisition of aircraft's Mode S address)
Long	16	Air-to-air	TCAS coordination
	17	Any <sup>2</sup>	Extended squitter (1090 implementation of ADS-B)
	20	Air-to-ground	Ground surveillance (altitude) + 56-bit message field <sup>3</sup>
	21	Air-to-ground	Ground surveillance (identity) + 56-bit message field <sup>3</sup>

<sup>2</sup> Could be air-to-air, air-to-ground, or ground-to-air

<sup>3</sup> Used for RA Reports, Data Link Capability Report, etc.

The reception rates for the different Mode S message formats are shown in Figure 23. The two highest rates are associated with 1090 MHz DF11 transmissions and 1030 MHz UF0 transmissions. DF11 transmissions are of two types: acquisition squitters, which contain the transponder’s 24-bit discrete Mode S address and which are sent once per second by every Mode S transponder, and All-Call replies to ground sensor UF11 surveillance interrogations. DF11 bits indicate whether the transmission is a squitter or a reply to the ground. From the figure, 342 messages/sec (72%) are All-Call replies and 134 messages/sec (28%) are acquisition squitters.

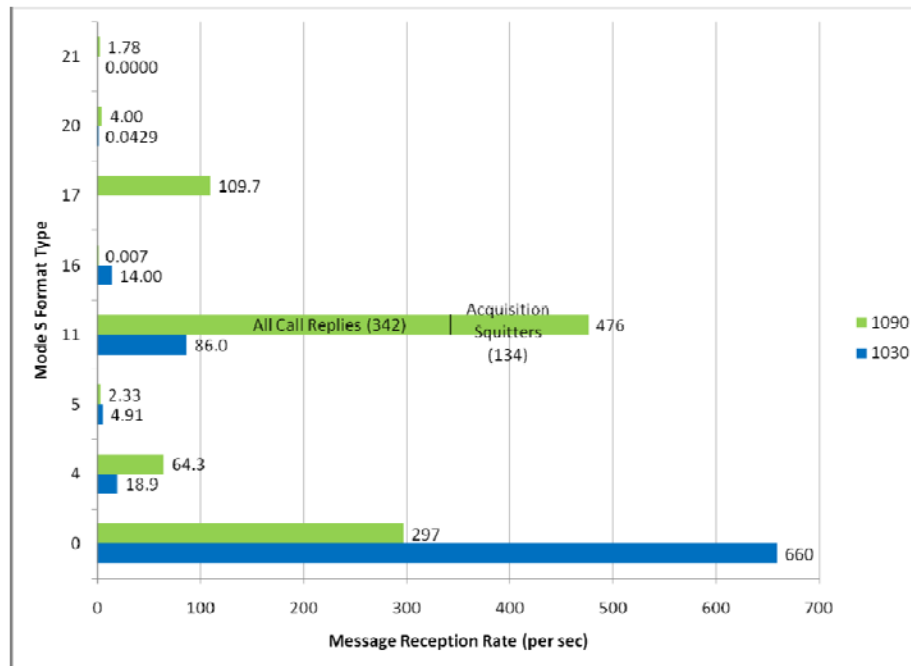

Figure 23. Mode S message reception rate by format, 16 June 2010, two-hour period

The largest reception rate is associated with UF0 transmissions, i.e., TCAS surveillance interrogations. As shown, the rate of DF0 transmissions, i.e., TCAS surveillance replies, is around half the TCAS interrogation rate. This will be examined further in the following section. Referring to Figure 23, it is important to understand that although TCAS signals account for a majority of the overall 1030/1090 MHz signals, the TCAS contribution to the 1030/1090 MHz spectrum is, in absolute numbers, very small. For example, using 35 microseconds for the duration of a 1030 MHz Mode S transmission, 60 microseconds for the duration of a short 1090 MHz Mode S message, and 120 microseconds for the duration of a long 1090 message, we can generate the following table.

Table 5. TCAS Contribution to the 1030/1090 MHz Spectrum

Mode S Reception Type	Rate (msg/sec)	Percent of timeline
TCAS 1030	674	2.4%
Total 1030	784	2.7%
TCAS 1090	297 (short)	1.8%
Total 1090	839 (short), 116 (long)	6.4%

#### 4.2.1.4 Examination of UF0 and DF0 Messages

As mentioned in Section 4.1 above, the second goal of this report was to study the TCAS surveillance interrogations (UF0) and the replies to those interrogations (DF0). For this work it would be very beneficial if UF0s could be attributed to specific aircraft and thus the surveillance performance of that aircraft's TCAS could be inferred. However, due to the nature of the Mode S protocol, when a TCAS sends a UF0 interrogation to another aircraft, it puts the receiving aircraft's Mode S address into the message. When the aircraft replies with a DF0, it puts its own address into the reply. Thus, there is no mechanism to determine which TCAS aircraft sent the UF0 that generated a DF0 reply. Therefore, examination is best performed by focusing on the receiving aircraft.

An examination was carried out for a one-hour period of data on 11 May 2010. This day was chosen because the Lincoln Mode S radar had been configured for one day to operate at a maximum range of 200 nmi instead of the typical 60 nmi. The message rates for UF0 and DF0 receptions were calculated by summing the number of received messages in a five second period, dividing by the number of aircraft in that five second period, and then dividing by five seconds. This yields an average number of messages per second per aircraft, which is shown in Figure 24. Shown in Figure 25 is the number of Mode S and TCAS aircraft for the same time period.

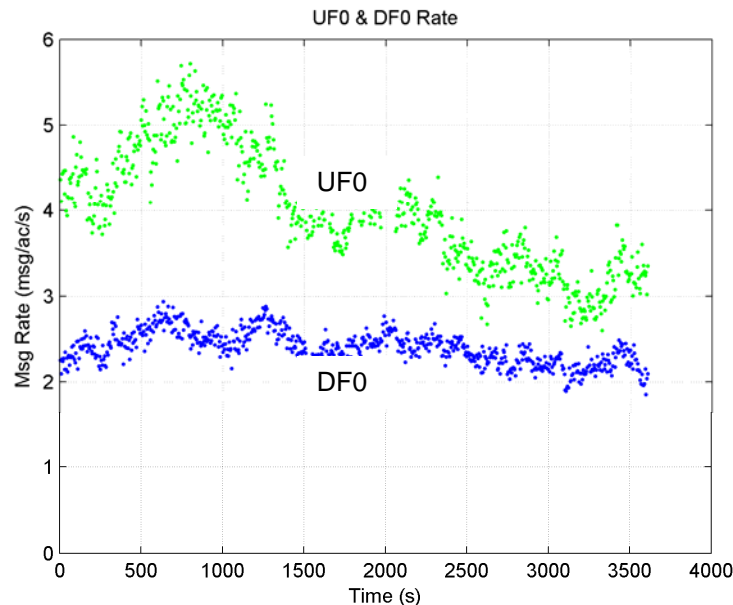

Figure 24. UF0 and DF0 messages per aircraft per second, 11 May 2010 19:00 UTC

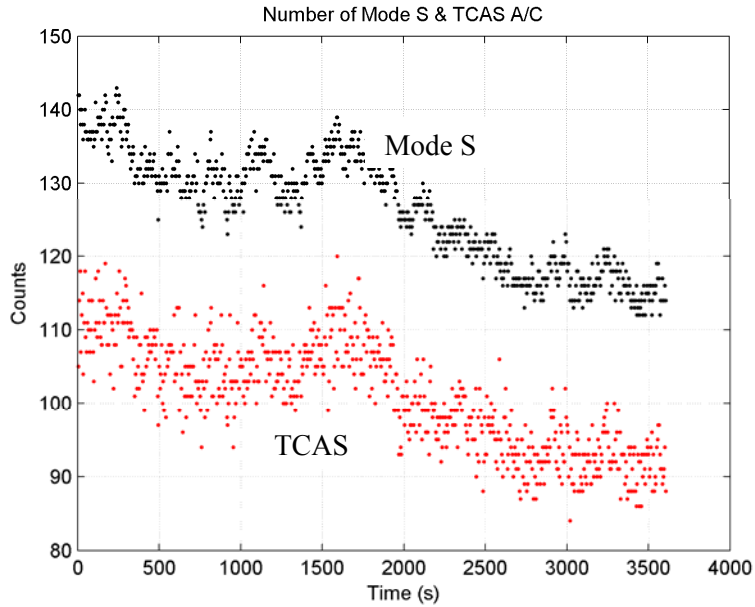

Figure 25. Number of Mode S and TCAS equipped aircraft, 11 May 2010 19:00 UTC

The DF0 reply rate varies between 2 and 3 messages/sec per aircraft and agrees well with the rate of 2.4 messages/sec shown in Section 2.4. The UF0 interrogation rate varies from 2.6 messages/sec per aircraft at its lowest to 5.8 messages/sec per aircraft at its highest and is always greater than the DF0 reply rate. The most likely explanation for the higher UF0 rate is re-interrogations. Re-interrogations could be caused by interference in receipt of the interrogations or replies, or to TCAS surveillance algorithms that allow interrogations to aircraft too far away to reply.

Of particular interest is the peak from 500 to 1000 seconds. Shown below in Figure 26 is a plot of the number of uniquely addressed Mode S UF0 interrogations and the number of uniquely addressed Mode S DF0 replies. These represent the number of unique aircraft being interrogated and the number of unique aircraft replying, respectively.

From the figure, it can be seen that the number of uniquely addressed DF0 replies is declining from 0 to 1000 seconds, which is consistent with the number of Mode S aircraft shown in Figure 25. However, the number of uniquely addressed UF0 interrogations remains relatively constant for the same time period. In other words, the same number of aircraft are being interrogated while at the same time the number of aircraft replying is declining. Thus, because the interrogation rate during this time (shown in Figure 24) increases, and the same number of aircraft are being interrogated, the increase must be due to the same aircraft being interrogated at a higher rate. Since the number of aircraft replying is declining, this must be due to re-interrogations as mentioned above.

To further examine this one-hour period, Figure 27 shows the range distribution of Mode S aircraft from the Lincoln Mode S radar. During the period of the increased UF0 interrogation rate, there is a high density of Mode S aircraft within 30 nmi of the Mode S radar. This high density is most likely the cause of the high UF0 rate shown above.

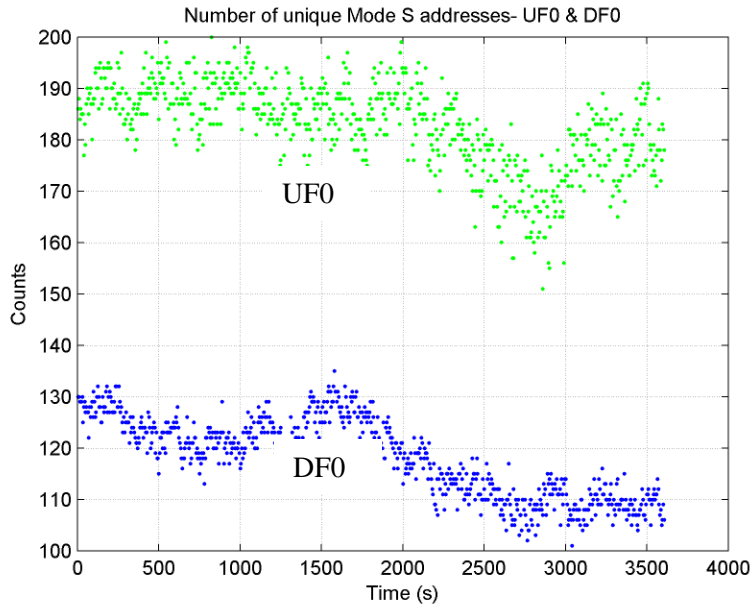

Figure 26. Number of unique Mode S addresses in UF0 interrogations and DF0 replies, 11 May 2010 19:00 UTC

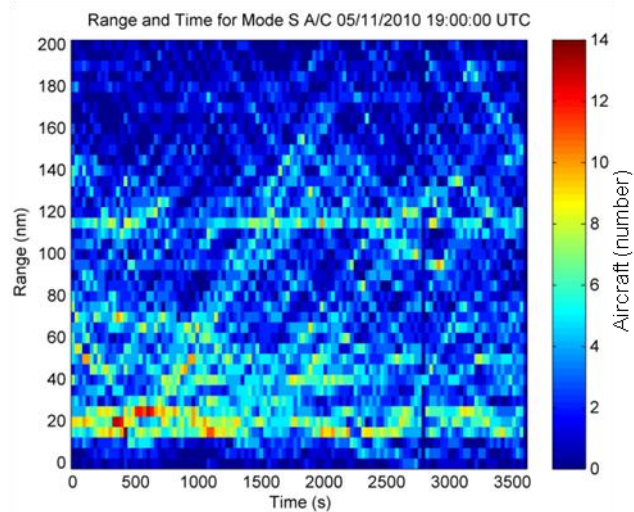

Figure 27. Range and time for Mode S aircraft from Lincoln Mode S radar, 11 May 2010 19:00 UTC

Several aircraft from the charts above were selected for individual analysis. Their UF0 and DF0 rates were calculated as previously mentioned, and two are shown in Figures 28 and 29 below. The first chart shows a well-performing aircraft, as the number of UF0s being sent to it is correlated with the number of DF0 replies being transmitted. The decrease in DF0s to near zero on the right side of the chart is due to the aircraft landing at Hanscom Field. The increase in UF0s at the same time is likely due to other TCAS aircraft trying to re-acquire the track after the aircraft lands.

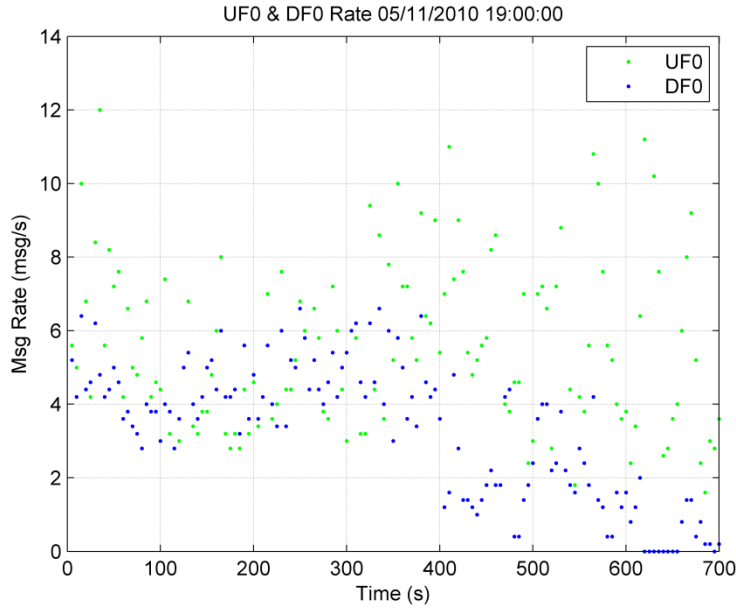

Figure 28. UF0 and DF0 rate for one aircraft (expected behavior)

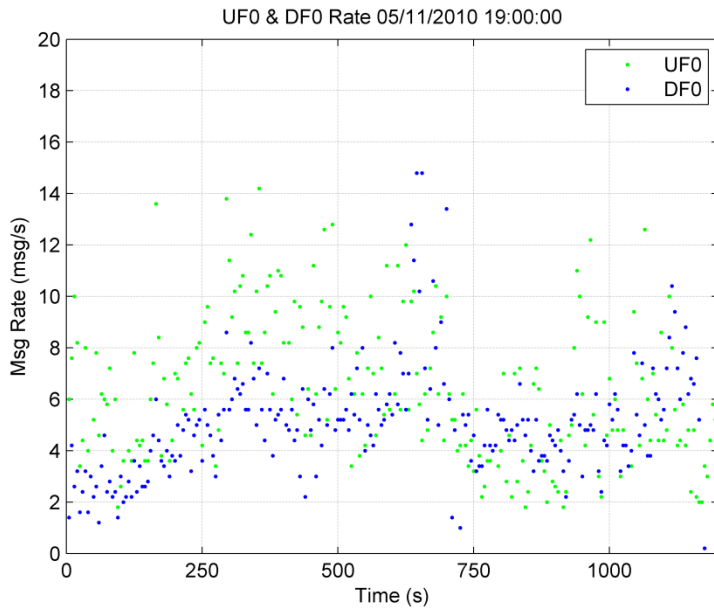

Figure 29. UF0 and DF0 rates for one aircraft (unexpected behavior)

Figure 29 shows an example of an aircraft that demonstrates unexpected behavior. Between approximately 600 and 700 seconds the rate of DF0 replies suddenly jumps to 15 msg/sec, which is much higher than average and above the UF0 rate. It is unclear what would be causing this behavior, and thus this aircraft is going to be the subject of further investigation. Future work will focus on automating the process of identifying aircraft that have unexpected behavior and need further investigation to determine the cause.

### **4.3 Future Work**

A well-defined baseline has been established for the receiver's current location, and its performance as a system has been validated. Also, a significant toolset for manipulating and analyzing the data has been developed. Future plans call for limited periods of 1030/1090 MHz data recording at various TCAS RA Monitoring System (TRAMS) sites throughout the National Airspace System (NAS). With the monitoring toolset, large amounts of collected data can be examined quickly to determine overall statistics and to locate time periods of particular interest for detailed study.

This page intentionally left blank.



## 5. 1090 MHz EXTENDED SQUITTER ANALYSIS

### 5.1 Overview

1090 MHz monitoring allows examination of 1090 MHz ADS-B transmissions which are not recorded by Mode S ground sensors. If ADS-B data is shown to meet certain criteria, this data will likely be used to enhance future collision avoidance systems.

Squitters are Mode S downlink replies that are broadcast by an aircraft’s Mode S transponder at specific intervals. There are two types of squitters: short (56-bit) DF11 transmissions or “acquisition squitters” which contain the aircraft address and are transmitted once per second by every Mode S transponder and long (112-bit) DF17 transmissions or “Extended Squitters”(ES) which contain the same information as short squitters plus an extra 56-bit message field. The content of the ES 56-bit message field determines the transmission rate for the message.

The initial 1030/1090 MHz monitoring report included data recorded at the Lincoln Laboratory Flight Facility during Thanksgiving week 2009. The initial report listed five tasks for future 1090 ES work. For this second report, a large focus has been on the first of the five tasks, i.e., to make the 1090 ES processing more efficient to enable processing of a larger volume of data. In addition, we made progress towards the fourth task, i.e., to show trends in equipage. This was accomplished by comparing the statistics generated during March–June 2010 to the statistics generated during the first reporting interval. Finally, Section 5.2.5 briefly addresses the third task, checking for consistency among reported information.

After the initial monitoring report, the Thales receiver was relocated to Katahdin Hill in Lexington, near the Lincoln Laboratory–operated Mode S sensor. An additional focus for this report has been to understand the impact of relocating the receiver.

The minimum ADS-B message set, as defined by RTCA DO-260B [4] and FAA Technical Standard order TSO-C166b [5], consists of six basic ES messages:

**Table 6. Basic Six Extended Squitter Messages, or Minimum ADS-B Message Set**

Mode S Transponder Register Number	Register Name	Frequency of Transmission
0,5	Airborne Position	2/sec
0,6	Surface Position	2/sec if moving; every 5 sec if stationary
0,8	Aircraft Identification and Category	every 5 sec if moving; every 10 sec if stationary
0,9	Airborne Velocity	2/sec
6,5	Aircraft Operational Status	Version 0: every 1.7 sec Version 1: every 2.5 or 0.8 sec
6,1	Extended Squitter Aircraft Status*	event driven

\*previously called Emergency/Priority Status

## 5.2 Results

### 5.2.1 *Extended Squitter Availability*

For our second analysis period (March–June 2010) we established a new technique for studying the availability of Extended Squitter messages. This technique involves tabulating for each hour of each day the number of unique Mode S addresses transmitting short squitters (DF11) and the number of aircraft transmitting Extended Squitters (DF17s). These results are presented in color-coded tables with the row representing local time and the column representing the day of the month. Using this technique, it is possible to show results for the entire four-month analysis period on a single page. The counts of Extended Squitter transmitting aircraft are show below in Figure 25. Looking at Figure 25 it is possible to observe trends in the four month time period without needing to focus on the counts values in the individual elements of the tables. Extended Squitter counts for just the month of April are shown in Figure 26.

For the four-month period presented in Figure 30, we observe a gradual increase in the number of Extended Squitter-capable aircraft from March through June. The major exception to this trend occurs in mid-April during the period of volcanic activity in Iceland. Figure 31 shows just the month of April 2010. Starting on 15 April the airspace in the United Kingdom was closed for several days resulting in a significant drop in the number of Extended Squitter-capable aircraft in our 1090 MHz data. Because of this interesting event, the week of 11–17 April was selected for in-depth study. The data from the first part of the week represents “business as usual” while the data from 15–17 April allows us to study Extended Squitter equipage in the vicinity of our Thales receiver without the contribution of the UK and several core European countries.

		March 2010																								April 2010																								May 2010																								June 2010																																																																																																																																																																																																																																																																							
		Midnight												6:00												Noon												18:00												Midnight												6:00												Noon												18:00												Midnight												6:00												Noon												18:00																																																																																																																																																																																																											
		Eastern Time																								Eastern Time																								Eastern Time																								Eastern Time																								Eastern Time																								Eastern Time																								Eastern Time																								Eastern Time																								Eastern Time																								Eastern Time																								Eastern Time																								Eastern Time																																																																							
		Date																								Date																								Date																								Date																								Date																								Date																								Date																								Date																								Date																								Date																								Date																								Date																								Date																								Date																							
38	20	33	24	26	24	35	25	29	26	44	71	48	59	58	47	54	50	67	57	68	58	47	45	46	51	67	51	41	44	44	47	47	53	41	42	36	30	34	28	40	42	31	42	46	21	22	25	27	27	33	41	49	40	44	66	49	36	32	38																																																																																																																																																																																																																																																																																						
27	18	10	16	23	20	17	14	32	35	36	40	28	18	22	24	37	14	22	24	34	43	26	20	24	34	26	20	20	15	11	8	14	16	14	17	8	12	11	13	14	9	5	10	10	10	7	14	14	10	12	9	12	19	20	20	15	21	8	10																																																																																																																																																																																																																																																																																						
13	11	0	3	6	11	11	15	10	8	15	13	20	15	9	11	10	14	37	21	14	5	14	8	19	18	19	6	7	11	8	14	16	14	17	8	12	11	13	14	9	5	10	10	10	7	14	14	10	12	9	12	19	20	20	15	21	8	10																																																																																																																																																																																																																																																																																							
13	15	12	12	18	11	11	14	20	16	17	13	32	11	11	14	13	10	12	14	13	11	12	15	19	15	11	11	19	19	17	15	12	10	13	16	13	11	15	17	8	9	10	15	19	16	15	23	16	15	17	9	8	9	10	15	19	16	15	17	16																																																																																																																																																																																																																																																																																					
19	18	21	40	13	22	16	24	23	25	17	20	12	18	17	15	19	13	18	15	13	20	24	14	20	14	20	20	29	31	19	25	19	28	25	24	23	17	15	20	26	23	21	18	18	16	8	20	24	33	19	25	14	17	25	22	24																																																																																																																																																																																																																																																																																									
21	30	32	31	22	26	21	31	27	42	46	29	15	18	29	34	38	29	34	42	38	28	24	34	35	38	44	29	31	20	31	22	24	42	36	33	39	22	22	19	35	43	31	33	24	21	20	31	40	44	37	29	16	22	39	33	33																																																																																																																																																																																																																																																																																									
47	43	60	48	38	66	30	51	55	61	54	48	42	25	39	52	47	47	46	47	40	68	39	48	30	34	45	44	41	47	48	45	34	49	42	53	53	33	36	34	45	52	39	41	35	36	40	49	55	39	29	31	49	60	42	47																																																																																																																																																																																																																																																																																										
27	39	45	49	43	43	40	34	44	36	57	47	54	36	26	47	68	70	65	72	40	56	44	49	45	57	35	50	52	40	46	55	112	43	47	62	59	65	43	46	33	48	68	55	70	47	51	50	33	62	63	47	43	63	62	47																																																																																																																																																																																																																																																																																										
36	40	44	52	36	60	36	43	54	43	60	38	37	32	44	41	50	45	46	41	37	43	40	40	57	47	35	46	43	40	45	71	52	42	51	56	60	47	54	45	54	53	50	60	44	45	40	49	51	45	48	61	43	51	42	50																																																																																																																																																																																																																																																																																										
39	55	48	57	68	48	60	38	59	54	59	63	35	34	43	39	57	39	45	54	29	41	44	58	32	40	37	57	52	64	51	53	43	56	68	61	63	44	64	43	58	59	60	39	61	37	32	36	53	20	52	47	54	47	55																																																																																																																																																																																																																																																																																											
56	52	50	55	69	56	60	54	68	59	69	58	39	51	52	55	63	51	46	52	55	68	50	45	38	43	40	60	58	76	64	67	64	47	57	62	58	68	57	54	62	70	59	34	34	37	30	41	47	57	61	57	53	61	44																																																																																																																																																																																																																																																																																											
73	62	59	100	113	79	72	104	118	106	109	69	66	46	65	80	61	68	53	62	56	48	56	58	71	48	65	54	46	60	58	76	67	64	67	74	76	84	83	82	79	70	59	81	81	81	111	42	33	35	38	47	59	81	91	135	77	57	77	119	85	0																																																																																																																																																																																																																																																																																				
116	113	123	91	81	134	87	70	87	91	98	145	72	128	73	90	95	118	70	73	76	95	133	119	114	100	72	98	108	116	149	117	123	84	123	131	157	170	156	102	97	92	139	149	92	57	41	31	38	52	101	150	174	109	102	130	135	98	142	46																																																																																																																																																																																																																																																																																						
79	85	75	87	104	95	119	94	84	77	80	98	99	98	73	82	80	72	100	108	111	58	71	85	83	100	82	127	81	86	84	95	112	94	91	95	87	94	96	100	129	136	129	94	90	98	100	57	40	60	89	86	106	103	92	124	90	83	96	91																																																																																																																																																																																																																																																																																						
87	89	79	88	103	106	87	86	79	83	88	87	100	126	86	82	85	80	94	101	89	77	79	88	80	100	81	96	82	77	92	92	114	114	135	98	95	84	98	103	100	96	83	85	89	91	63	61	45	55	74	85	100	99	103	88	86	80	77	94	41																																																																																																																																																																																																																																																																																					
64	73	67	77	97	89	70	65	59	91	120	103	87	114	86	101	82	80	94	86	80	85	79	95	89	78	72	74	90	89	123	81	79	80	88	69	78	80	75	71	58	66	67	115	51	78	46	50	74	100	80	133	80	70	74	82	78	73																																																																																																																																																																																																																																																																																								
55	70	50	62	58	66	60	73	46	61	46	68	103	92	62	102	78	103	73	67	66	70	67	89	110	88	55	54	60	58	94	69	68	62	75	91	64	65	87	51	50	50	68	56	41	50	69	51	60	82	118	85	69	69	50	58	49	52																																																																																																																																																																																																																																																																																								
102	81	107	88	91	74	121	82	72	70	78	98	77	60	67	61	97	71	93	62	94	93	85	57	64	67	74	96	93	83	73	106	132	81	72	70	97	81	79	82	72	109	117	84	75	60	62	70	59	111	72	92	102	91	106	82	89	68	80	97																																																																																																																																																																																																																																																																																						
111	116	128	119	118	119	136	134	133	131	144	127	96	115	104	161	120	131	123	128	116	124	126	124	131	128	147	153	128	158	157	188	143	136	150	139	138	154	148	140	143	139	147	138	113	70	48	52	72	107	161	161	139	209	152	143	148	151	143	235																																																																																																																																																																																																																																																																																						
95	94	100	90	87	86	105	111	107	114	110	116	114	106	118	115	122	121	133	125	121	129	126	116	134	116	130	115	116	130	100	132	112	113	125	113	123	102	106	110	100	108	112	55	52	34	44	65	74	136	146	125	112	117	133	114	120	116	111																																																																																																																																																																																																																																																																																							
73	77	71	85	84	66	90	92	72	88	85	94	71	99	107	101	91	102	106	108	106	107	91	96	104	93	90	89	108	91	92	104	108	93	94	86	97	89	101	96	81	90	91	87	89	52	36	43	50	64	95	108	99	90	92	92	95	108	99																																																																																																																																																																																																																																																																																							
86	84	78	88	87	61	91	94	87	92	76	53	87	91	96	79	84	81	65	78	98	82	74	86	81	65	72	95	84	85	103	96	81	76	96	81	95	81	95	106	88	69	78	99	81	73	47	42	28	32	62	57	96	99	87	79	75	85	92	87	97	87																																																																																																																																																																																																																																																																																				
54	46	61	54	55	62	63	66	61	82	74	57	90	94	77	84	78	89	73	75	82	78	73	85	66	75	79	72	69	79	81	79	56	69	63	76	80	63	60	69	65	61	53	26	43	33	27	53	73	68	80	64	67	89	59	62	76	71																																																																																																																																																																																																																																																																																								
2	4	6	8	10	12	14	16	18	20	22	24	26	28	30	32	34	36	38	40	42	44	46	48	50	52	54	56	58	60	62	64	66	68	70	72	74	76	78	80	82	84	86	88	90	92	94	96	98	100	102	104	106	108	110	112	114	116	118	120	122	124	126	128	130																																																																																																																																																																																																																																																																																	
28	37	31	29	33	32	42	37	55	48	57	48	55	39	74	53	54	52	50	48	31	45	55	35	37	33	47	67	50	42	45	42	40	45	42	48	63	47	38	40	60	43	50	55	81	41	45	49	42	34	46	51	46	71	63	62	52	56	65	64	55																																																																																																																																																																																																																																																																																					
21	22	14	15	18	11	20	26	37	26	35	27	30	20	46	24	30	21	18	21	13	28	24	25	20	19	22	45	19	27	17	18	24	19	24	22	29	17	20	21	22	16	26	18	20	23	17	19	16	22	21	31	24	42	25	23	31	37	30																																																																																																																																																																																																																																																																																							
16	11	6	16	8	9	14	31	37	20	13	10	16	10	18	11	6	5	9	18	7	16	14	13	14	23	6	7	16	6	9	17	15	8	14	16	13	7	16	12	5	10	8	12	15	13	12	11	9	19	16	10	16	19	14																																																																																																																																																																																																																																																																																											
12	7	12	14	20	14	18	14	22	24	16	17	15	18	21	20	14	19	17	9	18	21	16	21	13	14	15	12	21	23	17	13	15	18																																																																																																																																																																																																																																																																																																																

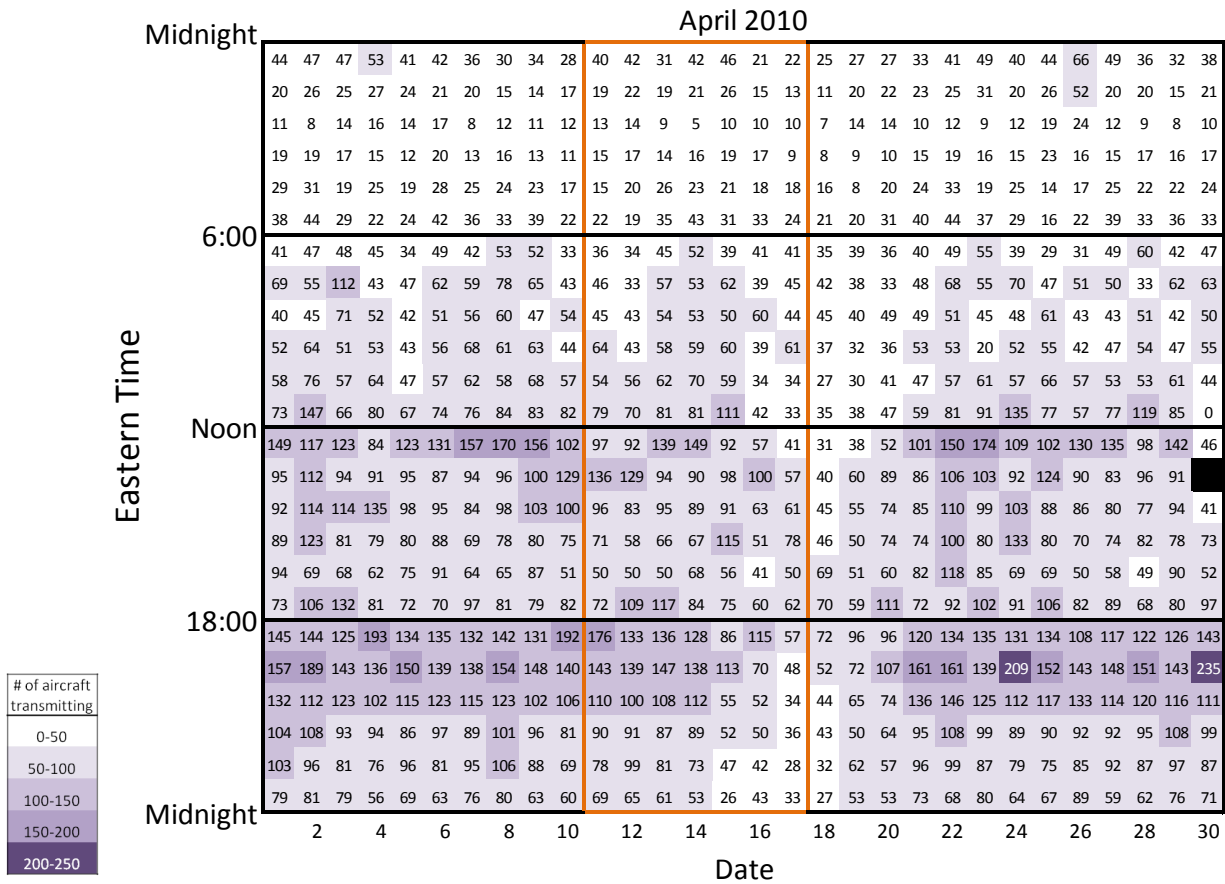

Figure 31. Counts of ES-transmitting aircraft, April 2010

As mentioned above, for each hour of each day we tabulated the number of unique Mode S addresses transmitting short squitters (DF11). For the in-depth study interval we tabulated the number of aircraft per hour per day transmitting Airborne Position Messages.

The percentage of ADS-B equipage per hour per day is easily derived from the DF11 and DF17 tables. Figure 32 provides tables A through D showing Extended Squitter aircraft count, Airborne Position Message count, short squitter aircraft count, and ADS-B equipage percent for the week of 11–17 April 2010.

Table A in Figure 32 includes all aircraft that transmitted any of the Minimum ADS-B message set. During 11–14 April there are periods of high ADS-B equipage in the early afternoon and in the early evening. Beginning 15 April the volcanic activity in Iceland closed the airspace over the United Kingdom (UK). The reduction in ADS-B equipped aircraft caused by the grounding of so many UK and European air carriers is clearly evident in the data from 15–17 April.

Table B includes only aircraft transmitting Airborne Position Messages. Note for every cell in Table A, the corresponding value in table B is lower. Also note the reduction in aircraft providing Airborne Position Messages corresponding to the grounding of international flights.

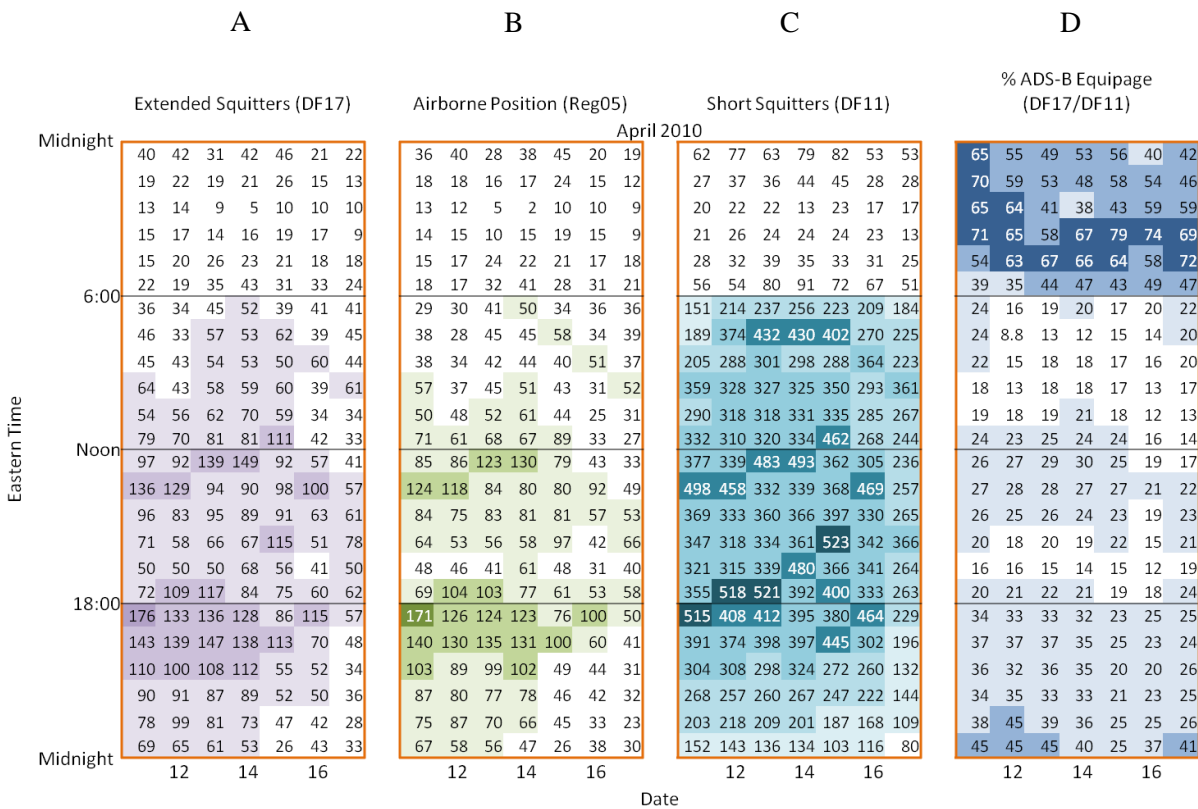

Figure 32. ES information for 11-17 April 2010

Table C includes all Mode S equipped aircraft observed each hour. Note there are peaks in aircraft counts where expected, i.e., between 6 AM and 7 AM, around noon, and from 5 PM to 7 PM.

Table D shows the percentage of ADS-B equipped aircraft per hour per day. In Table D the increase in percentage of ADS-B equipage from 11 PM through 6 AM is mostly caused by a decrease in the total aircraft population (Table C) without a corresponding decrease in the ES aircraft population. For example, from Table A on 11 April at midnight there are 40 ES aircraft and at 8 AM there are 45 ES aircraft. From Table C the number of Mode S aircraft at midnight is 62 and at 8 AM the number of Mode S aircraft is 205. The percent ADS-B equipage at midnight is 65, while the percent ADS-B equipage at 8 AM is 22. The ES aircraft population is relatively high between 11 PM and 6 AM because of the cargo aircraft operating during this time interval.

The following figures (Figures 33 and 34) show, by country, the number of unique Mode S aircraft observed during our in-depth analysis interval (April 11-17, 2010). The blue portions of the bars represent aircraft that were sending both acquisition squitters and Extended Squitters. The green portions of the bars represent aircraft sending only acquisition squitters. Figure 33 includes data from the five most frequently observed countries. The remaining countries are shown in Figure 34 for clarity.

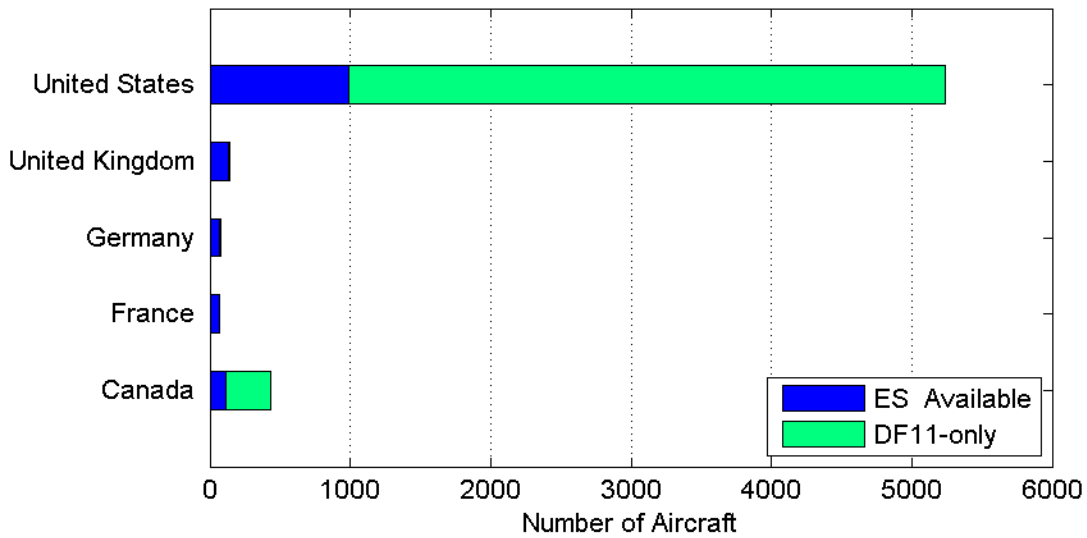

Figure 33. ES availability by country (highest counts)

Note in Figure 33 that the United States and Canada have a very low percentage of ES availability (17.8% and 26.5% respectively). In contrast, the United Kingdom has 89% ES availability, France has 98% ES availability and Germany has 86% ES availability.

Note that many countries in Figure 34 have a high percentage of ES availability. This is expected because a European ADS-B mandate is anticipated, and because ES is likely to have been implemented in conjunction with the 31 March 2008 ELS (Elementary Surveillance) mandate and/or the 31 March 2009 EHS (Enhanced Surveillance) mandate.

None: aircraft address did not correspond to any country's block of Mode S addresses

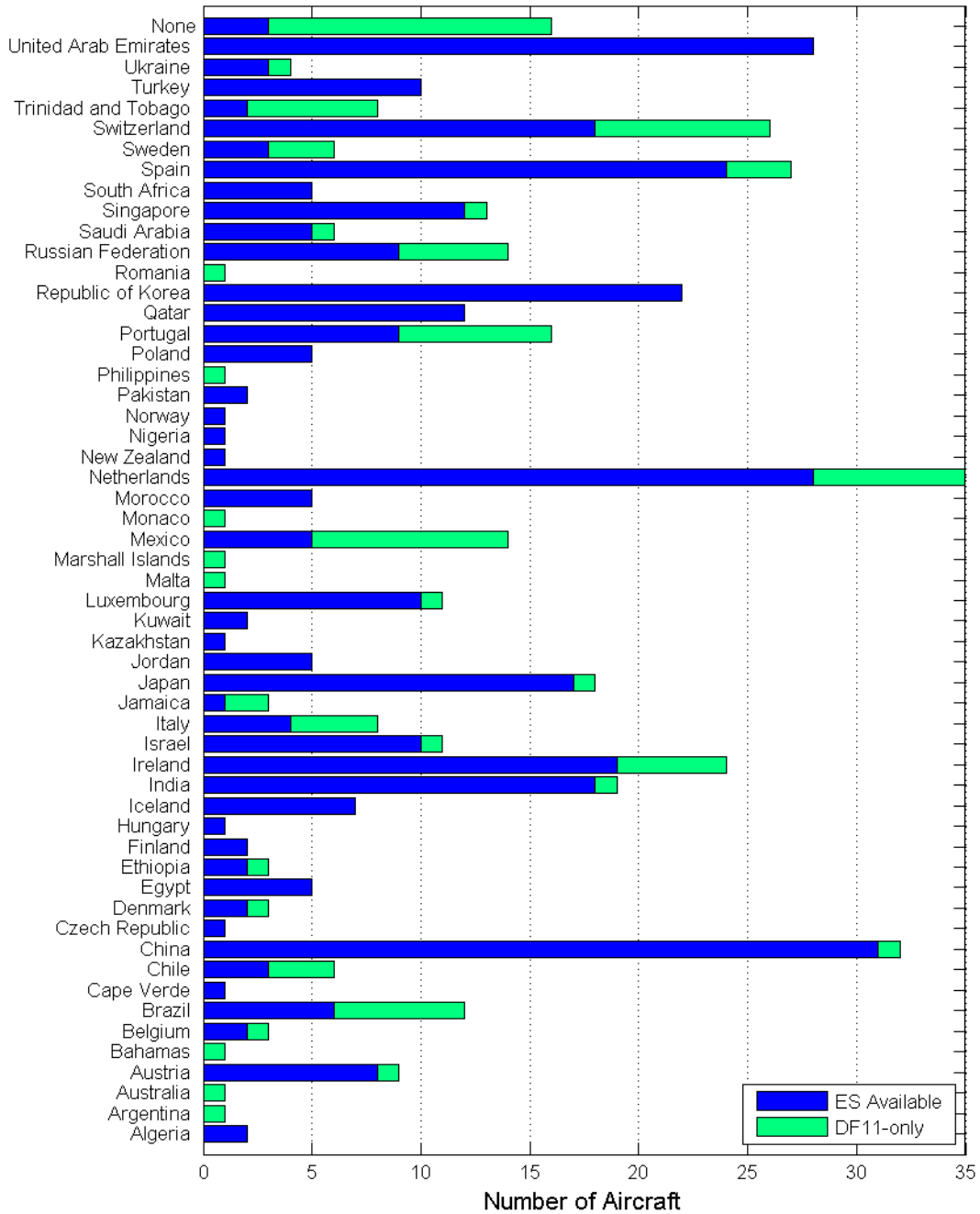

Figure 34. ES availability by country

Figure 35 below shows the percentage of Mode S equipped aircraft transmitting each of the Minimum ADS-B Messages, as well as the number of Mode S equipped aircraft transmitting any of the Minimum ADS-B Messages for 11–17 April 2010.

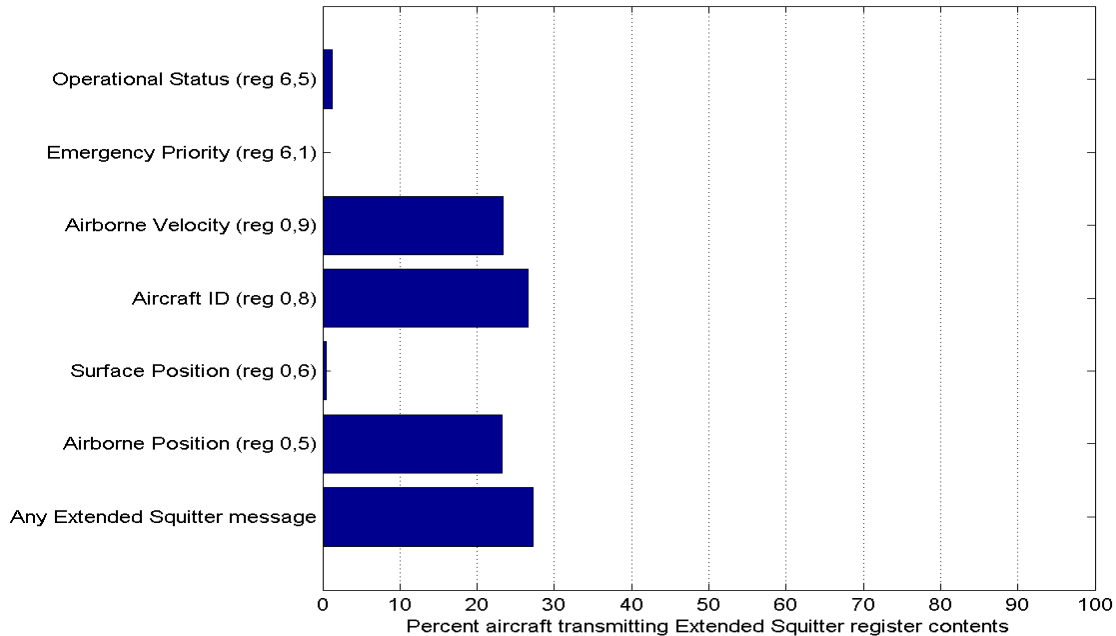

Figure 35. Aircraft transmitting Extended Squitter registers

Overall, for the entire week, only 25%–30% of the Mode S equipped aircraft within the coverage of our 1030/1090 receiver report at least some type of ES message. This figure looks similar to the corresponding figure from the first 1030/1090 MHz monitoring report [1]. There are still no Emergency / Priority (register 6,1) messages, and there are more aircraft transmitting Surface Position messages than in the first report. The weekly statistics provide an overall measure of ADS-B equipage in our vicinity. The hour by hour aircraft counts provide more detail regarding when the ADS-B equipped aircraft are actually observed each day. Referring to Figure 32, Table D between 23:00 and 6:00 up to 79% of the Mode S aircraft within coverage of our receiver report some type of ES message. This occurs because the overall number of Mode S aircraft is significantly reduced during this time (Table C) and because of the cargo aircraft operating during this time period.

### 5.2.2 Airborne Position Messages

Figure 36 provides a visual comparison of 2,085,374 Airborne Position Messages recorded 22 November 2009 while the Thales receiver was located at the Lincoln Laboratory Flight Facility and 2,638,337 Airborne Position Messages after moving the Thales receiver to the tower on Katahdin Hill. This represents an increase of more than 25% in received messages. Note as expected the Airborne Position Messages are received from farther away now that the Thales receiver is located on a hill which corresponds to a better line of sight.

Figure 37 provides a visual comparison between Airborne Position Messages received 11 April before the volcanic activity impacted trans-Atlantic air travel and 17 April after the volcanic activity closed airspace in the UK and parts of core Europe. The 17 April plot conveys a significant reduction in high altitude flights.



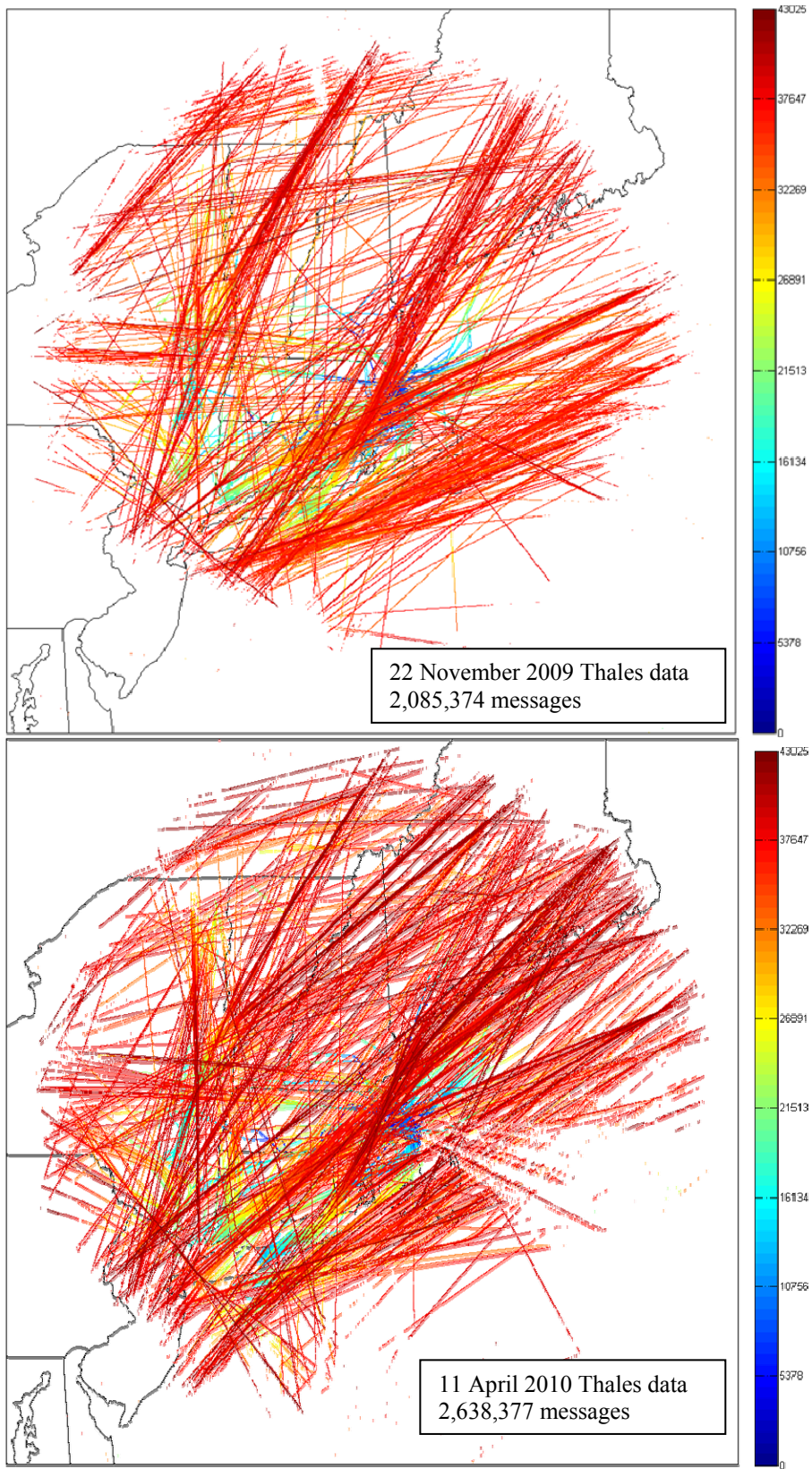

Figure 36. ES messages received (previous and current receiver locations)

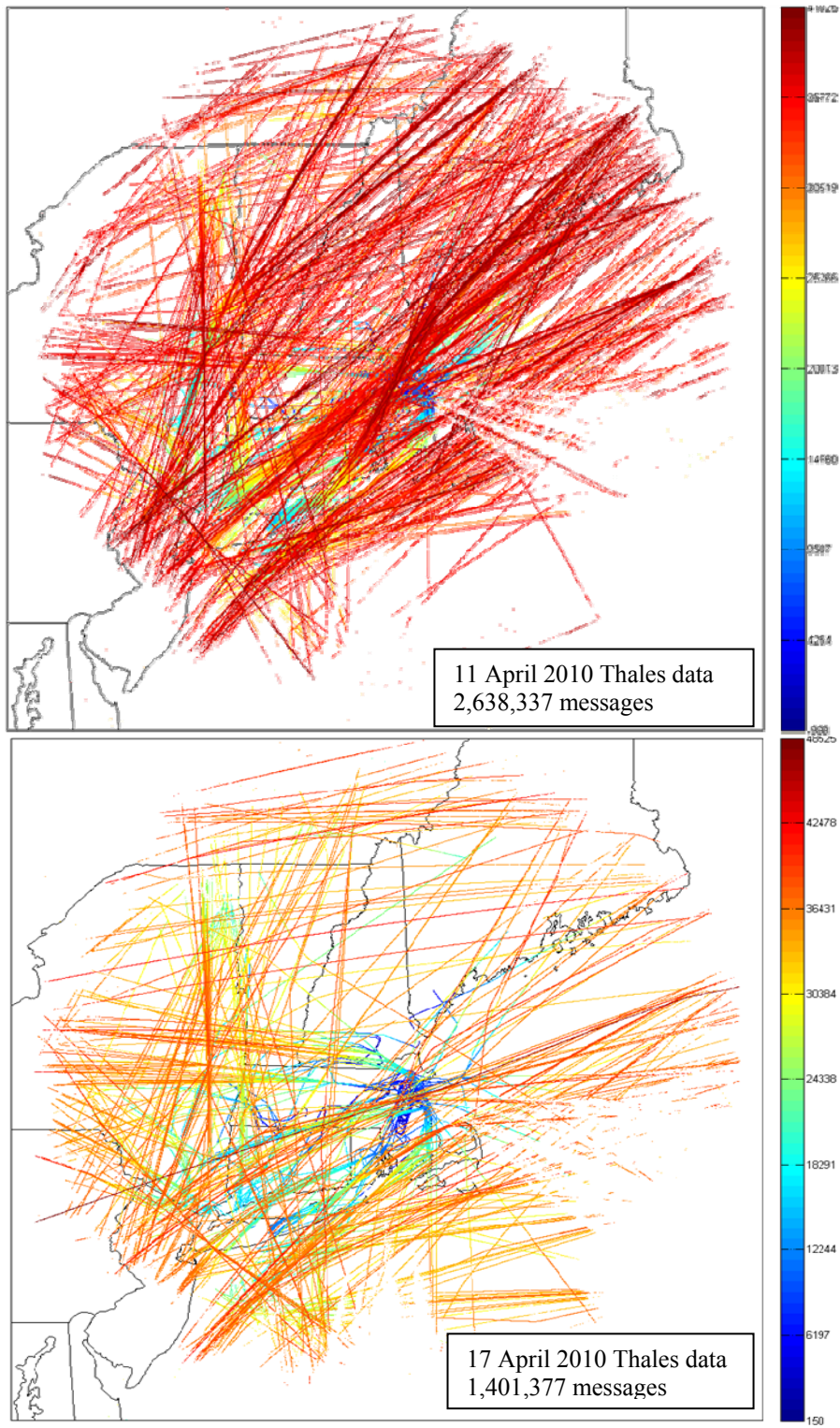

Figure 37. ES messages received (11 April and 17 April 2010)

### 5.2.3 Surface Position Messages

Surface Position Messages containing latitude, longitude and precision category information are transmitted by aircraft on the ground. Now that the Thales antenna is positioned on a hill, Surface Position Messages were observed from seventeen aircraft at Hanscom Field and from three aircraft at Worcester Airport. Single Surface Position Messages were received from two aircraft at Logan Airport. Twenty aircraft had Version 0 transponders (corresponding to RTCA DO-260) with Navigational Uncertainty Category (NUC) values ranging from 6 to 9; two had Version 1 transponders (corresponding to RTCA DO-260A). Both Version 1 transponder-equipped aircraft reported unknown Navigational Integrity Category (NIC).

Some of the Surface Position Messages correspond to the runways and taxiways at Hanscom airport; however, many Surface Position Messages are clearly incorrect. Given that the majority of the Surface Position Messages are provided by Version 0 transponders, the results shown in Figure 38 are not unexpected.



Figure 38. Sample Surface Position Messages at Hanscom Field

### 5.2.4 Aircraft Identification and Category Messages

The Aircraft Identification and Category Message contains a 48-bit identification field and a 3-bit aircraft/emitter category field. The identification field contains eight 6-bit characters, coded according to RTCA-DO181D [6], that normally hold the aircraft flight ID or call sign. This identification is expected to be presented on the pilot display. The identification is considered invalid if any of the 6-bit values do not decode to a valid character or if there are blank characters embedded in the identification field. Table 7 shows the number of valid and invalid Aircraft Identification Messages observed per day from 11–17 April. Table 8 shows a sample of the invalid aircraft identification strings identified in Table 7.

**Table 7. Aircraft Identification Messages**

Day	Valid Aircraft IDs	Invalid Aircraft IDs
11	1002	34
12	631	24
13	678	25
14	669	34
15	649	34
16	450	29
17	356	16

**Table 8. Sample Invalid Aircraft Identification Strings**

Invalid Aircraft Identification Strings observed during reporting period (April 11 – 17, 2010)				
#ANKE00	CA IA51	EIA512 I	EL#011 ?	KING 74
#ANKEE31	CGRC#	EIA512 L	EL#026	L#004
0A IA51	CNV 9632	EIA512 V	EL#027	N37N#
7A IA51	DUCE 22	EIA512 X	EL#028	N919#C
9A IA51	EIA 1251	EL#001	EL#104	QTCG*?RD
????????	EIA IA51	EL#002	ETH#L66	R#N7475
ALLIED 1	EIA512 #	EL#002 ?	ETH#L81	R#N756
BATTL 05	EIA512 0	EL#004	FUZZ#82	R#N842
BOYER 40	EIA512 9	EL#007	IND#82	...
C#A951	EIA512 E	EL#008	KING 21	ZA IA51

### 5.2.5 Airborne Velocity Messages

Airborne Velocity Messages contain horizontal velocity information in airspeed and heading form or as East-West and North-South velocity. This information is not discussed in this report. Airborne Velocity Messages also contain vertical rate information. Table 9 shows vertical rate information extracted from the two different formats of Airborne Velocity Messages. Extreme outliers, i.e., vertical rates with magnitude greater than 10,000 feet per minute have been omitted from the tables.

Approximately five percent of Airborne Velocity Messages are reported in airspeed and heading format. These messages were considered reasonable if the heading status bit indicates heading information was available and the vertical rate field was non-zero. The remaining 95 percent of Airborne Velocity Messages are reported in velocity over ground format indicating that they are equipped with navigation instruments capable of providing sufficiently accurate velocity information. These messages were considered reasonable if the East-West and North-South velocity fields were non-zero.

**Table 9. Summary of All Airborne Velocity Messages**

Airspeed and Heading			
Day	Total Reports	Maximum Descend Rate	Maximum Climb Rate
11	56565	-5760	2432
12	55138	-5312	2880
13	32714	-4992	4608
14	54429	-4096	3904
15	51907	-3712	4416
16	31710	-4224	1984
17	31262	-5440	4608

Velocity Over Ground			
Day	Total Reports	Maximum Descend Rate	Maximum Climb Rate
11	2552611	-6656	6848
12	2460576	-6720	5952
13	2558426	-6400	6592
14	2564600	-6464	6336
15	2300757	-7552	7232
16	1440671	-8064	7808
17	1314917	-6656	7488

The velocity over ground format Airborne Velocity messages were tabulated for Version 1 transponder-equipped aircraft and shown in Table 10 below. Note, in general, the maximum descend rate observed per day is smaller in magnitude than those observed in the combined Version 0 and Version 1 table above. This indicates that the vertical rate information reported by Version 0 transponders is noisier and therefore less likely to be useful for future collision avoidance systems. One exception to the general

trend of higher vertical rates being reported by Version 0 equipped aircraft is shown in Table 10, when the maximum descend rate is -7552 fpm, indicating that a Version 1 transponder-equipped aircraft displayed the highest descend rate on 15 April. Two more exceptions occur for two of the seven days (14 April and 16 April), when the maximum climb rate value in the Version 1 table is the same for the combined Version 0 and Version 1 table above, indicating that a Version 1 transponder-equipped aircraft displayed the highest rate of climb for those two days.

**Table 10. Version 1 Airborne Velocity Messages**

Day	V1 AC	Reports	Maximum Descend Rate	Maximum Climb Rate
11	9	31183	-4224	4672
12	7	27856	-5376	4032
13	30	124967	-4800	5888
14	29	121167	-5248	6336
15	34	125182	-7552	6016
16	17	50982	-6400	7808
17	11	30566	-5312	5824

A Version 0 equipped aircraft was initially selected for analysis. The Airborne Position Messages and Airborne Velocity Messages were plotted. The vertical rate data was not of sufficient quality to merit further study. The decision was made to focus entirely on Version 1 transponder messages.

The Version 1 transponder-equipped aircraft with the highest descend rate of 7552 fpm was selected for study. Figure 39 shows the location of the aircraft for a 33 minute time segment beginning with level flight at 33,000 feet followed by a period of descent to landing at Logan Airport. Figure 40 shows the altitude vs. time data for the same time period. The NIC for this aircraft is 7, indicating a HPL (horizontal protection limit) between 0.1 and 0.2 nmi.

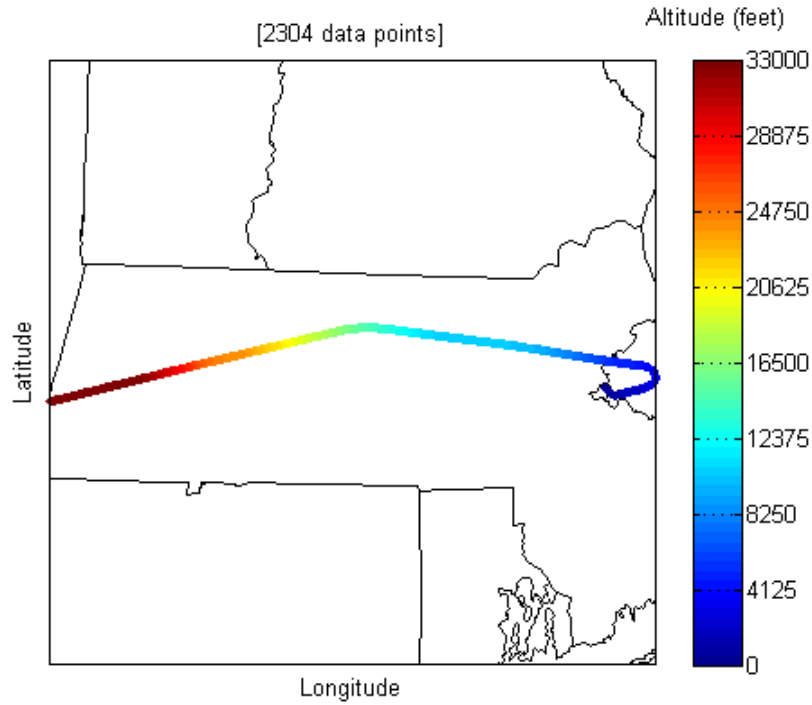

Figure 39. Aircraft location from ES Airborne Position Messages

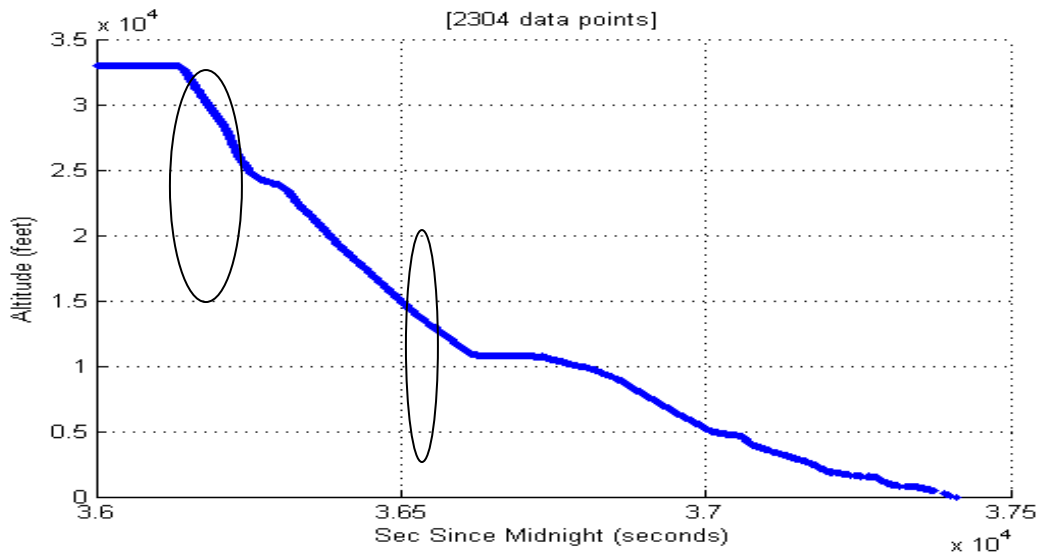

Figure 40. Altitude vs. time from Version 1 ES Airborne Position Messages

The vertical rate data from the velocity over ground format Airborne Velocity Messages for the same aircraft and the same time period are shown in Figure 41. The NAC-v for this aircraft is 2, indicating a Vertical Figure of Merit of 15 feet per second.

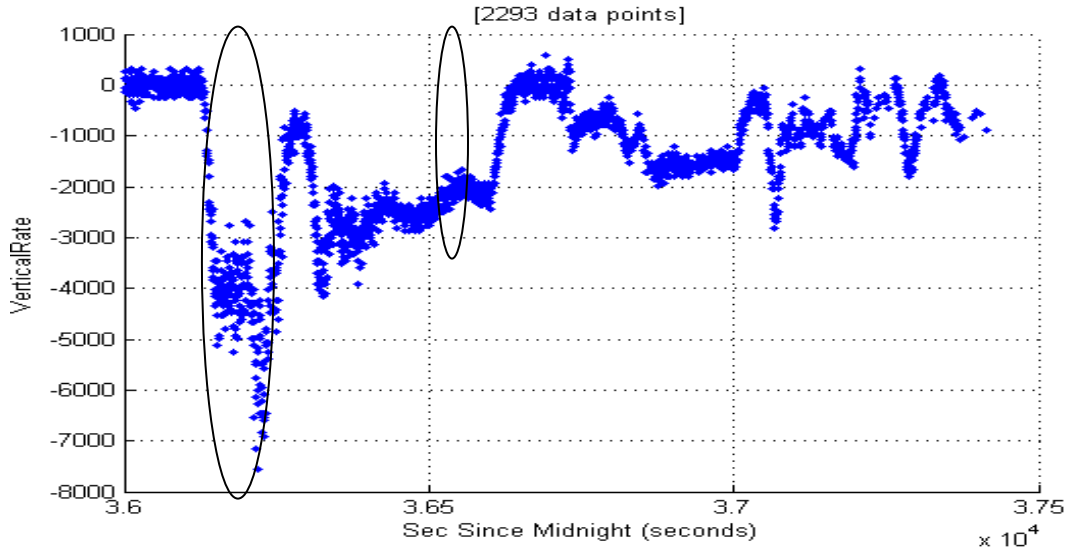

Figure 41. Vertical rate vs. time from Version 1 ES Airborne Velocity Messages

Figure 41 shows that when the aircraft was in level flight (33,000 feet/32,975 feet), the reported vertical rate varied between  $-450$  fpm and  $325$  fpm. Note that prior to the aircraft briefly leveling off (shown in the two circled areas), the reported rate of descent increased before trending towards zero.

A second Version 1 transponder-equipped aircraft was chosen with the highest observed NIC value of 10. Figures 42 and 43 show altitude vs. time from the Airborne Position Messages and reported vertical rate (with NAC-v of 2) vs. time from the velocity over ground format Airborne Velocity Messages.

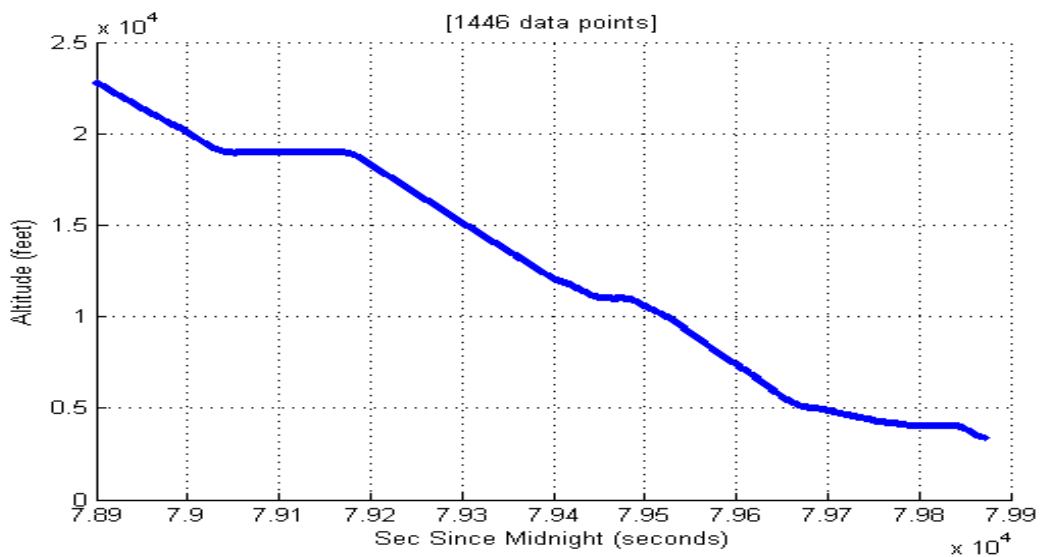

Figure 42. Altitude vs. time from Version 1 ES Airborne Position Messages



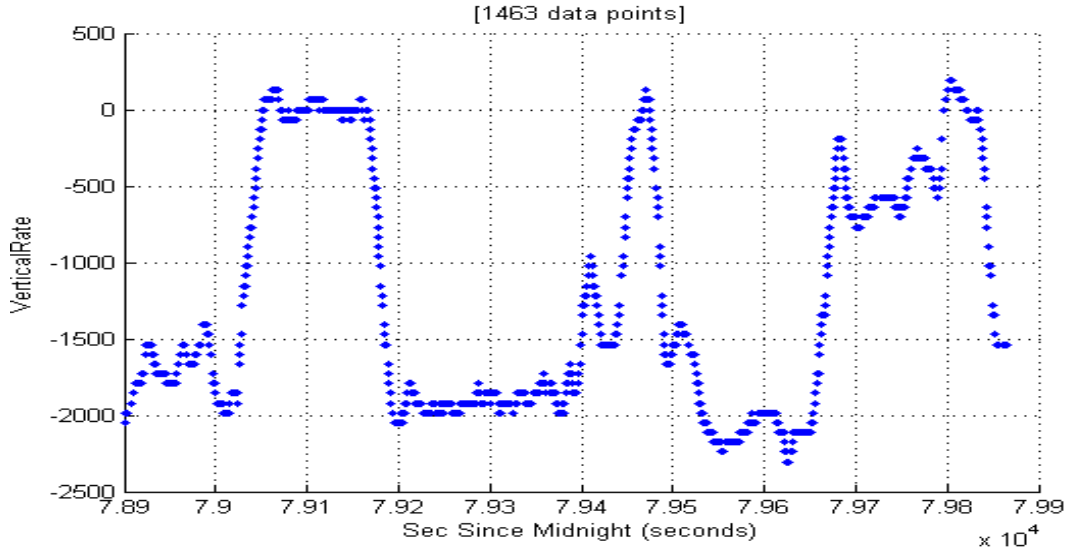

Figure 43. Vertical rate vs. time from Version 1 ES Airborne Velocity Messages

The vertical rate information reported by the Version 1 transponder with high NIC value appears to be less noisy and therefore more likely to be beneficial for future collision avoidance system use. Version 0 ADS-B data is not expected to be beneficial for future collision avoidance systems.

### 5.2.6 Aircraft Operational Status Messages

Aircraft Operational Status messages contain information regarding the precision category information. During the seven-day reporting period, seventy-nine aircraft provided Aircraft Operational Status messages. Table 11 below provides a summary of the Navigation Accuracy Category-position (NAC-p) reported by these aircraft. NAC-p is reported in terms of the Estimated Position Uncertainty (EPU).

Table 11. ES Aircraft Operational Status Messages

NAC-p	Meaning	# Aircraft	Country
0	Unknown accuracy	9	USA, Canada, UK
0,7		3	USA
7	$0.05 \leq \text{EPU} < 0.1$ nautical miles	21	USA
7,8		34	USA
0,7,8		4	USA
8	$30 \leq \text{EPU} < 92.6$ meters	3	France ,USA, United Arab Emirates
9	$10 \leq \text{EPU} < 30$ meters	1	USA
10	$3 \leq \text{EPU} < 10$ meters	4	USA, Canada

Note that often a single aircraft reported different NAC-p values. Eight aircraft reported NAC-p values of eight or higher.

### **5.2.7 Extended Squitter Aircraft Status Messages**

Aircraft Status Messages provide information on possible emergency states experienced by the aircraft. Newer versions of this message (Version 2, corresponding to RTCA DO-260B) provide for inclusion of TCAS Resolution Advisory information. This information would use the same format as the TCAS RA Report discussed in Section 3.1.

No Aircraft Status Messages were observed in the Thales data for the previous reporting period 22–29 November 2009. No Aircraft Status messages were observed in the Thales data for the current one-week in-depth analysis period 11–17 April 2010. Based on a previous study of Extended Squitter messages recorded by a Sensis receiver sited on Katahdin Hill in Lexington [7], we would expect to see some Aircraft Status Reports (previously called Emergency/Priority Status Messages) during this period. This issue was investigated during this reporting period. All extended squitter messages were scanned for the format type code of 28 associated with the Aircraft Status Message. We will continue to scan for these messages in future reports.

### **5.3 Future Work**

Future 1090 MHz Extended Squitter tasks include:

- (1) Work with FAA and EUROCONTROL CASCADE program to determine if transmitted ES position and velocity data is as good as it claims to be.
  - Map quality to specific airlines, airframes, manufacturers, TCAS and transponder versions, etc.
- (2) Check for consistency among airborne position, velocity, heading, airspeed, etc.
  - Correlate Lincoln Mode S radar data and Thales data.
  - Refine reasonableness checks on data fields.
- (3) Show trends in equipage.
- (4) Based on potential improvements to the collision avoidance logic [8], select specific ES messages and data fields for study.
  - Use CASSATT to determine the maximum possible improvement in collision avoidance performance by use of these (perfect quality) ADS-B data fields in the threat logic. (That is, does it make sense to pursue use of these specific data fields?)
  - Determine the actual data quality necessary to achieve meaningful improvement.
  - Monitor the data quality observed in ES transmissions in the Boston airspace to see if it meets the necessary data quality.
- (5) Deploy the Thales 1030/1090 receiver temporarily at airports near TRAMS sites.
  - Provide additional data for use in the Lincoln Laboratory Surveillance Simulation.
  - Arrange to collect concurrent Thales 1030/1090 receiver data, TRAMS data, and TCAS flight test data.
- (6) Investigate using the Thales receiver for airborne measurements.

## 6. SUMMARY

This second report of the Lincoln Laboratory 1030/1090 MHz monitoring covers the period March through June 2010. There are three main areas of study:

- (1) 1030 MHz data related to TCAS air-to-air coordination and other communications,
- (2) 1030 and 1090 MHz data related to TCAS surveillance, and
- (3) 1090 MHz Extended Squitter data, i.e., the Mode S implementation of ADS-B.

Immediately prior to the four-month recording period, the 1030/1090 MHz receiver system was moved from its previous position at the Lincoln Laboratory Flight Facility near Hanscom Field to its current position, 1.2 miles to the east at a higher elevation. This location provides a higher message reception rate and a greater coverage area than the previous location. Significant effort was expended in validating the performance of the receiver in its new location, and this effort is described in detail in the report.

In general, 1030/1090 MHz reception rates were relatively stable over the four-month period and also consistent with the rates shown in the first report. One notable exception occurred during the time of the Icelandic volcano eruption, when flights to and from Europe were curtailed and the decrease in Extended Squitter equipage was immediately noticeable. Similar to the first report, TCAS-generated 1030 MHz and 1090 MHz signals accounted for a majority of the overall 1030 MHz and 1090 MHz signals received. However, in absolute terms, the TCAS contribution to the total 1030/1090 MHz spectrum was quite small. TCAS 1030 MHz Mode S transmissions accounted for 2.4 percent of the total 1030 MHz Mode S time line, and TCAS Mode S 1090 MHz transmissions accounted for 1.8 percent of the total 1090 MHz Mode S time line. Approximately 75 percent of the Mode S aircraft observed were TCAS equipped; and excluding the time around the volcanic eruption, approximately 28 percent of Mode S aircraft were equipped with Extended Squitter.

Key take-away information from the report includes the following:

Automated analysis tools were developed to examine every message transmitted during TCAS air-to-air coordination and to check for data consistency throughout the entire process, both internally within a single aircraft and also between the two aircraft. Error reports that itemize specific errors by aircraft address can be used for follow-up by FAA Certification officials or by Lincoln Laboratory. During this reporting period, no problems were noted in the coordination of maneuvers between aircraft, but a number of anomalies were seen in messages used to report RA information (e.g., RA Reports to Mode S ground sensors, RA Broadcast Interrogations, and coordination replies). In addition, two particular groups of aircraft (one U.S. military, one non-U.S. civil) transmitted coordination interrogations that appeared to be unrelated to an RA event, but rather related to interference with surveillance equipment onboard the aircraft. While no adverse affects were observed in actual air-to-air coordination, we believe the potential for adverse affects and/or safety issues exists. Lincoln will follow up directly with military representatives, and FAA Certification will explore follow-up with the non-U.S. aircraft representatives.

A detailed examination was performed of air-to-air TCAS surveillance messages exchanged between aircraft. This examination pinpointed TCAS re-interrogations in high density areas and identified specific aircraft whose surveillance behavior appeared abnormal. Further analysis is planned to determine the frequency with which these aircraft exhibit unusual behavior, whether they appear to have any characteristics in common (e.g., same TCAS or transponder manufacturer), and possible causes of the behavior.

This four-month period will be used to baseline 1030/1090 MHz activity in the New England area. Future plans call for limited periods of 1030/1090 MHz data recording at various TCAS RA Monitoring System (TRAMS) sites throughout the NAS. The extensive 1030/1090 MHz analysis tools developed to date will allow large amounts of collected data to be examined quickly to determine overall statistics and to locate time periods of particular interest for detailed study. In addition, 1030/1090 MHz recording at other TRAMS sites can supplement the recorded Mode S radar surveillance data being used in the Lincoln Laboratory TCAS surveillance simulation. The first TRAMS site selected for 1030/1090 MHz monitoring is expected to be New York City's JFK International Airport.

## GLOSSARY

ADS-B	Automatic Dependent Surveillance-Broadcast
ARA	Active Resolution Advisory
ATCRBS	Air Traffic Control Radar Beacon System
ES	Extended Squitter
MOPS	Minimum Operational Performance Standards
NAC-p	Navigational Accuracy Category-position
NAS	National Airspace System
NIC	Navigational Integrity Category
NTA	Number of TCAS Aircraft
NUC	Navigational Uncertainty Category
PSR	Primary Surveillance Radar
RA	Resolution Advisory
RAID	Redundant Array of Inexpensive Disks
RAC	Resolution Advisory Complement
SSR	Secondary Surveillance Radar
TA	Traffic Advisory
TCAS	Traffic Alert and Collision Avoidance System
TOPA	TCAS Operational Performance Assessment
TRAMS	TCAS RA Monitoring System
TSO	FAA Technical Standard Order
UPS	Uninterruptible Power Supply
UTC	Coordinated Universal Time
VRC	Vertical Resolution Advisory Complement
WJHTC	FAA William J. Hughes Technical Center

This page intentionally left blank.

## REFERENCES

1. A. Drumm, G. Harris, B. Chludzinski, W. Harman, and A. Panken, "Lincoln Laboratory 1030/1090 MHz Monitoring," Project Report ATC-367, MIT Lincoln Laboratory, 28 July 2010.
2. P. Form, J. Gottstein, and R. Mallwitz, "Detected Deficiencies in ACAS RA Related Transmissions," ICAO Aeronautical Surveillance Panel, WP ASP 01-12, 27 October 2006.
3. B. Chludzinski, "Quick-Look Analysis of Mode S Messages Recorded Using Sensis and Thales 1090 MHz Receivers for the TCAS Program Office," MIT Lincoln Laboratory, 21 January 2010.
4. RTCA DO-260B, "Minimum Operational Performance Standards for 1090 MHz Extended Squitter Automatic Dependent Surveillance-Broadcast (ADS-B) and Traffic Information Services – Broadcast (TIS-B)," 2 December 2009.
5. FAA TSO-C166b, "Extended Squitter Automatic Dependent Surveillance – Broadcast (ADS-B) and Traffic Information Service-Broadcast (TIS-B) Equipment Operating on the Radio Frequency of 1090 MHz," 2 December 2009.
6. RTCA DO-181D, "Minimum Operational Performance Standards for Air Traffic Control Radar Beacon System / Mode Select (ATCRBS/Mode S) Airborne Equipment," 2 October 2008.
7. B. Chludzinski, "Lincoln Laboratory Initial Evaluation of 1090 MHz Extended Squitter Data," Project Report ATC-362, MIT Lincoln Laboratory, 11 March 2010.
8. D. Spencer, "Some Potential Improvements to the TCAS II Collision Avoidance System," MIT Lincoln Laboratory, 29 July 2009.

This page intentionally left blank.



## **APPENDIX A**

### **ADDITIONAL ANALYSES TO CHARACTERIZE THE 1030/1090 MHz ENVIRONMENT**

This appendix describes four analyses for providing additional insight into the 1030/1090 MHz environment. The analyses are:

- (1) Aircraft counts by type (all aircraft, ATCRBS, Mode S, and ADS-B) over a number of days, preferably a minimum of seven days.
- (2) Aircraft counts as a function of range from the receiver.
- (3) Reception rate (by aircraft type) over a 24-hour period.
- (4) Reception rate (by aircraft type) versus received power level.

The first two analyses were performed using data from the 1030/1090 MHz receiver in combination with radar data from the FAA Mode S sensor located at Lincoln Laboratory. At another location, TRAMS data would be used to provide the Mode S radar data.

The second two analyses are similar to, but more detailed than, analyses presented in Section 4 of this report. In particular, Figure A-3 is an expansion of Figure 19, and Figure A-4 is an expansion of Figure 25. Note that the day chosen for Figure A-3, 26 June 2010, is not the same day chosen for Figure 25, 16 June 2010. The time period chosen for the four analyses in this appendix was based on availability of Mode S radar data, thus limiting the time period selection.

#### **A.1 AIRCRAFT COUNTS BY TYPE**

Figure A-1 shows the number of aircraft vs. time for an 8-day period, based on surveillance by the Lincoln Laboratory Mode S radar. This is a cumulative plot, in which the upper curve includes all transponder-equipped aircraft, and the middle curve includes all Mode S-equipped aircraft. Therefore, the separation between the upper curve and the middle curve shows the number of ATCRBS aircraft (shaded green in the figure). The points are spaced by one hour, and each point is the average count during that hour. The surveillance range is 60 NM.

Some day-to-day differences come to light in this plot. The number of aircraft was considerably reduced on Wednesday and Thursday, but increased abruptly on Friday. On the other hand, the number of Mode S aircraft was more constant from day to day. From looking at this data, one would consider weather to be a likely explanation for the day-to-day differences. With that in mind, we researched the weather and found that Wednesday and Thursday were bad weather days followed by clear weather on Friday. It is likely that the poor weather on Wednesday and Thursday caused the ATCRBS aircraft to be fewer on those days, while the Mode S aircraft, largely scheduled airliners, remained about the same from day to day.

The lowest curve shows the count of ADS-B-equipped aircraft. The ADS-B count was based on omnidirectional receptions as well as radar data. The method of counting consisted of examining each Mode S aircraft in the radar data and then comparing its address with the list of addresses derived from omnidirectional receptions of ADS-B Position Squitters. The ADS-B counts in Figure A-1 indicate that the numbers were about the same each day. About 15 percent of the Mode S aircraft were ADS-B equipped.

Note that in Section 5.2.1, the percentage of Mode S aircraft that were ADS-B equipped was measured in a different way, using just omnidirectional receptions. Figure 35 shows that about 23 percent of Mode S aircraft transmitted Position Squitters. That result is higher than the percentage shown here, probably because of the difference in range. In the radar-based data shown in Figure A-1, the ranges are limited to 60 NM, whereas Figure 35 includes all ranges within line-of-sight. Because of earth curvature, aircraft at

long range are consistently at high altitudes, so they are likely to be mainly airliners. Furthermore, the long-range, high-altitude aircraft received in this Lexington location include many international flights. As shown in Section 5.2.1, Figures 33 and 34, European aircraft generally have high percentages of ADS-B equipage.

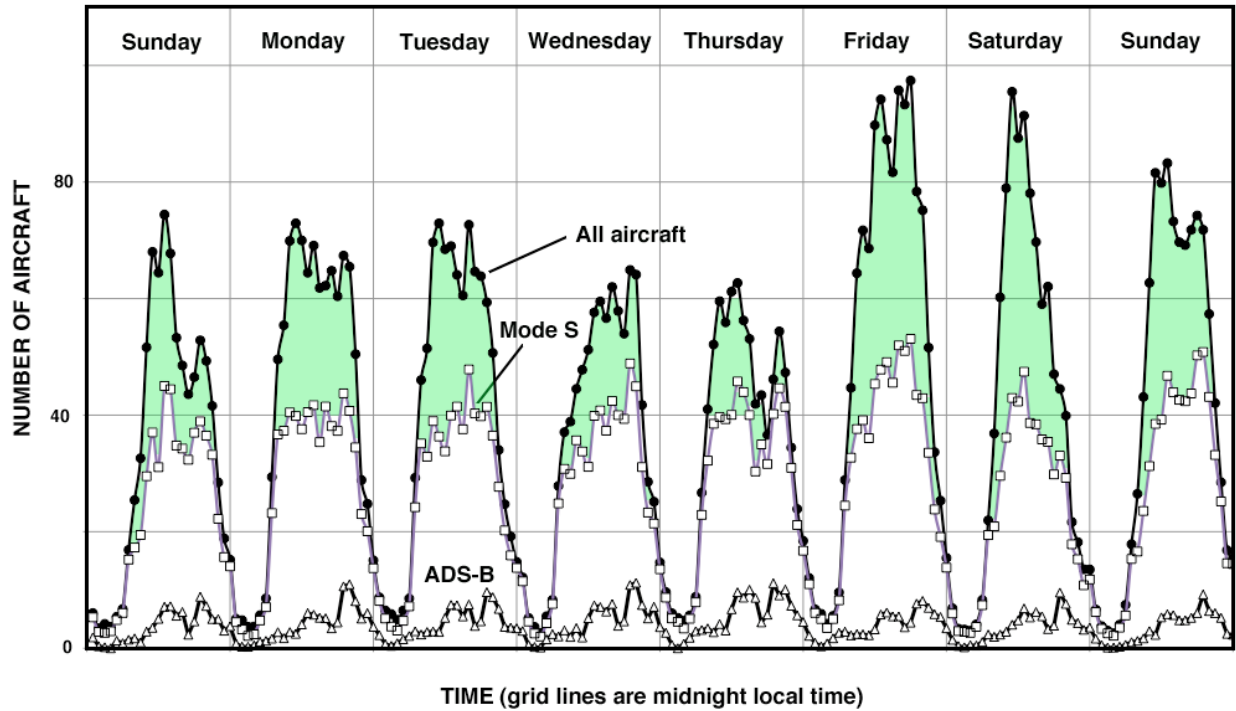

Figure A-1. Aircraft counts over an 8-day period  
20 to 27 June 2010

Figure A-2 shows the aircraft counts as a function of range. This is a cumulative count in which each point represents the number of aircraft at that range or less. It is also cumulative in the same sense as Figure A-1 (the upper curve represents all aircraft, and the other two curves are subsets). The curves are linear over most of the range extent, which means that there is a higher density of aircraft (aircraft per square NM) near the radar. That behavior is familiar for measurements centered at a major city, having been seen in a number of measurements over many years.

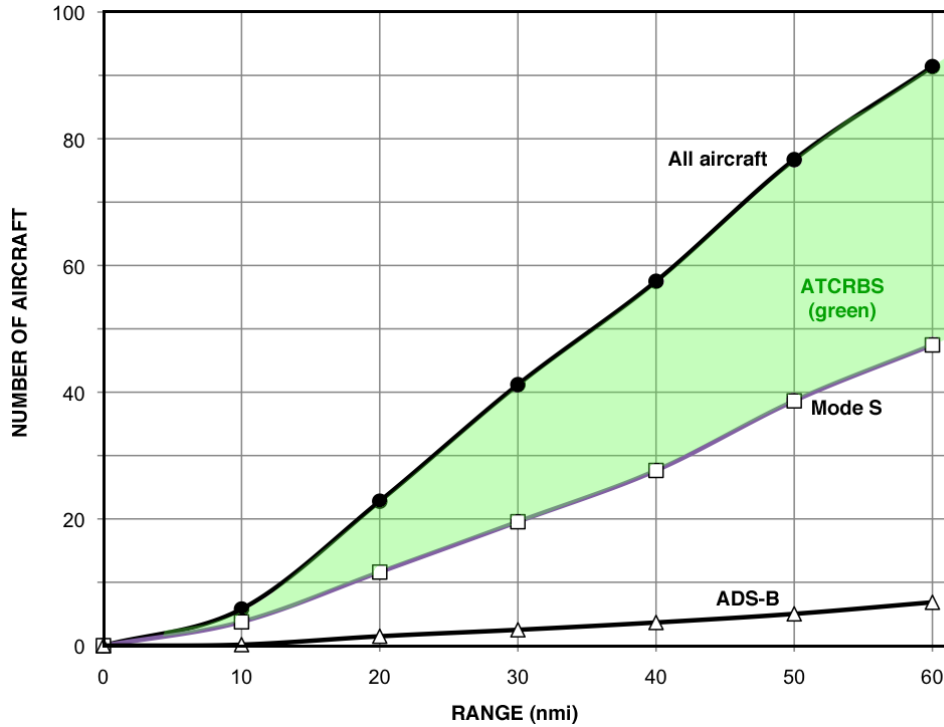

Figure A-2. Number of aircraft vs. range (cumulative plot)  
26 June 2010, 2:00–3:00 PM local time

## A.2 MESSAGE RECEPTION RATES

Figure A-3 focuses attention on one full day, showing the omni-directional reception rate vs. time. The 1030 MHz rates in the upper plot apply to a receiver MTL value of  $-74$  dBm before the antenna; the 1090 MHz rates in the lower plot apply to a receiver MTL value of  $-84$  dBm before the antenna. In both cases, the antenna gain (+7 dB) of the omni-directional antenna has been subtracted from the measured power values so that the received power levels represent the signal strength arriving at the antenna. In other words, this is the power that would be received by a 0 dB antenna.

The 1090 MHz rates shown here (the lower plot) can be compared with the numbers of aircraft in Figure A-1. The curve shapes are essentially the same (number of aircraft vs. time and 1090 reception rate vs. time), which seems reasonable. Looking at the 1030 MHz rates here, we see that the Mode S reception rate did not drop to around zero at night, which is different from the number of aircraft curves in Figure A-1. That behavior seems reasonable too, because the nearby Mode S radar continues to transmit interrogations throughout the day and night.

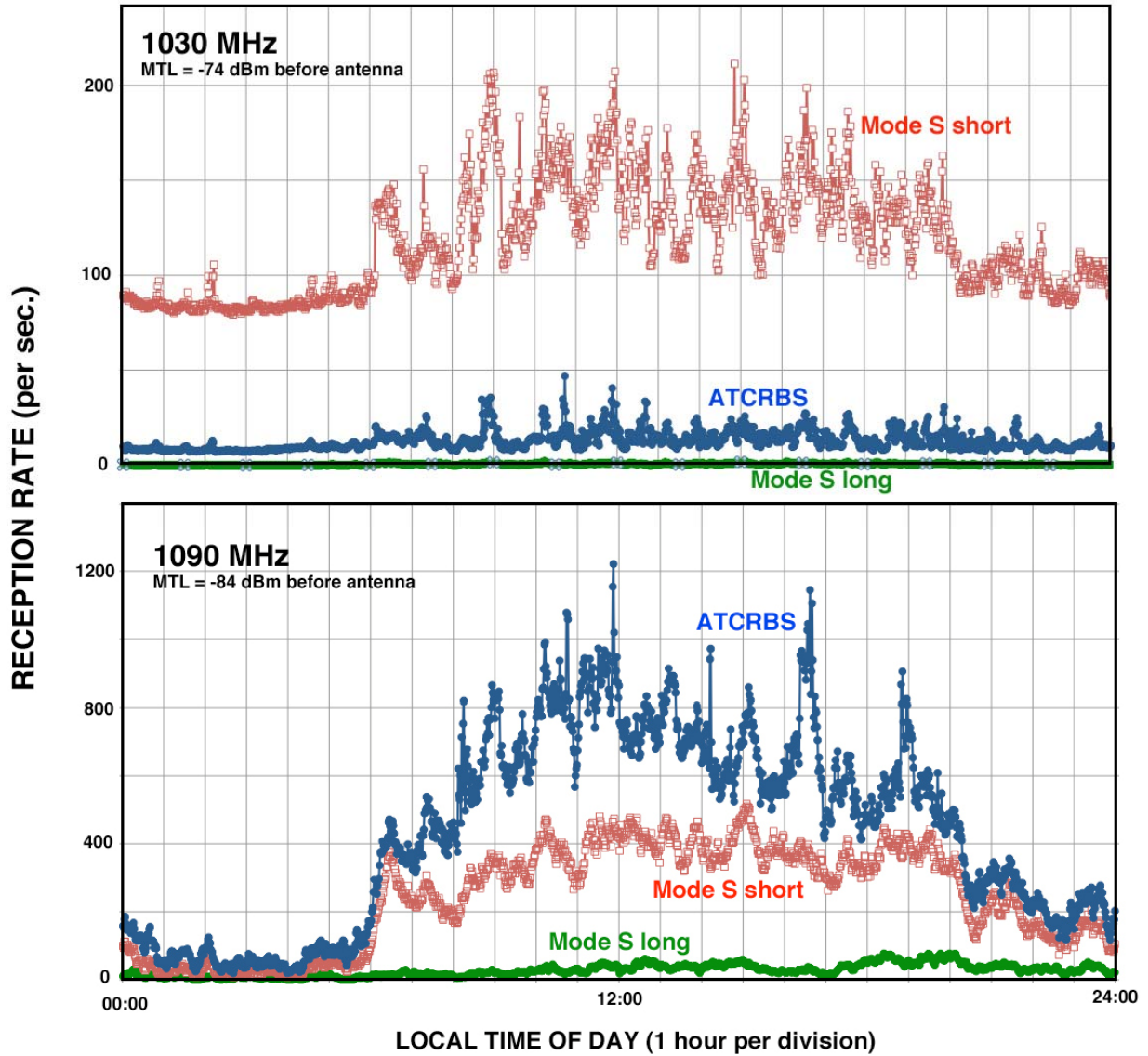

Figure A-3. Receptions over a 24-hour period  
26 June 2010

Figure A-4 presents the omni-directional reception rates in the standard form giving reception rate vs. received power level. This is a cumulative format, in which each point is the total rate of receptions at that power level and lower.

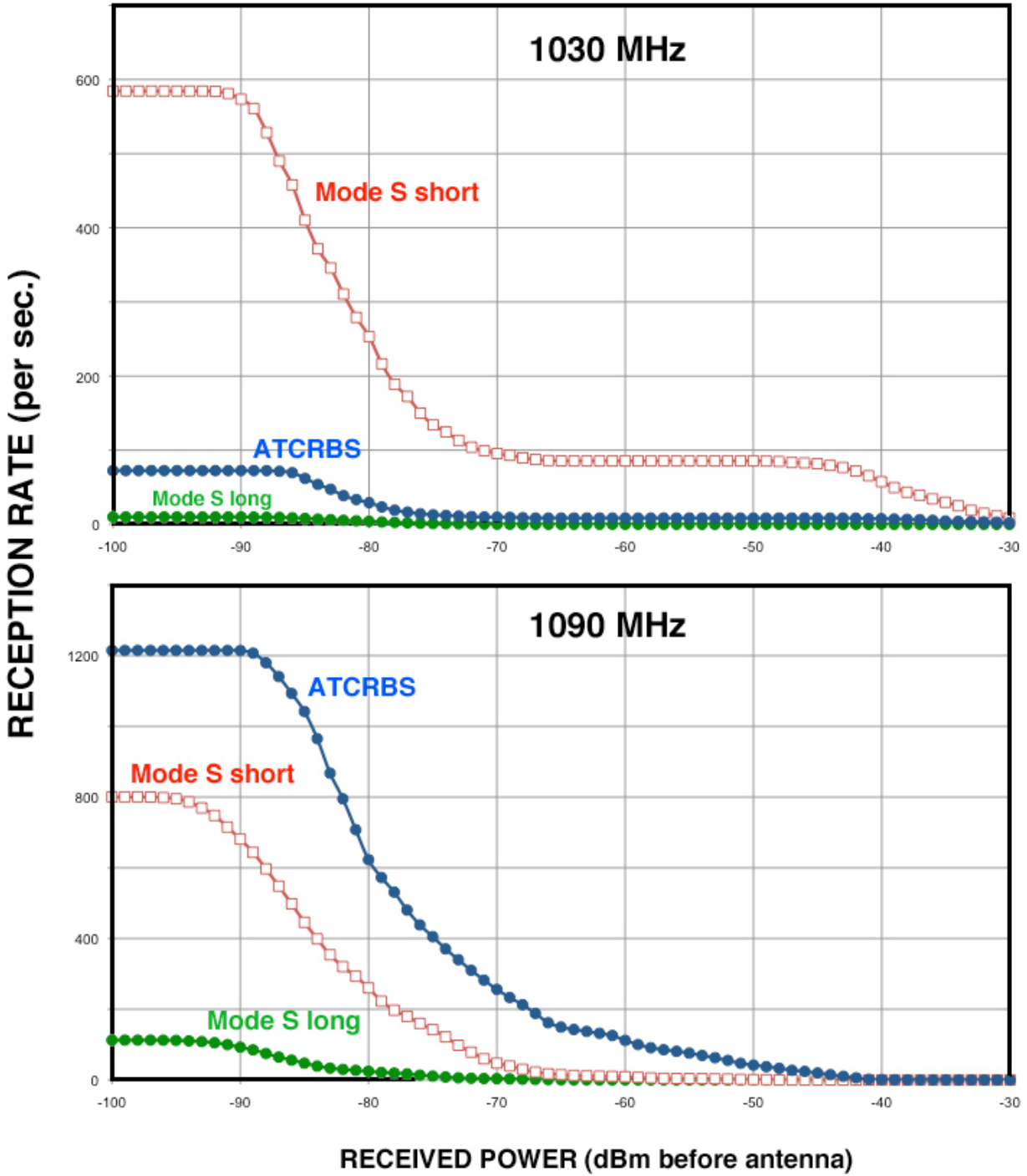

Figure A-4. Reception rate vs. power  
26 June 2020, 11:30–11:31 AM local time

This page intentionally left blank.

## APPENDIX B

### A CHECKLIST FOR 1030/1090 MHZ ANALYSIS AT REMOTE SITES

This appendix gives a checklist of analyses to be performed at remote sites in order to compare the 1030/1090 MHz environment at those sites with the New England baseline environment described in this report. The checklist is made up of figure numbers, table numbers, and/or descriptions from the body of this report and from Appendix A, as well as a description of one additional analysis to determine the number of on-the-ground aircraft operating with their TCAS units turned on.

It is desirable that data recording be performed for a minimum seven days, if possible, in order to capture both hourly and daily fluctuations in the environment, and also to a lesser extent, variation in weather conditions. As noted below, some plots would represent activity over the entire monitoring period; other plots would represent a more limited time period (e.g., an hour), selected on the basis of particular criteria, e.g., maximum overall message volume, suspected anomalies.

#### Overall 1030/1090 MHz Receptions

1. TCAS Contribution to the 1030/1090 MHz spectrum. Example: Table 5.
2. Message receptions vs. time. Examples are Figure 19 (time period = 1 month), Figure A-3 (time period = 24 hours), and Figure 22 (time period = 2 hours). The optimum representation would be as shown in A-3 (depicting the various message types (all, ATCRBS, Mode S short, Mode S long)) with one figure for each day of recording.
3. Message reception rate vs. received power. Example: Figure 20.
4. Message reception rate vs. cumulative received power. Examples: Figures 21 and A-4.
5. Message reception rate for Mode S Format types. Example: Figure 23.
6. Aircraft counts vs. time. Example: Figure A-1. This would require TRAMS radar data.
7. Number of aircraft vs. range. Example: Figure A-2. This would require TRAMS radar data.

#### 1030 MHz Analysis

8. Coordination, message bit errors. Example: Table 1.
9. Coordination, event analysis. Example: Table 2.
10. TCAS Broadcast Interrogations. Example: Text, Section 3.2.1.

#### 1090 MHz Extended Squitter Analysis

11. Counts of ES-transmitting aircraft. Examples: Figures 30 and 31.
12. ES information. Example: Figure 32.
13. ES availability by country. Examples: Figures 33 and 34.
14. Aircraft transmitting ES registers. Example: Figure 35.
15. Locations of Airborne Position Messages received. Examples: Figures 36 and 37.
16. Surface Position Messages. Example: Figure 38.
17. Aircraft Identification and Category Messages. Example: Table 7.
18. Airborne Velocity Messages. Example: Table 9.
19. Aircraft Operational Status Messages. Example: Table 11.
20. ES Aircraft Status Messages. Example: Text, Section 5.2.7.

## **On-the-Ground TCAS**

### 21. Number of on-the-ground operating TCAS units vs. time.

Steps include:

- (1) Determine the addresses of on-the-ground Mode S aircraft by examining the following transmissions:
  - (a) DF11 (acquisition squitter) or DF17 (extended squitter), specifically the Transponder Capability (CA) field, bits 6–8. CA = 4 indicates on the ground. If the CA field is inconclusive (CA = 6 or 7), then examine any or all of the following transmissions.
  - (b) DF0 (short air-to-air surveillance), specifically the Vertical Status (VS) field, bit 6. VS = 1 indicates on the ground.
  - (c) DF4, 5, 20, or 21 (air-to-ground surveillance), specifically the Flight Status (FS) field, bits 6–8. FS = 1 or 3 indicates on the ground.
- (2) Determine the addresses of operational TCAS units by examining UF16 TCAS Broadcast Interrogation Messages, defined by U-Definition Subfield (UDS) = 32 hex = 50 decimal. The 24-bit Mode S address is contained in bits 65–88.
- (3) Plot the number of on-the-ground operating TCAS units as a function of time. In addition, position information for the on-the-ground TCAS may be obtained for some of the aircraft from ADS-B Position Squitters and/or from associated Mode S radar tracks.