

**Project Report
ATC-235**

**GPS-Squitter Automatic Dependent
Surveillance Broadcast: Flight Testing
in the Gulf of Mexico**

**R. E. Boisvert
M. L. Burrows
S. R. Bussolari
G. H. Knittel
M. R. Owen
K. W. Saunders**

13 October 1995

Lincoln Laboratory
MASSACHUSETTS INSTITUTE OF TECHNOLOGY
LEXINGTON, MASSACHUSETTS

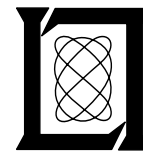

Prepared for the Federal Aviation Administration,
Washington, D.C. 20591

This document is available to the public through
the National Technical Information Service,
Springfield, VA 22161

This document is disseminated under the sponsorship of the Department of Transportation in the interest of information exchange. The United States Government assumes no liability for its contents or use thereof.

1. Report No. ATC-235	2. Government Accession No.	3. Recipient's Catalog No.	
4. Title and Subtitle GPS-Squitter Automatic Dependent Surveillance Broadcast: Flight Testing in the Gulf of Mexico		5. Report Date 13 October 1995	6. Performing Organization Code
7. Author(s) R. E. Boisvert, M.L. Burrows, S.R. Bussolari, G.H. Knittel, M.R. Owen, and K.W. Saunders		8. Performing Organization Report No. ATC-235	
9. Performing Organization Name and Address Lincoln Laboratory, MIT 244 Wood Street Lexington, MA 02173-9108		10. Work Unit No. (TRAIS)	11. Contract or Grant No. DTFA01-93-Z-02012
12. Sponsoring Agency Name and Address Department of Transportation Federal Aviation Administration Systems Research and Development Service Washington, DC 20591		13. Type of Report and Period Covered	
15. Supplementary Notes This report is based on studies performed at Lincoln Laboratory, a center for research operated by Massachusetts Institute of Technology under Air Force Contract F19628-95-C-0002.		14. Sponsoring Agency Code	
16. Abstract <p style="text-align: center;">During November – December 1994, MIT Lincoln Laboratory conducted a field evaluation of the air surveillance capabilities of GPS-Squitter in the Gulf of Mexico. Three squitter ground stations were located in the vicinity of Morgan City, Louisiana, for this evaluation: two were located on offshore oil platforms, and the third was located at an onshore heliport. Surveillance coverage tests were flown over the Gulf with three test aircraft—two helicopters and one Cessna 421 fixed-wing aircraft. The helicopters flew at altitudes ranging from 100 to 2000 feet above sea level and the Cessna flew at 7500 and 20,000 feet. Extended squitter messages broadcast by each of the test aircraft provided aircraft position and identification.</p> <p>This report documents results of these tests and compares measured coverage to predicted coverage from the ground stations. Based on the good agreement between predicted and measured performance, a description of a possible operational system is included that would provide surveillance of the entire Gulf region serviced by oil platform helicopters. The report concludes that GPS-Squitter is a near-term option for providing accurate, real-time surveillance of aircraft operating in the offshore airspace in the Gulf of Mexico.</p>			
17. Key Words Automatic Dependent Surveillance Mode S Gulf of Mexico GPS GPS-Squitter aircraft surveillance helicopter Mode S transponder		18. Distribution Statement This document is available to the public through the National Technical Information Service, Springfield, VA 22161.	
19. Security Classif. (of this report) Unclassified	20. Security Classif. (of this page) Unclassified	21. No. of Pages 92	22. Price

EXECUTIVE SUMMARY

GPS-Squitter is a technology for aircraft surveillance in which aircraft broadcast their GPS-determined positions to all listeners via the Mode S data link. It can be used to provide aircraft traffic displays, on the ground for controllers and in the cockpit for pilots. It is compatible with existing ground-based beacon interrogator radars and is an evolutionary way to move from ground-radar surveillance to Automatic Dependent Surveillance.

During a July 1994 meeting, the FAA requested that MIT Lincoln Laboratory conduct a demonstration of GPS-Squitter in the Gulf of Mexico. Shortly thereafter, in November-December 1994, a field evaluation of GPS-Squitter for air surveillance was held in the Gulf. Objectives of this evaluation were to determine the suitability of GPS-Squitter for air surveillance in general, and more specifically for air surveillance of helicopters servicing oil platforms in the Gulf of Mexico.

The offshore region of the Gulf of Mexico, encompassing approximately 1800 oil platforms with helipads, is a busy flight zone with 600 helicopters conducting an average of 5000 flights per day. At present, there is no radar coverage for these flights because they are too low to be covered by shore radar. There is a need for accurate real-time surveillance of the aircraft for both increased safety and efficiency reasons.

For the evaluation, three squitter ground stations were located in the vicinity of Morgan City, Louisiana; one at an onshore Petroleum Helicopters Inc. (PHI) heliport and two on offshore oil platforms. Three aircraft were equipped with avionics to squitter, or radiate semi-regularly in time, their GPS positions and other key flight data; two of these were helicopters and one was a Cessna 421 fixed-wing aircraft. Squitter data received by the ground stations were sent to a central control computer via a satcom link, a microwave link, and a direct wire link. The computer correlated the data and transmitted it to a local display at the PHI heliport and to remote displays in the Houston ARTCC and the New Orleans TRACON.

Many tests of coverage were flown, for altitudes varying from 100 feet above sea level to 20,000 feet. Predictions of coverage from each ground station were prepared in advance and used to evaluate measurements. Coverage was generally excellent within ground station line of sight and was consistent with predicted performance. The two ground stations on the oil platforms, which used commercial DME antennas at heights of 160 feet, had signal-to-noise-limited ranges of 100 nmi.

Several tests were run to determine the effect of anomalous propagation on GPS-Squitter performance. No measurable effects were found during the observation period. Other studies and data suggest that anomalous propagation should have little or no effect on GPS-Squitter performance.

Several demonstrations of system performance were held during December 1994 for visitors from the FAA, oil companies, helicopter and communications companies, and from Great Britain. The system performed well with only rare down time for communications link problems. It was concluded that GPS-Squitter technology is viable for air surveillance and is well suited for helicopter surveillance in the Gulf of Mexico.

ACKNOWLEDGMENTS

The authors wish to express appreciation to the Federal Aviation Administration sponsors and program managers for supporting the Gulf of Mexico field evaluation of GPS-Squitter technology.

Ron Jones, AND-310

Carmine Primeggia, ASD-110

Karen Burcham, AND-310

Also, the authors would like to thank the following organizations for their support, which significantly contributed to a successful evaluation.

FAA Southwest Region (ASW-200, ASW-400, ASW-500)

FAA Vertical Flight/GA Program Office AND-610

FAA Air Traffic Procedures/GPS Office ATP-20

FAA Houston ARTCC

FAA New Orleans TRACON

Helicopter Safety Advisory Conference

Petroleum Helicopters, Inc.

PetroCom

Shell Oil Company

Norcen Explorer

Daley Tower Service

NORAD

In addition, we are indebted to our colleagues: Jonathan Bernays, who supervised the avionics equipment and its operation; Bill Harman, who estimated coverage of an operational system; and Walter Brown, who was the Lincoln Laboratory interface with many of the FAA groups listed above. We are also grateful to the many members of the MIT Lincoln Laboratory Flight Facility, Group 42, and Group 41 who worked on all aspects of this endeavor.

TABLE OF CONTENTS

Executive Summary	iii
Acknowledgments	v
List of Illustrations	ix
List of Tables	xiii
1. INTRODUCTION	1
1.1 Background	1
1.2 GPS-Squitter	2
1.3 Report Overview	3
2. TEST OBJECTIVES	5
3. TEST CONFIGURATION	7
3.1 Test Aircraft	7
3.2 Ground Equipment	8
3.3 Communications Performance Issues	22
4. PREDICTED COVERAGE	27
5. FLIGHT TEST RESULTS	33
5.1 Wiggins Bell 206 Helicopter	33
5.2 PHI Bell 206 Helicopter	48
5.3 Cessna 421 Fixed-Wing Airplane	48
5.4 Comparison of Predicted and Measured Performance	59
6. POSSIBLE OPERATIONAL SYSTEM	63
7. SUMMARY	67
APPENDIX A. PROPAGATION TESTING	69
REFERENCES	77

LIST OF ILLUSTRATIONS

Figure No.		Page
1-1	Information contained within the three types of extended squitter messages.	2
1-2	Surveillance applications of GPS-Squitter include: air-ground surveillance, TCAS (Traffic Alert and Collision Avoidance System), CDTI (Cockpit Display of Traffic Information), and surface surveillance.	3
3-1	Overview of avionics and ground equipment used in the Gulf of Mexico.	7
3-2	Aircraft used in the Gulf of Mexico testing (a) Wiggins Bell 206 helicopter, (b) PHI Bell 206 helicopter, and (c) Cessna 421 aircraft.	9
3-3	Configuration of the test aircraft avionics.	11
3-4	Ground Interrogator/Receiver Units (GIRUs) with antenna configurations used in the Gulf of Mexico: (a) directional antenna used at the PHI heliport, and (b) omnidirectional-in-azimuth antenna used on the oil platforms.	13
3-5	Ground station block diagram.	15
3-6	Ground station equipment rack including GIRU processor and Sun workstation.	17
3-7	Communication link from the PHI ground station to the Central Control Computer.	19
3-8	Communication link from the EI 100 ground station to the Central Control Computer.	19
3-9	Communication link from the SMI 268 ground station to the Central Control Computer.	21
3-10	Communications from the Central Control Computer to the traffic displays.	21
3-11	Traffic display example showing test targets, VOR radials, ground station locations, Gulf coastline, and major roads.	23
4-1	Ground station link margin for an aircraft at 2000-ft altitude.	29
4-2	Ground station link margin for an aircraft at 300-ft altitude.	30
4-3	Ground station link margin for an aircraft at 20,000-ft altitude.	30
5-1	Transponder antenna mounted on the underside of the Wiggins Bell 206 helicopter.	35
5-2	Antenna pattern for the Wiggins Bell 206 transponder antenna.	37
5-3a-b	GPS-Squitter surveillance of the Wiggins Bell 206, during a flight to SMI 268 at 100-ft altitude, from the ground station at (a) PHI and (b) SMI 268.	38
5-3c	GPS-Squitter surveillance of the Wiggins Bell 206, during a flight to SMI 268 at 100-ft altitude, from the ground station at EI 100.	39

Figure No.		Page
5-3d	GPS-Squitter surveillance of the Wiggins Bell 206, during a flight to SMI 268 at 100-ft altitude, from the three ground stations combined.	40
5-4a-b	GPS-Squitter surveillance of the Wiggins Bell 206, during a flight to EI 100 at 100-ft altitude, from the ground station at (a) PHI and (b) SMI 268.	43
5-4c	GPS-Squitter surveillance of the Wiggins Bell 206, during a flight to EI 100 at 100-ft altitude, from the ground station at EI 100.	44
5-4d	GPS-Squitter surveillance of the Wiggins Bell 206, during a flight to EI 100 at 100-ft altitude, from the three ground stations combined.	45
5-5	Combined GPS-Squitter surveillance of the Wiggins Bell 206 during flights to SMI 268 and EI 100 at 300-ft altitude.	46
5-6	Combined GPS-Squitter surveillance of the Wiggins Bell 206 during a flight to EI 100 at 2000-ft altitude.	47
5-7	Combined GPS-Squitter surveillance of the PHI Bell 206.	49
5-8a	GPS-Squitter surveillance of the Cessna 421, during a long range flight at 20,000-ft altitude, from the ground station at PHI.	50
5-8b	GPS-Squitter surveillance of the Cessna 421, during a long range flight at 20,000-ft altitude, from the ground station at SMI 268.	51
5-8c	GPS-Squitter surveillance of the Cessna 421, during a long range flight at 20,000-ft altitude, from the ground station at EI 100.	52
5-8d	GPS-Squitter surveillance of the Cessna 421, during a long range flight at 20,000-ft altitude, from the three ground stations combined.	53
5-9a	GPS-Squitter surveillance of the Cessna 421, during a long range flight at 7500-ft altitude, from the ground station at PHI.	55
5-9b	GPS-Squitter surveillance of the Cessna 421, during a long range flight at 7500-ft altitude, from the ground station at SMI 268.	56
5-9c	GPS-Squitter surveillance of the Cessna 421, during a long range flight at 7500-ft altitude, from the ground station at EI 100.	57
5-9d	GPS-Squitter surveillance of the Cessna 421, during a long range flight at 7500-ft altitude, from the three ground stations combined.	58
5-10	Combined GPS-Squitter surveillance of the Cessna 421 during flights along IFR routes at 7500-ft altitude.	60
6-1	Predicted coverage of an offshore region operational system having 10 ground stations on shore towers and 13 ground stations on oil platforms, for aircraft at 300-ft altitude.	64
6-2	Equipment for an offshore region operational system providing both ADS-B surveillance and two-way data link.	65

Figure No.		Page
A-1	Flight path taken by Wiggins Bell 206 helicopter during propagation testing.	70
A-2	The cumulative missed squitter count for the ground station at SMI 268 during the return leg of the daytime flight that used normal system sensitivity.	71
A-3	The cumulative missed squitter count for the PHI ground station during the same return flight leg as Figure A-2.	72
A-4	The cumulative missed squitter count for the SMI 268 ground station during the return flight leg of the daytime flight in which the system sensitivity was reduced by 6 dB.	72
A-5	The cumulative missed squitter count for the PHI ground station during the same return flight leg as Figure A-4.	73

LIST OF TABLES

Table No.		Page
4-1	Link Budget Items	28
4-2	Predicted Ground Station Surveillance Range with a 4 dB Link Margin	31
5-1	Surveillance During Cessna 421 Flight at 20,000-ft Altitude	54
5-2	Surveillance During Cessna 421 Flight at 7500-ft Altitude	59
5-3	Estimated and Measured Maximum Range from PHI Ground Station	61
5-4	Estimated and Measured Maximum Range from Platform Ground Stations	61

1. INTRODUCTION

1.1 BACKGROUND

The offshore region of the Gulf of Mexico from Texas to the Florida panhandle has been the focus of intense petroleum exploration and production activity. Approximately 1800 oil platforms with helipads are located in these waters. At any given time, up to 10,000 men and women are located on the platforms. The safe and efficient transport of workers and materiel to and from the oil platforms is essential to the commercial viability of the Gulf petroleum industry. Much of this transportation is provided by the 600 helicopters that operate in this region. On average, 5000 individual helicopter flights are made per day with about 3 million passengers carried annually.

At present, there is no FAA-provided radar surveillance of the offshore airspace in which the helicopters operate. Most of the flights are conducted under Visual Flight Rules (VFR) in which safe traffic separation is provided by the individual pilots who "see and avoid" other aircraft. Flight following for the VFR helicopters is provided by the individual helicopter companies by means of periodic verbal position reports radioed by the pilots on VHF voice frequencies. Due to frequency congestion and pilot workload, these position reports can be spaced as much as 30 minutes apart. At flight speeds of approximately 100 knots, a helicopter may have traveled as much as 50 nmi between consecutive position reports. This presents a significant problem should the helicopter require emergency services, including search and rescue.

When weather conditions limit visibility, the helicopters must operate under Instrument Flight Rules (IFR) and receive verbal route clearances from FAA Air Traffic Controllers (ATC) via VHF radio. Because ATC does not have radar surveillance of the airspace, the flight operations are conducted using "non-radar procedures". The helicopters are released by ATC at a specific time to fly routes that have been designated for IFR operations in the offshore airspace. An IFR clearance for a helicopter would consist of a departure time, the specific VOR (VHF Omnidirectional Range) radial to follow, the distance along that route, and a specific altitude. Upon reaching the defined point in space, the helicopter would leave the route and descend to a particular altitude where it is anticipated that the visibility would support continued flight to the destination under VFR. If the visibility does not support VFR at that point, the helicopter must climb and return to the IFR route structure and proceed to an alternate destination, perhaps back to shore. During large portions of the IFR flight, particularly during the descent, VHF radio communications may be lost due to line of sight limitations of the Remote Communications Outlets (RCO) used by ATC. This, coupled with the lack of radar surveillance, requires that only a single helicopter may use a particular IFR route at a time, resulting in a severe limitation on capacity in the Gulf offshore airspace.

There is a need for accurate, real-time surveillance of aircraft operating in the offshore airspace of the Gulf of Mexico. This surveillance must be capable of meeting operational requirements of the aircraft operators as well as ATC. It must have sufficient capacity to handle the large number of aircraft in the airspace and sufficient coverage to locate aircraft flying at very low altitudes. The system must meet the cost, weight, power, size, and reliability constraints imposed by the aircraft and the environment in which they operate.

1.2 GPS-SQUITTER

The International Civil Aviation Organization (ICAO) has defined a concept for communications, navigation, and surveillance for the next century known as the Future Air Navigation System (FANS). A cornerstone of the FANS is reliance on the use of satellite-based navigation systems such as the Global Positioning System (GPS). Another application of the FANS is surveillance based on the data link transmission of aircraft-derived position known as Automatic Dependent Surveillance (ADS).

One form of ADS is the spontaneous, omnidirectional broadcast of position by aircraft, known as ADS-Broadcast (ADS-B). The use of broadcast makes it possible for one ADS transmission to simultaneously serve the surveillance needs of multiple ground ATC and airborne collision avoidance applications.

GPS-Squitter [1-3] is a system concept that merges the capabilities of ADS-B and the Mode S beacon radar [4] via the semi-regular transmission of 112-bit Mode S replies known as extended squitters (Figure 1-1). The result is an integrated concept for seamless surveillance that permits equipped aircraft to participate in ADS-B or radar beacon ground environments. GPS-Squitter is a natural way to transition the National Airspace System (NAS) surveillance from a ground-based beacon radar system to an ADS-based environment. Possible surveillance applications of GPS-Squitter are depicted in Figure 1-2. In particular, GPS-Squitter is well suited for the needs of the Gulf of Mexico offshore airspace.

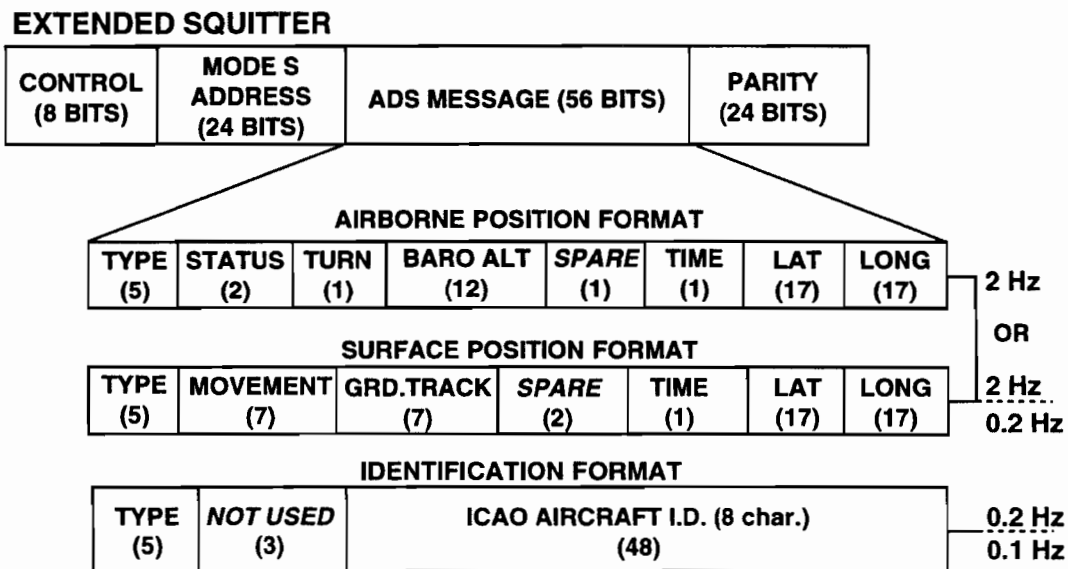

Figure 1-1. Information contained within the three types of extended squitter messages.

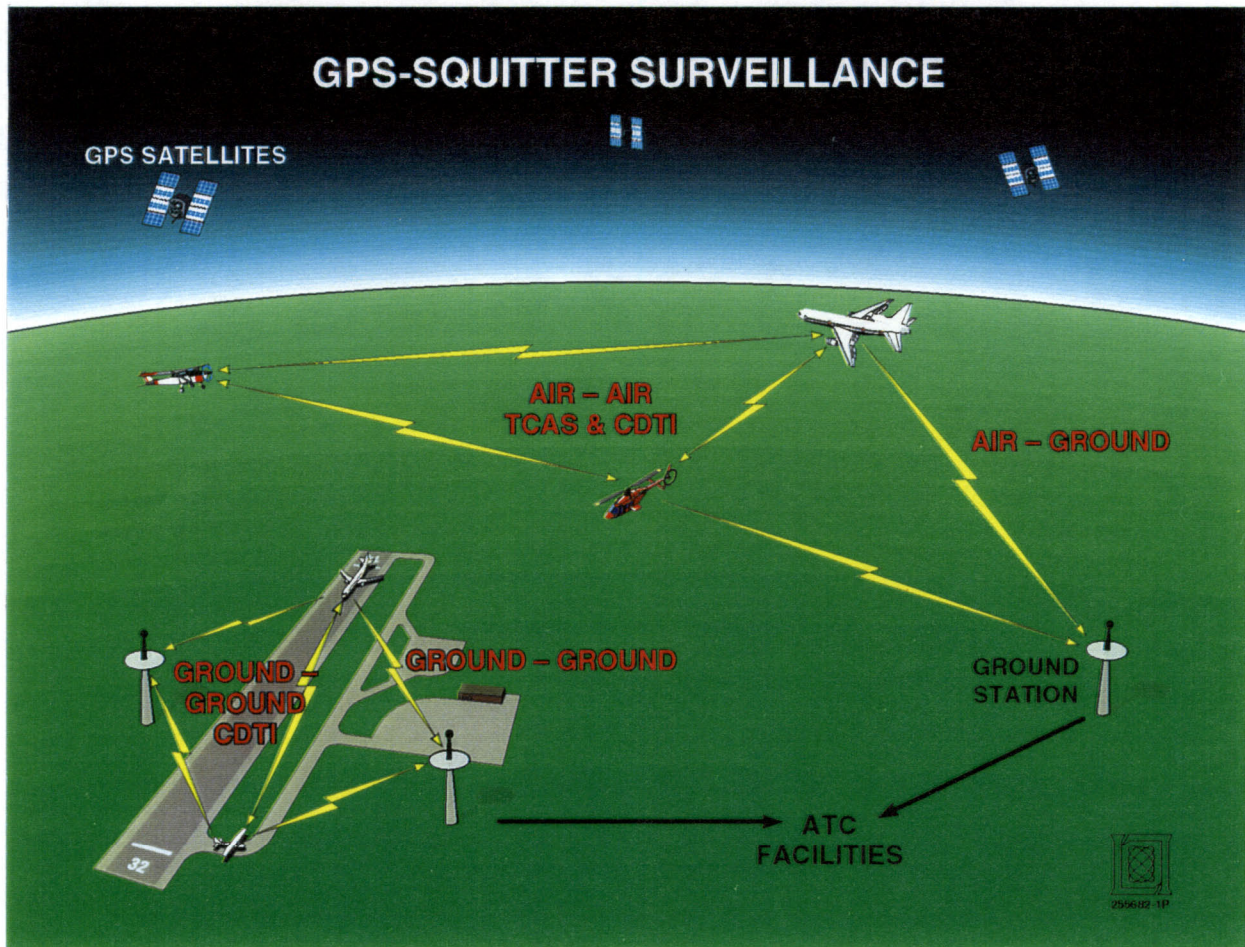

Figure 1-2. Surveillance applications of GPS-Squitter include: air-ground surveillance, TCAS (Traffic Alert and Collision Avoidance System), CDTI (Cockpit Display of Traffic Information), and surface surveillance.

1.3 REPORT OVERVIEW

The applicability of the GPS-Squitter system to Gulf of Mexico offshore operations has been demonstrated in flight test and documented in this report. Section 2 contains a description of the flight test objectives. The configuration of the avionics and ground system used for the flight test is presented in Section 3. Estimates of the predicted surveillance coverage are provided in Section 4, and the flight test results are discussed in Section 5. In Section 6, one possible configuration of a complete operational system is presented. The effect that anomalous propagation conditions might have on system performance is described in the Appendix.

2. TEST OBJECTIVES

The motivation for the Gulf of Mexico activity was the assertion that Automatic Dependent Surveillance Broadcast (ADS-B) may represent a practical method for providing electronic surveillance of low-flying aircraft operating in the portion of the Gulf of Mexico serviced by oil platform helicopters. The primary objective of the flight testing in the Gulf of Mexico was to obtain field measurements to characterize GPS-Squitter surveillance performance.

A second objective was to assess the air surveillance performance of GPS-Squitter as previous testing of GPS-Squitter had focused on surface surveillance [5, 6]. Of particular interest was a comparison of the measured surveillance range of GPS-Squitter to the predicted range for both helicopters flying at low altitude and fixed-wing aircraft at high altitude. For the low-altitude case, an appraisal of the effects of anomalous propagation conditions, such as ducting, was included in the surveillance assessment.

Another objective of the flight testing was to demonstrate to controllers and to the helicopter operators in the Gulf the surveillance performance possible with GPS-Squitter. For this reason, live traffic displays were installed at the New Orleans TRACON (Terminal Radar Approach CONTROL facility), the Houston ARTCC (Air Route Traffic Control Center), and the PHI (Petroleum Helicopters, Inc.) heliport in Morgan City, Louisiana.

The GPS-Squitter equipment used in the Gulf consisted of either commercially-available off-the-shelf (COTS) equipment or of prototype COTS equipment. A final objective was to demonstrate that GPS-Squitter is a near-term alternative for Gulf surveillance by utilizing readily-available components.

3. TEST CONFIGURATION

An overview of the equipment configuration used in the Gulf of Mexico is presented in Figure 3-1. Three GPS-Squitter ground stations were brought to the Gulf to receive squitters from three test aircraft. This section describes the aircraft, ground equipment, displays, and discusses some problems with the initial implementation and possible solutions for future demonstrations and operational systems.

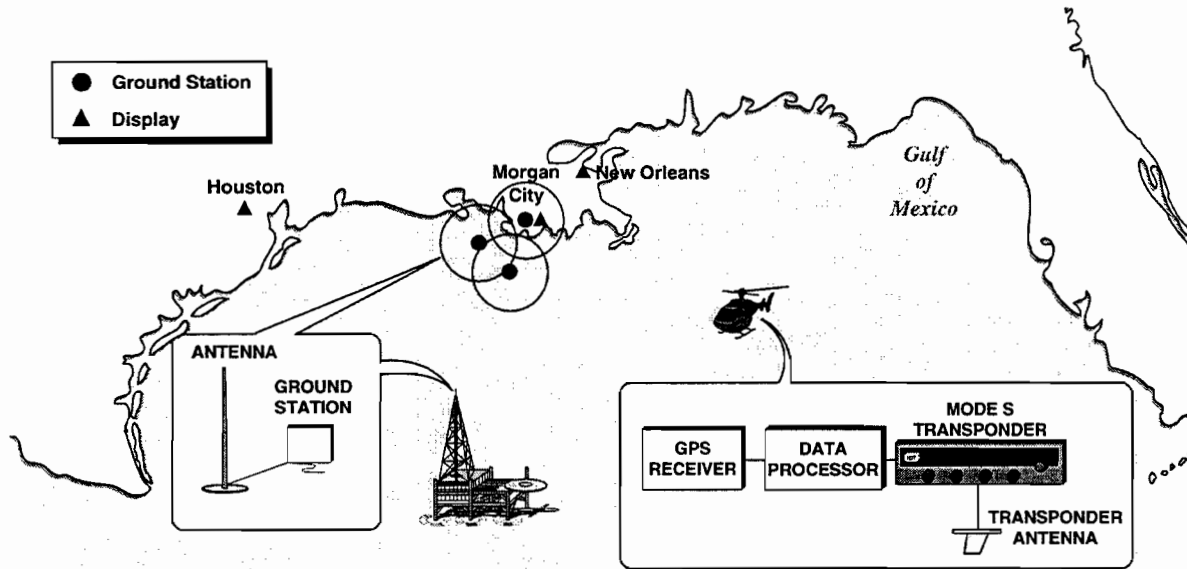

Figure 3-1. Overview of avionics and ground equipment used in the Gulf of Mexico.

3.1 TEST AIRCRAFT

3.1.1 Aircraft Types

Three aircraft participated in the GPS-Squitter testing in the Gulf—two helicopters and a fixed-wing aircraft (Figure 3-2). Both helicopters were Bell 206s, one leased from Wiggins Airways in Norwood, Massachusetts, and the other owned by PHI. The Wiggins Bell 206 was flown by a Lincoln Laboratory pilot. It served as the primary test aircraft. The PHI Bell 206 was an in-service helicopter conducting revenue flights. It served as a target of opportunity during the testing. The fixed-wing aircraft was a twin-engine Cessna 421 flown by Lincoln Laboratory pilots.

3.1.2 Avionics

To automatically transmit the GPS-Squitter messages, each aircraft was equipped with a Mode S transponder modified for extended squitter, a GPS receiver, and a data processor. Figure 3-3 details the various avionics equipment configurations. The two helicopters used

modified Bendix/King KT-70 transponders from AlliedSignal, Inc. The modified KT-70 is a data link capable Mode S transponder designed for general aviation. The Cessna 421 used a modified TPR-720 transponder from the Collins Division of Rockwell International. The Collins transponder, designed for transport aircraft, had been used previously in the GPS-Squitter testing at Hanscom Field and Logan Airport [5, 6]. The Gulf demonstration represented the first testing with the KT-70s.

GPS receivers provided the position data in all the aircraft. The Wiggins Bell 206 and the Cessna 421 both used Trimble TNL-2100 GPS receivers. These units provide time, latitude, longitude, and other navigation data at a nominal 1 Hz rate. They also have an encoding pressure altimeter input. Pressure altitude is passed along with the GPS navigation data in the TNL-2100 output data stream. The PHI Bell 206 was equipped with a Magellan Skynav 5000 GPS receiver. This unit output latitude and longitude only.

In all three aircraft, a data processor formatted position and other data obtained from the GPS receiver into a form acceptable to the Mode S transponder. Two data processors were installed in the Wiggins Bell 206—a commercially-available Line Replaceable Unit (LRU) from ARNAV and a laptop PC-compatible computer. The ARNAV 5010 LRU is a PC-compatible computer in an avionics package. Onboard data recording was possible only with the laptop computer, as the ARNAV unit has very limited I/O capability. Software for both of these processors was developed specifically for the Gulf tests. A second ARNAV LRU was installed in the PHI Bell 206 and special software was written to communicate with the Magellan Skynav 5000 GPS unit. The Cessna 421 data processor was an existing VME bus multiprocessor system that included a laptop computer for data recording. This system was previously used in the Cessna for the Hanscom Field and Logan Airport GPS-Squitter tests.

3.2 GROUND EQUIPMENT

3.2.1 Receive Stations

As shown in Figure 3-1, three ground receive stations were brought to the Gulf for the GPS-Squitter testing. Two of these were placed on oil platforms; the third was located onshore. The offshore ground stations were on a Shell Oil platform in Eugene Island Block 100 (EI 100) and on a Norcen Explorer platform in South Marsh Island Block 268A (SMI 268). The onshore ground station was installed at the PHI heliport on Lake Palourde, east of Morgan City, Louisiana. The distance from the PHI ground station to the EI 100 and SMI 268 platforms was 42 nmi and 53 nmi, respectively. EI 100 and SMI 268 were separated by 32 nmi.

The two ground stations on oil platforms used standard Distance Measurement Equipment (DME) antennas. These antennas were mounted on top of communications towers approximately 160 feet above mean sea level. The DME antenna has an azimuth-omnidirectional antenna pattern. The PHI heliport ground station used a directional antenna. This antenna was mounted on a tower approximately 90 feet above ground level and its 140° azimuth beam was centered midway between the offshore ground stations. A picture of both antennas is provided in Figure 3-4.



(a)



(b)



(c)

Figure 3-2. Aircraft used in the Gulf of Mexico testing (a) Wiggins Bell 206 helicopter, (b) PHI Bell 206 helicopter, and (c) Cessna 421 aircraft.

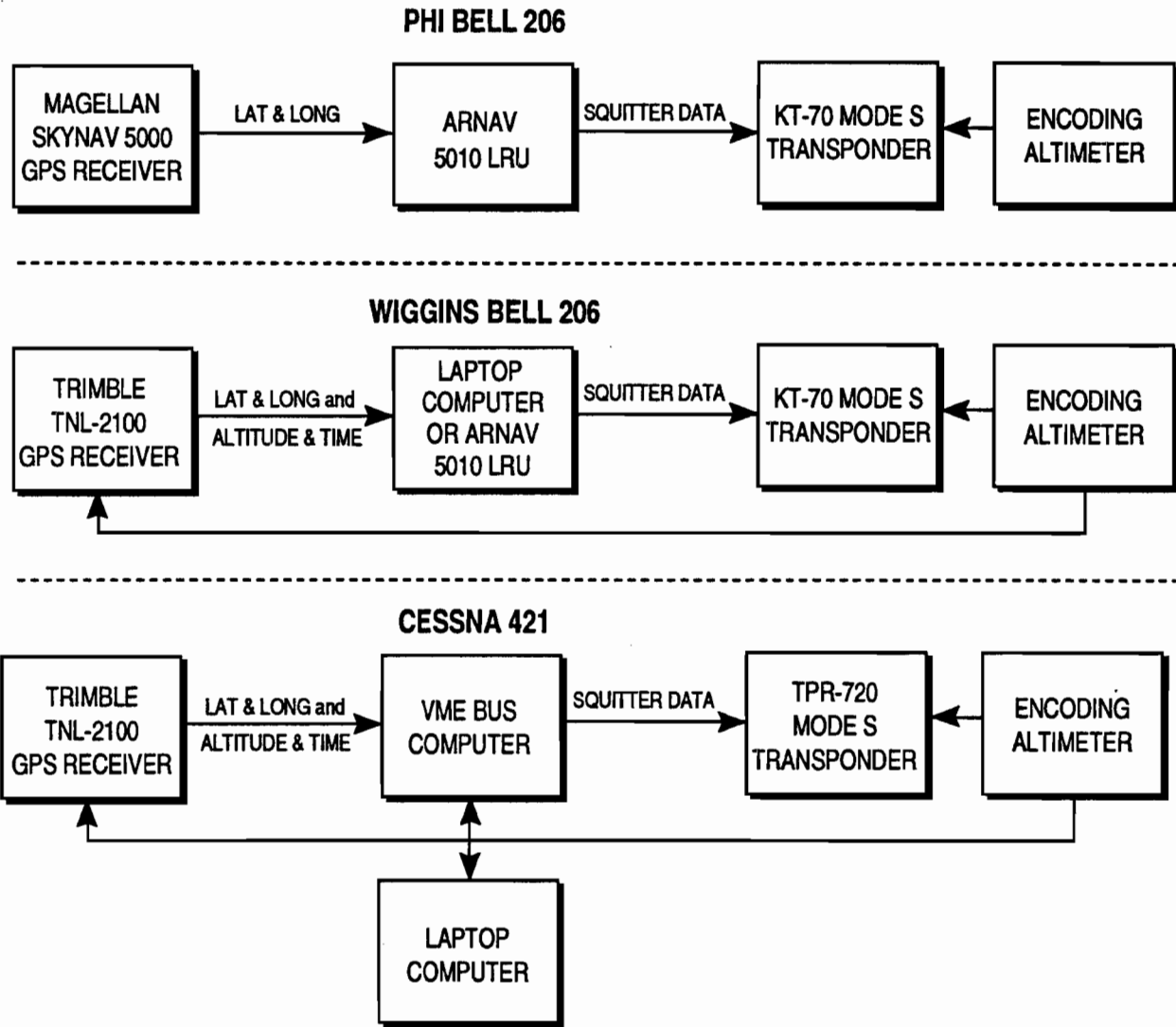

Figure 3-3. Configuration of the test aircraft avionics.

Each ground station contains a Ground Interrogator/Receiver Unit (GIRU), also pictured in Figure 3-4. The GIRU is a modified Bendix TCAS II Processor obtained from AlliedSignal, Inc. The modifications consisted of minor RF (radio frequency) hardware and software changes. The GIRUs can transmit Mode S interrogations on the 1030 MHz frequency channel and receive Mode S replies at 1090 MHz. Only the receive capability was required and utilized in the Gulf.

Figure 3-5 is a block diagram of the ground station. The GIRU receives and processes the Mode S extended squitters and sends the squitter data to a Sun workstation over a high speed (100 kbps) Arinc-429 serial interface. An interface board in the Sun workstation links the Arinc-429 serial interface to the Sun SBus.

The Sun workstation reformats squitters received from the GIRU and sends the data to the Central Control Computer (CCC) over an RS-232 asynchronous serial link at 19,200 bps. The Sun also contains local data recording capabilities, and a 4 mm Digital Audio Tape (DAT) data recorder used to transfer local data recordings to the data analysis computer. See Figure 3-6 for a photograph of the ground station equipment.

3.2.2 Communications

The Central Control Computer (CCC), located at the PHI heliport in Morgan City, received real-time surveillance data from the three ground stations. Figures 3-7, 3-8, and 3-9 provide details on the three different communication links between the ground stations and the CCC. As can be seen in the figures, each communication link was unique, and certain components were included to increase link reliability and to simplify recovery from system failures. Details on the problems associated with the communications links can be found in Section 3.3.

Figure 3-7 shows the link from the PHI ground station to the CCC. This was a direct wire link. The null modem allowed the ground station and the CCC, both RS-232 Data Terminal Equipment (DTE) devices, to transfer data between themselves. As a reminder, the RS-232 standard only allows a direct connection between a DTE device and a Data Communications Equipment (DCE) device. Other types of connections, DTE to DTE or DCE to DCE, require null modems to be inserted between the devices. A null modem is a passive item wired to perform a pairwise swap of certain RS-232 signals, so that the output drivers on one RS-232 device connect to the input receivers on the other device, and vice versa.

Figure 3-8 shows the link from EI 100 to the CCC. The ground station used a standard dial-up modem (Fastcomm FDX-9642T) with V.32bis coding and V.42 data compression. This type of modem can support up to 14,400 bps raw data rate, with higher rates possible through data compression. The modem is a wireline modem, designed to operate over the Public Switched Telephone Network (PSTN). The local telephone company provided a PSTN connection from PHI to the Shell Oil Company facility in Morgan City. Shell Communications provided a microwave link from their facility to the EI 100 platform. The microwave link extended the PSTN connection from the shore to EI 100, so the modem on EI 100 would have the appropriate signals for it to dial the modem at PHI, connect, and transfer data. At PHI, the RS-232 data from the modem were either routed into the CCC, or terminated via the RS-232 switch box. Normally, the switch box was set to route modem data to the CCC, and the CCC software commanded the ground station to enable or disable squitter data communication to the CCC. However, in the rare

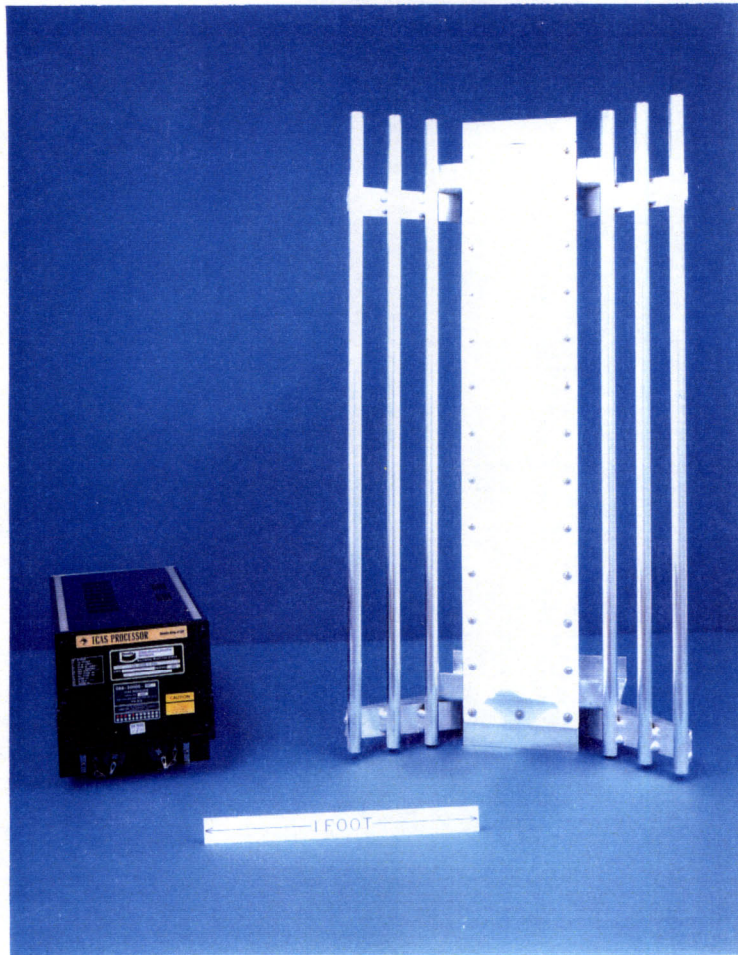

(a)

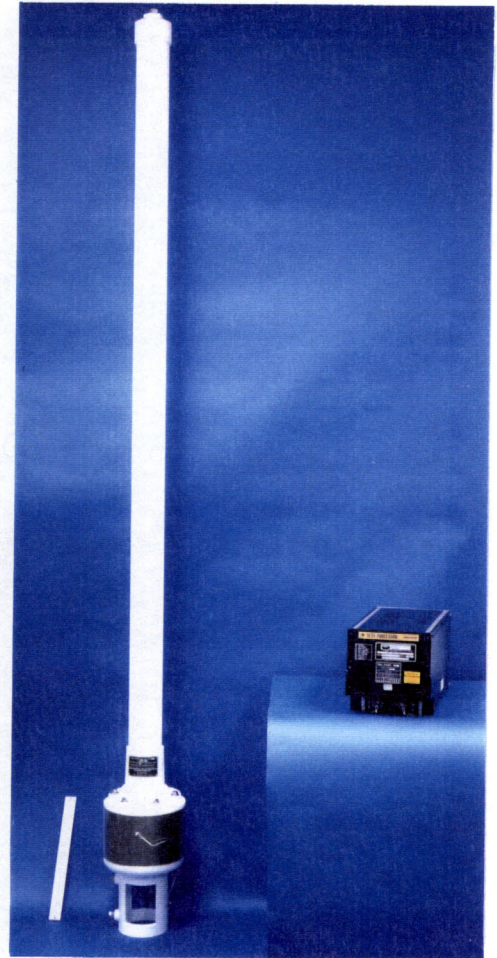

(b)

Figure 3-4. Ground Interrogator/Receiver Units (GIRUs) with antenna configurations used in the Gulf of Mexico: (a) directional antenna used at the PHI heliport, and (b) omnidirectional-in-azimuth antenna used on the oil platforms.

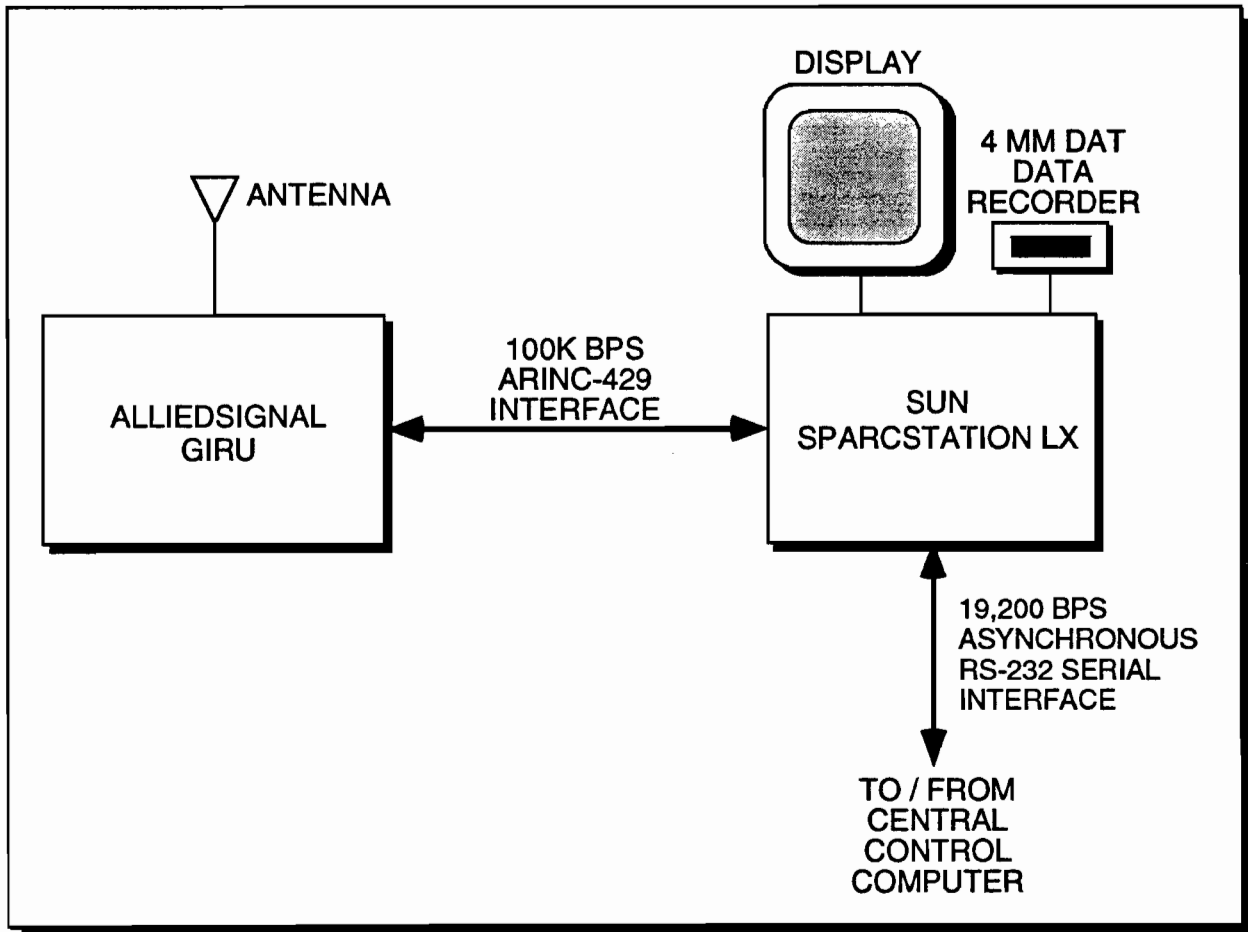

Figure 3-5. Ground station block diagram.

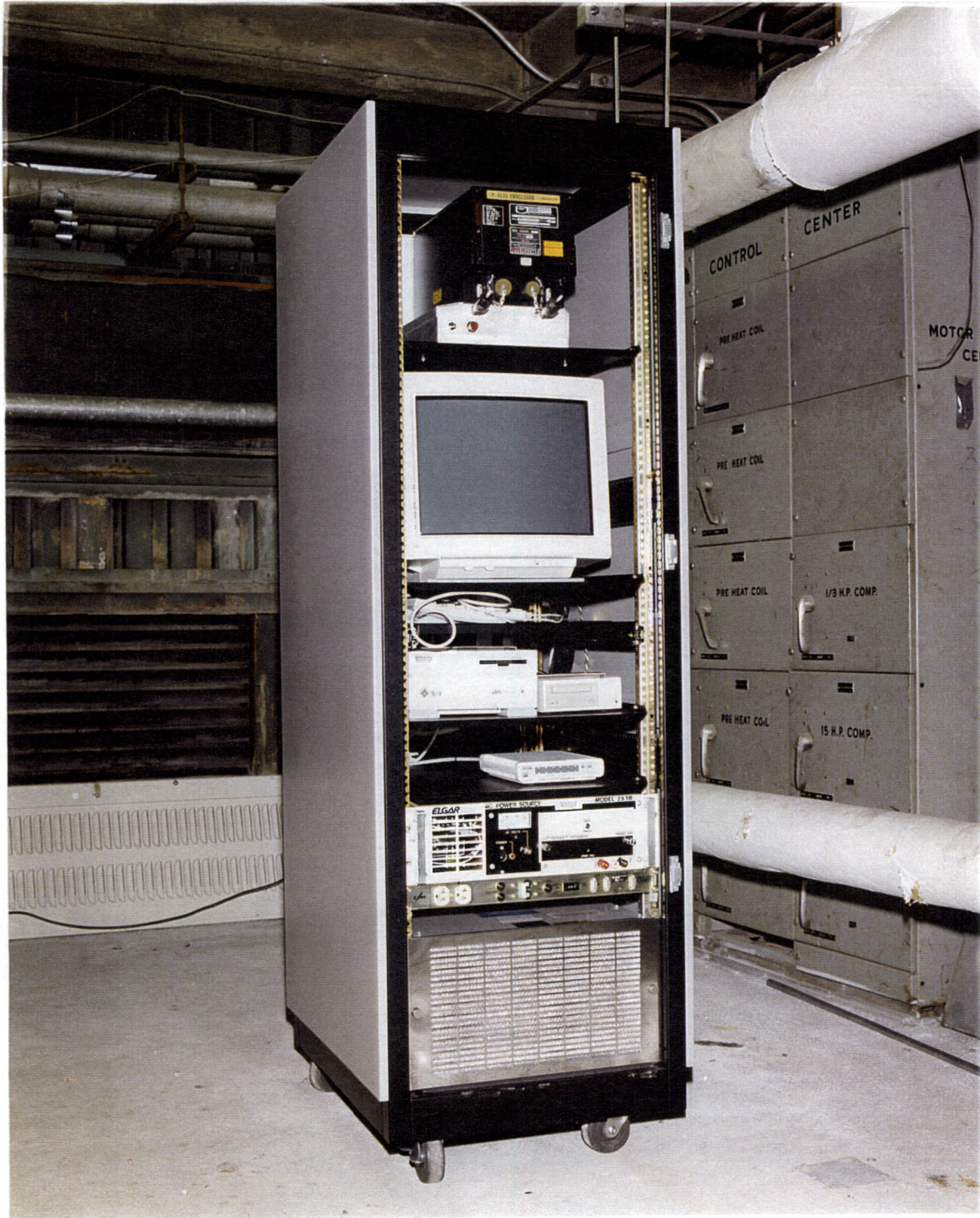

Figure 3-6. Ground station equipment rack including GIRU and Sun workstation.

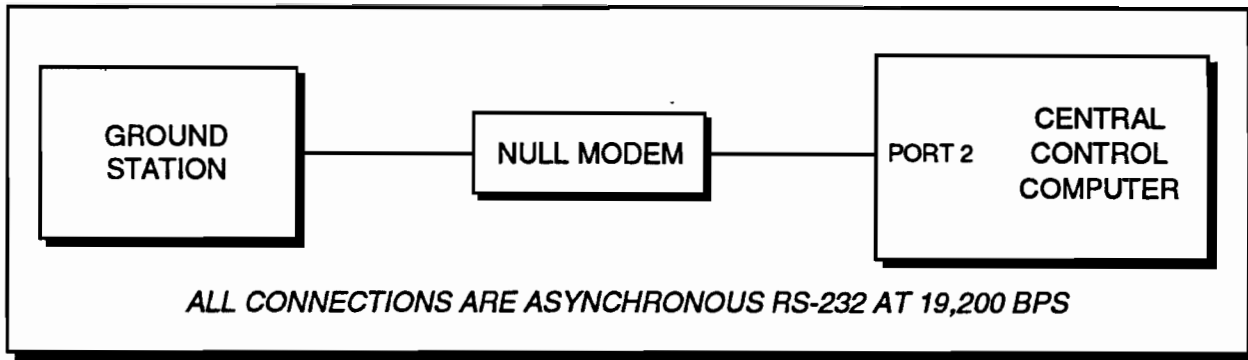

Figure 3-7. Communication link from the PHI ground station to the Central Control Computer.

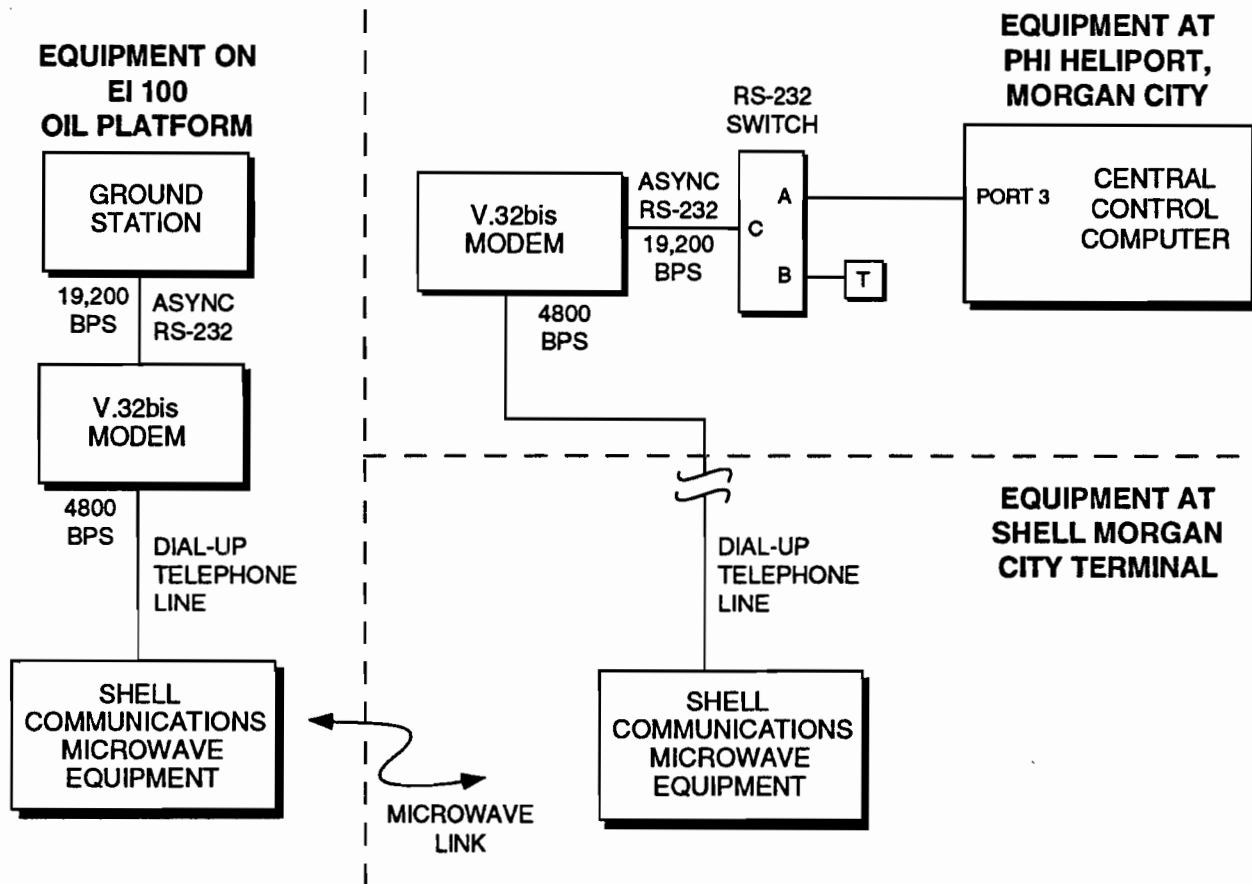

Figure 3-8. Communication link from the EI 100 ground station to the Central Control Computer.

case of a CCC software failure, commands could not be sent from the CCC to the ground station, so data from the ground station were temporarily ignored by switching the box to connect the modem to the terminator.

Figure 3-9 shows the link from the SMI 268 ground station to the CCC. PetroCom operates a cellular telephone network in the Gulf of Mexico, and uses satellite links to connect the cellular ground stations on oil platforms, including the platform in SMI 268, to their cellular switching office in New Orleans. The SMI 268 ADS-B ground station used an existing satellite digital channel to connect the oil platform to PetroCom's New Orleans facility. Dial-up modems provided the last part of the connection to the CCC at PHI over the PSTN. The digital channel on the PetroCom satellite terminal equipment at SMI 268 and at New Orleans was synchronous RS-232. PetroCom provided RS-232 async to sync converters to generate a baud rate clock and to resample and synchronize the async data to this clock. The async to sync converter is wired as RS-232 DTE device on the sync side, and RS-232 DCE device on the async side. The satellite digital channels were DCE devices, so the synchronous sides of the sync to async converters were connected directly to the satellite channels. On SMI 268, the ground station, being a DTE device, connected directly to the asynchronous side of the sync to async converter. However, at the PetroCom New Orleans facility, a null modem was required to connect the two DCE devices, modem and asynchronous side of the sync to async converter. Like the connection to EI 100, the communications link from SMI 268 to the CCC had an RS-232 switch box at PHI, so that the data could be ignored in case of a CCC software failure.

The CCC provided traffic data to displays in Morgan City, New Orleans, and Houston. Figure 3-10 shows the connections from the CCC to the local and remote display computers. The local display computer also acted as the data analysis computer, and had a printer attached to it for local hard copy of aircraft track plots and other analysis printouts. The CCC communicated with the local display in Morgan City via a direct Ethernet Local Area Network (LAN). This same Ethernet LAN also connected the CCC to two NetBlazer PN network devices with internal modems. The NetBlazer PN converted TCP/IP packets on the LAN to data packets that are sent via dial-up modem to a remote NetBlazer, which then converted the modem data back to TCP/IP packets on a second LAN. This capability allowed software on distant computers to transfer data as if the computers were physically connected to a common LAN. One NetBlazer connected the CCC to a display computer in the New Orleans TRACON; a second NetBlazer connected the CCC to a display computer in the Houston ARTCC.

Two voice communications systems were used during Gulf flight tests. When the Wiggins Bell 206 was within 10 nmi of the PHI heliport, the test director at PHI talked to the pilot on a special VHF aircraft voice frequency assigned to Lincoln Laboratory for the test. A base station VHF radio was installed next to the CCC at the PHI facility for the test director's use. The test director also communicated with the Cessna 421 on this special frequency. Communications with the Cessna 421 extended out to approximately 70 nmi, because the aircraft flew at higher altitudes than did the helicopter. All communications with the PHI Bell 206 and with the Wiggins Bell 206 beyond 10 nmi used the PHI voice radio communications network that allowed PHI flight following personnel to talk to aircraft in the Gulf.

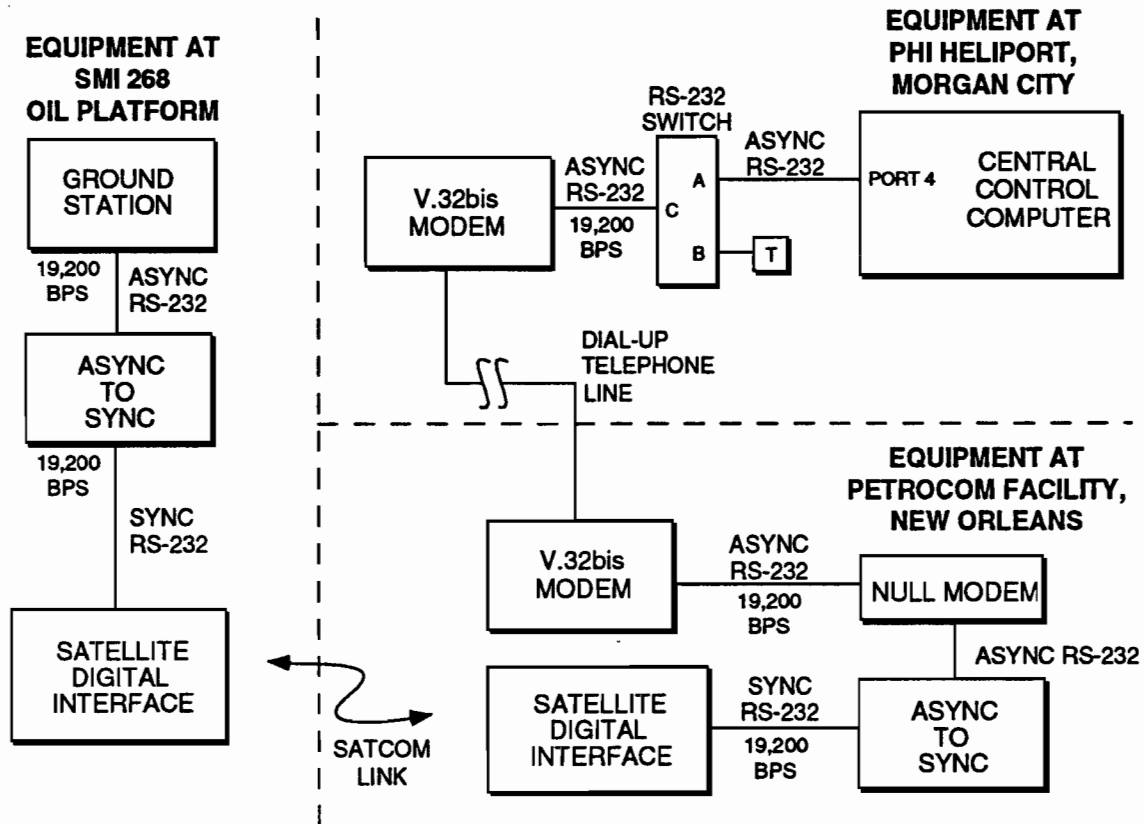

Figure 3-9. Communication link from the SMI 268 ground station to the Central Control Computer.

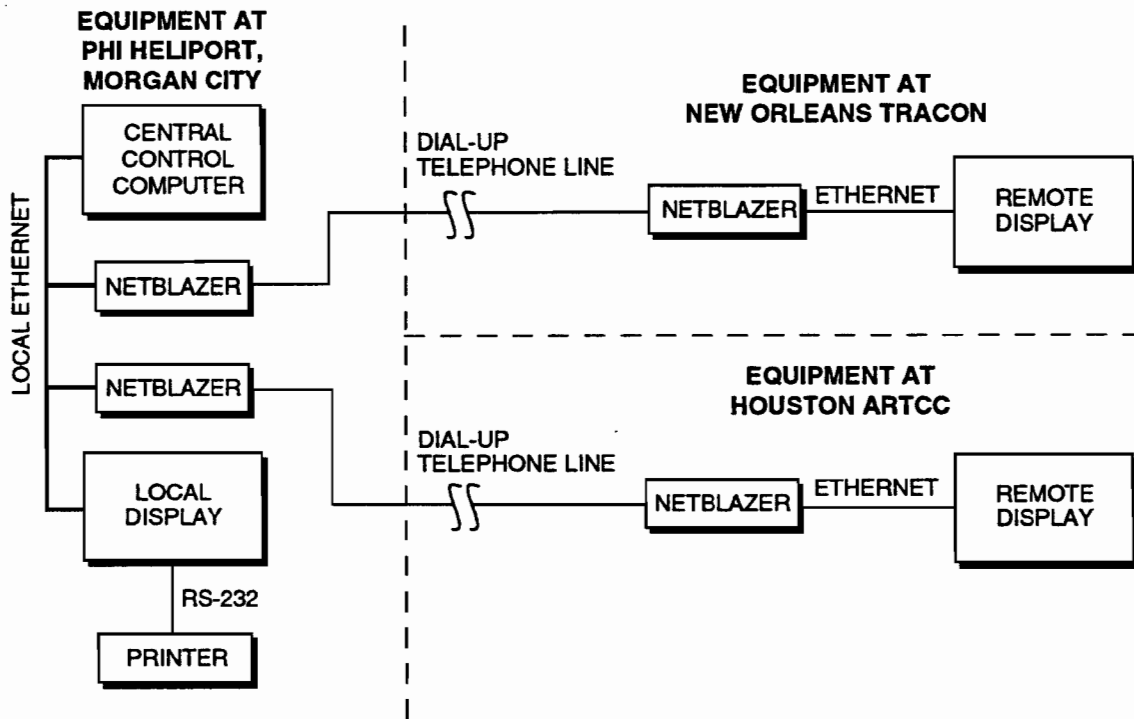

Figure 3-10. Communications from the Central Control Computer to the traffic displays.

3.2.3 Displays

One of the objectives of the testing was to demonstrate to the controllers and to the Gulf helicopter operators the quality of the GPS-Squitter surveillance. The traffic displays installed at the PHI heliport in Morgan City, at the New Orleans TRACON, and at the Houston ARTCC provided a means to display traffic data in real-time, and also to playback recorded traffic data. An example of the data available on the display is shown in Figure 3-11.

All three of the test aircraft appear in Figure 3-11. A symbol represents the location of an aircraft and a data tag provides information regarding the aircraft. The top line of the tag is the ICAO identification which is received in the extended squitter identification message. For the aircraft in Figure 3-11, the ICAO identification is the aircraft's tail number. The bottom line of the tag contains altitude followed by ground speed. As is the case with typical ATC (Air Traffic Control) displays, altitude and ground speed are given in hundreds of feet and tens of knots, respectively. The displayed altitude is based on the barometric altitude field in the extended squitter position messages. The values received in the squitter messages were adjusted using the same barometric pressure corrections applied at the New Orleans TRACON. The final block in the data tag, ground speed, is calculated by the CCC based simply on the change of aircraft position with time.

The locations of the test aircraft shown in Figure 3-11 are superimposed on a background map of the area. This electronic map included the Gulf coastline, major roads, and symbols indicating the location of the three ground stations. Also included were the locations of the nearby VORs as well as the VOR radials typically flown during IFR conditions. The VORs were White Lake (LLA) and Tibby (TBD).

3.3 COMMUNICATIONS PERFORMANCE ISSUES

There were occasional problems with the communications links to the ADS-B ground stations on EI 100 and SMI 268. The problem with the EI 100 link was the mismatch between the dial-up modems and the microwave link back to shore. The problem with the SMI 268 link was the corruption of squitter data being sent from the ground station to the CCC, and the inadequacy of the data and checksum protocol, implemented for the Logan Airport tests, when used over a satellite data link.

On EI 100, the microwave link provided a PSTN telephone connection for the Fastcomm modem. However, the telephone signaling levels were not well matched between the microwave link and the modem, and the occasional dropouts and other perturbations in the microwave link would cause the dial-up modem to detect a line failure, and to hang up. The Sun software in the ground station, detecting the loss of carrier from the modem, would automatically exit and shut down. Also, the microwave link was not suitable for the full speed V.32bis modulation (14,400 bps) of the Fastcomm FDX-9642T. To have a modem connection that lasted longer than 10 minutes, the originating modem on EI 100 had to be instructed to use a lower baud rate (4800 bps) over the telephone line. This lower data rate was acceptable during the testing in the Gulf.

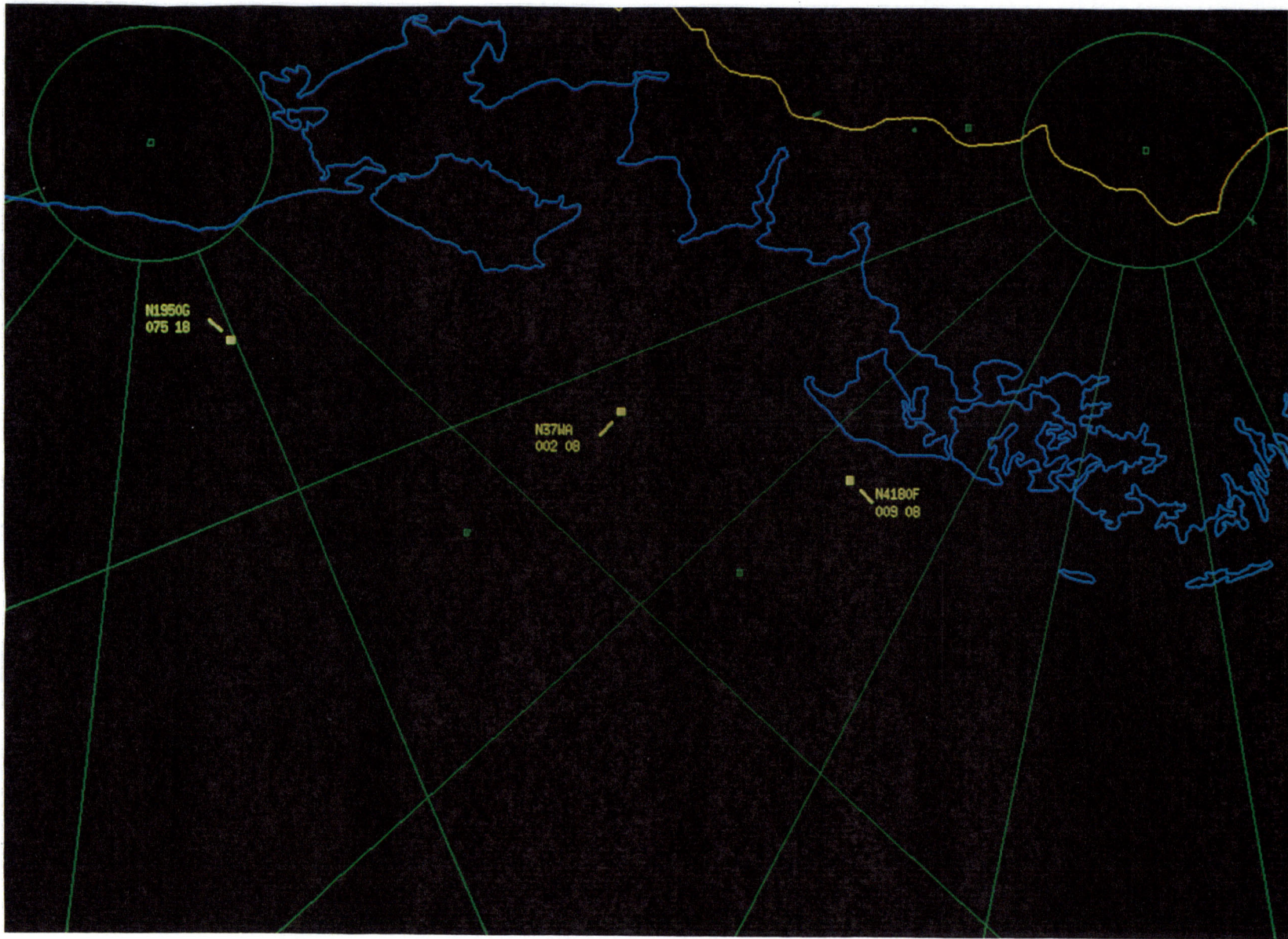

Figure 3-11. Traffic display showing test targets, VOR radials, ground station locations, Gulf coastline, and major roads.

The best solution to the microwave problem is to use dedicated, leased line modems on the microwave link. The communications technicians from Shell report that they use the microwave link with leased line modems, and that the modem links are reliable. A hybrid connection, with leased line modems from the oil platform to shore, and dial-up modems on the PSTN from the microwave shore terminal to the CCC site, would most probably offer a robust link.

On SMI 268, the link from the oil platform to the shore is a data channel on the satellite link PetroCom uses primarily to handle cellular telephone voice channels. The data channel was a synchronous-only device, so the async to sync converters were installed to convert async RS-232 to sync RS-232, and vice versa. During a typical test, the data stream from the SMI 268 ground station would have 50 to 100 packets per hour fail the checksum test, because the data was being corrupted either by the satcom link or by the async to sync converters. Data packets that failed the checksum test were discarded, as there was neither error correction or retransmission of erroneous data packets. Also, the modem connection from New Orleans to PHI would occasionally fail, most probably due to intermittent problems on the PSTN.

As a result of the SMI communications link problems, the software in the CCC had to be improved several times to make the serial input task more robust in the face of corrupted data. Previously, at the Logan Airport site, three of the ground station communications links used Fastcomm FDX-9642T modems over the PSTN; the fourth link used a spread spectrum radio data link. All of these links were inherently very reliable, so a simple checksum system was implemented to protect against the occasional bad bit. In the Gulf, the bad bits happened so frequently, and in so many unexpected ways, that the original software was unable to perform reliably. New software tests were devised to overcome some of the problems. These tests improved the error handling capability of the CCC so that it could recognize and reject the 2 percent to 3 percent of message packets that were corrupted. However, one difficulty that was impossible to overcome was the use of a variable length binary data packet format between the ground station and the CCC. The variable length format made it impossible to locate the checksum byte without first having to read several bytes in the message to determine its length. If the length bytes were corrupted, the CCC improperly processed the serial stream, and would occasionally fail. Also, since the data were binary, it was impossible to scan for a header byte to delimit one message packet from another, as a data byte may have the same bit pattern as a header byte.

Should this system be used operationally, a more robust, standard communications protocol should be used such as synchronous RS-232 serial link with High-Level Data Link Control (HDLC) link level protocol for ground station to CCC communications. Synchronous RS-232 provides a slightly higher data throughput and does not require async to sync converters on the satellite channel, and HDLC on a sync serial link is a bit oriented protocol that includes eight bit flags at the start and end of the data packet and a sixteen bit Frame Check Sequence (FCS) located immediately before the end flag. The HDLC protocol includes a feature that inserts bits in the data stream to ensure that no consecutive eight bits inside the packet matches the eight bit flag. This scheme allows the HDLC receiver to locate the flag at the end of the packet, and then verify the FCS without having to use any data bits to determine message length. Additionally, an HDLC link can be configured to acknowledge each message, so that messages that are received with errors can be retransmitted if desired. A more complete description of HDLC can be found in ISO/IEC 3309 [7].

4. PREDICTED COVERAGE

Each ground station's maximum coverage range is reached when the signal strength at the receiver becomes too weak to reliably maintain link connectivity. This happens, for line-of-sight links, when the range becomes too great for the transmitter's effective radiated power, or when the surface-bounce signal effectively cancels the direct signal. It also happens when the increasing range of the aircraft takes it below the radio horizon of the ground station.

For the two ground stations installed on oil platforms, the multipath bounce point is always on the water surface. In this case, a good approximation for the reflection coefficient magnitude is -1.0. That is because, at the low elevation angles which are of principal interest here, the signal is reflected with very little loss of strength, and with a 180° phase reversal, independently of both the polarization and whether the water surface is rough or smooth [8]. The reflection geometry is specular.

Thus, for these ground stations, a good estimate of the received signal is that it is the sum of the direct signal and the multipath signal. The level of the direct signal is the same as it would be in free space, taking account of any antenna directivity at each end of the link. Since there is no significant reflection loss, and since the multipath range is not significantly different from the direct range, the multipath signal differs in amplitude from the direct signal only by the amount by which, at each end of the link, the antenna gain in the multipath-signal direction differs from that in the direct-signal direction. The phase difference between the two signals is precisely the electrical path length difference between the two, expressed in degrees, augmented by the further 180° surface-reflection reversal. Of course, every inch of range difference between the two paths is significant for the calculation of phase difference.

For the ground station on land, however, the multipath bounce point is always on the land, which, for the PHI ground station, is wooded. A good approximation for the reflection coefficient here is that it is zero. That is because the reflection from the tree tops is diffuse rather than specular, which means that the level of the reflected signal, at the receiver, is negligible compared with that of the direct signal. In this case, the only significant contribution at the receiver is that of the direct signal. Its amplitude, as long as the line of sight is clearly unobstructed, is equal to the free space amplitude. As the line of sight drops toward the tree tops, however, the signal will fade steadily away, reaching a level of essentially zero when the elevation angle reaches zero. (The point at which the effect of the horizon first begins to be significant is when it encroaches on the first Fresnel zone. The Fresnel zone is the ellipsoid whose foci are at the two terminals and whose surface is defined by the locus of points whose distances from the foci, when summed, are a half wavelength longer than the inter-focal distance.)

Finally, there is an adjustment to the model that needs to be applied at all three ground stations. This is the adjustment to the effective earth radius to account for atmospheric refraction. In average weather conditions, the refractive index of the atmosphere decreases as a function of height. This causes the signal path at radio frequencies to curve slightly toward the earth; in effect, it moves the radio horizon further away than the optical one. The standard way of accounting for this effect is to retain the assumption that the signal paths are straight but use for the radius of the earth a distance that is greater than the true value by 33.3%. This is known as the four-thirds earth radius model.

Figures 4-1 to 4-3 are representative examples of the result of applying these principles to estimate the link margin as a function of range for the three ground stations. Figure 4-1, in which the aircraft flies at a constant altitude of 2000 ft, applies to one of the many scenarios included in the demonstration. For the PHI ground station, whose antenna is directional in azimuth, the curve applies to the 100° wide sector defined by the flat top of the azimuth beam shape. In addition, since the horizon for the PHI ground station is defined by the tree tops, the antenna height and the aircraft altitude used in the calculations were both 40 ft less than their values (90 and 2000 ft) referred to the surface. Table 4-1 lists the assumed values for the other link budget items involved in preparing these figures.

Table 4-1

Link Budget Items

Transmit Power (W)	200
Transmit antenna gain (dB)	0
Receive antenna gain (dB)	10 (land), 8 (platform)
Cable loss (dB)	3
Receiver detection threshold (dBm)	-82.5

In interpreting the curves, one needs to bear in mind that the refractive properties of atmosphere and the sea surface are constantly changing, so the assumptions on which the propagation model is based are neither precise nor unchanging. This means that the depth and location of the multipath nulls will not be stable and that the maximum range will vary.

Some salient features of the curves are:

- For the SMI 268 and EI 100 ground stations, the striking comb-like sequence of multipath nulls, which potentially can break the link connectivity. However, at short ranges, the nulls have no serious system impact because they do not maintain their depth or position consistently; they are fairly narrow, and the average link margin is good. The nulls do become a factor at longer ranges since the width of the nulls increase with range and the average link margin is lower.
- In contrast, a complete absence of nulls for the PHI ground station.
- The greater maximum coverage range of the platform ground stations, in spite of their smaller antenna gain. This is due to the combined effects of their greater antenna height and the periodic signal enhancement by the multipath contribution.

The curves for other aircraft heights are similar to these. The trends in the differences are principally that when the aircraft flies higher, the maximum coverage range is greater, and the null density increases.

Extracted from the margin curves is the list of expected maximum coverage ranges shown in Table 4-2. The margin threshold used to define these ranges was the 4 dB level marked on the margin graphs as a dashed line. (This particular value was chosen because a statistical survey of aircraft antenna gains [9] reported that more than 99 percent of the time the gain of one or other of

the two TCAS antennas on an aircraft in level flight, in the direction of the receiver, is greater than -4 dBi.) These estimated maximum coverage ranges are not a perfect demarcation, however. The presence of the multipath nulls at shorter ranges will cause the occasional loss of a squitter from aircraft flying within the maximum coverage range. On the other hand, the high probability of the aircraft antenna gain exceeding the threshold of -4 dBi will lead to squitters being received from aircraft flying beyond the estimated maximum coverage range. Propagation anomalies can also lead to enhanced or diminished coverage.

A comparison of the model predictions with the data gathered during the demonstration is presented in Section 5.4. The conclusion reached there is that the data support the model. That is to say, the propagation model constructed to evaluate the expected performance of the demonstration surveillance system was shown to be accurate.

It should be noted, however, that this model will need to be adjusted before it can be used for the different purpose of designing a surveillance system for highly reliable year-round operation. It must take into account the additional uncertainties of aircraft transmitter power output and anomalous propagation. The effect of the latter are discussed in the Appendix. Certain system parameters are identified there which should be set appropriately to achieve reliable operation.

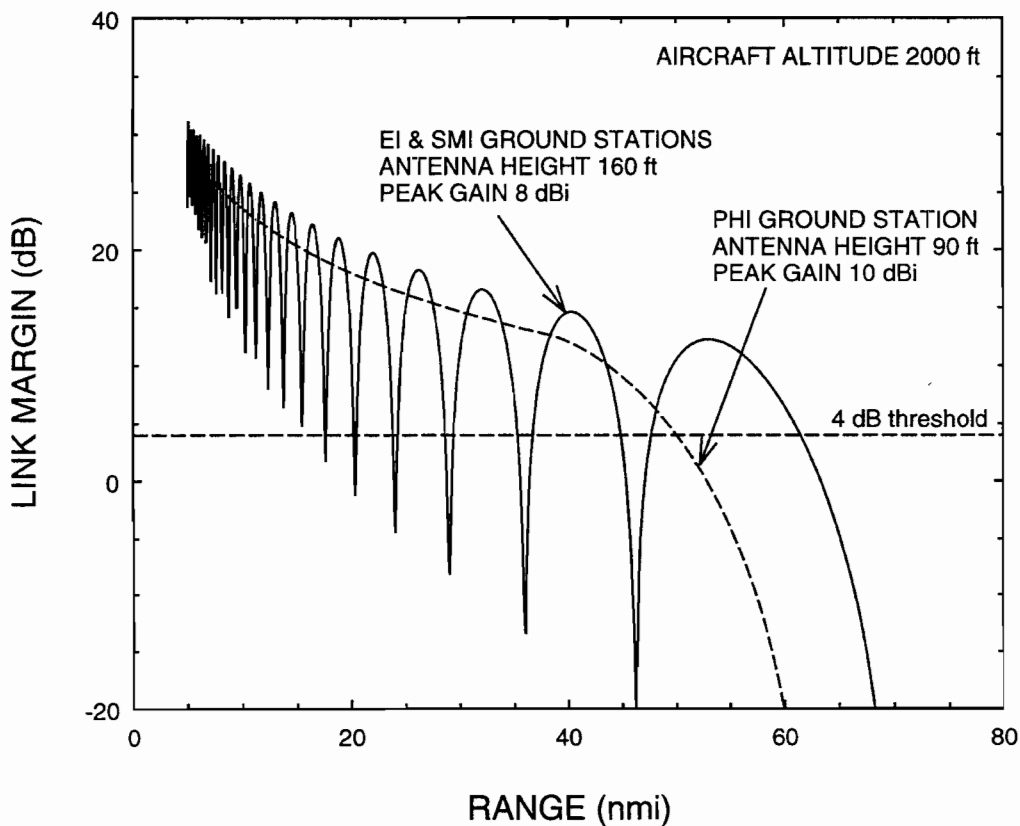

Figure 4-1. Ground station link margin for an aircraft at 2000-ft altitude.

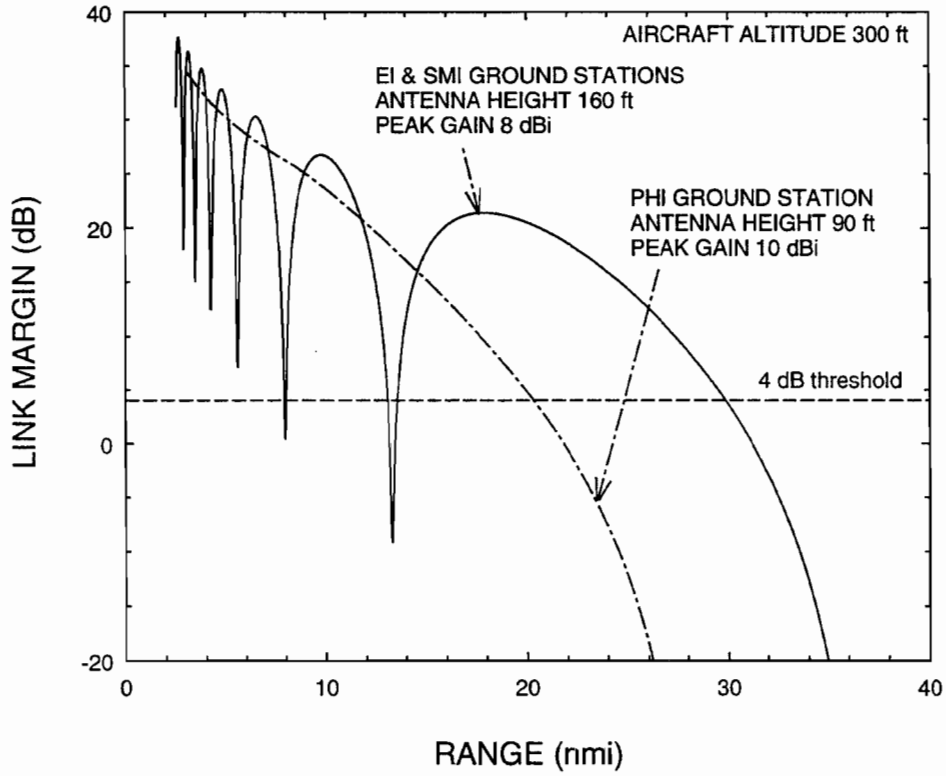

Figure 4-2. Ground station link margin for an aircraft at 300-ft altitude.

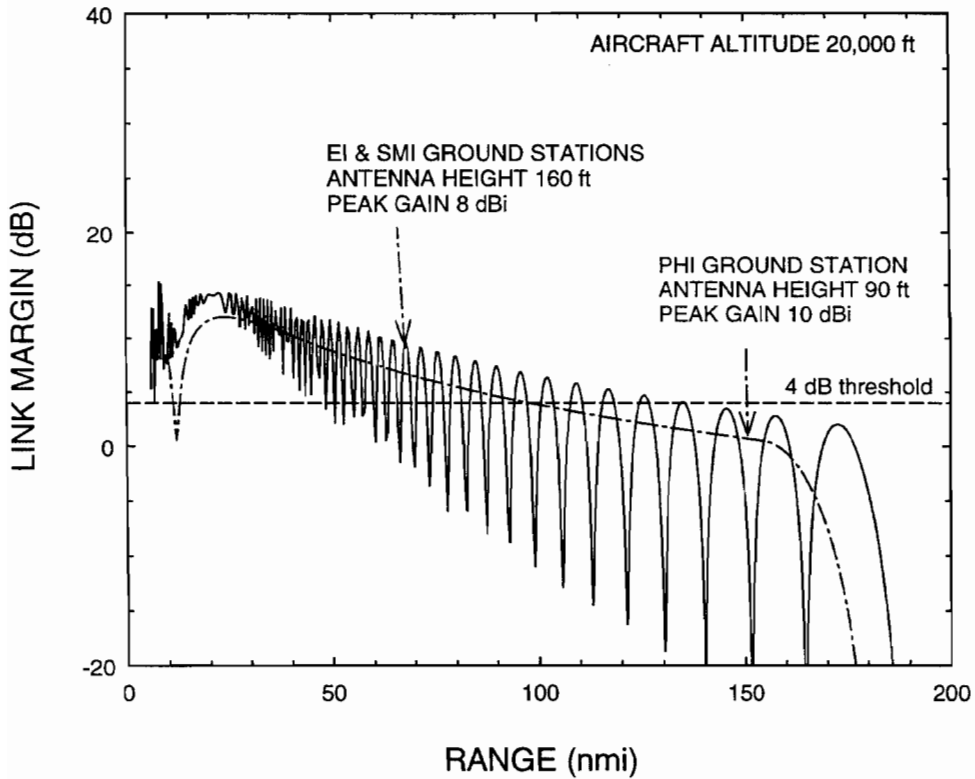

Figure 4-3. Ground station link margin for an aircraft at 20,000-ft altitude.

Table 4-2

Predicted Ground Station Surveillance Range With a 4 dB Link Margin

Aircraft altitude (ft)	Maximum coverage range (nmi)	
	PHI	SMI 268 & EI 100
100	11	21
300	20	30
600	28	38
2,000	50	62
5,000	78	92
7,500	94	110
20,000	100	136

5. FLIGHT TEST RESULTS

During November and December 1994, GPS-Squitter flight tests were conducted in the Gulf of Mexico. The three test aircraft described in Section 3.1 made numerous flights during this period at various altitudes. This section provides results from the flight testing.

5.1 WIGGINS BELL 206 HELICOPTER

Flight tests with the Wiggins Bell 206 helicopter were designed to assess the surveillance coverage between the PHI ground station and each of the offshore ground stations. The Wiggins Bell 206 flew from the PHI heliport to the SMI 268 and EI 100 platforms at altitudes of 100, 300, and 2000 ft. The lowest altitude flown, 100 ft, is well below the minimum en route VFR altitude used in the Gulf; the highest altitude, 2000 ft, represents an upper bound on the altitudes typically flown during VFR conditions. The ground stations were sited to provide continuous surveillance of helicopters flying between the stations at 300-ft altitude or higher. The results from flights at 300 ft demonstrated that this was indeed the case.

The antenna pattern of the transponder antenna on the Bell 206 did have an affect on the surveillance performance during the flight testing. A short discussion on the antenna pattern is, therefore, provided before the flight test results for the helicopter are presented.

5.1.1 Transponder Antenna Pattern

The transponder antenna for the Wiggins Bell 206 is mounted on the underside (Figure 5-1), the standard location for transponder antennas on helicopters. There are many other objects mounted on the Bell 206's underside including: the helicopter's skids, other antennas, and a metal tank containing compressed gas (for inflating the floats that are tied to the skids). All of these objects affect the transponder's antenna pattern.

Prior to deploying the helicopter to the Gulf, a test was conducted at Hanscom Field in Bedford, Massachusetts, to measure the antenna pattern. During this test, the helicopter performed several pedal turns as it hovered over a fixed location. A device known as the Airborne Measurements Facility (AMF) [10] was used to record the amplitude of the extended squitters radiated by the transponder antenna. The AMF was located at surface level and the elevation angle to the helicopter was approximately 3 degrees. The variations in received amplitude as the helicopter turned were used to determine the relative gain of the transponder antenna as a function of look angle. A plot of the antenna pattern is shown in Figure 5-2.

The antenna pattern contains nulls in certain directions. In particular, there is a substantial null (approximately 20 dB below isotropic, i.e., -20 dBi) near the tail of the helicopter possibly caused by the metal tank mounted just behind the transponder antenna. Near the front of the aircraft and near broadside the gain of the antenna is fairly good.

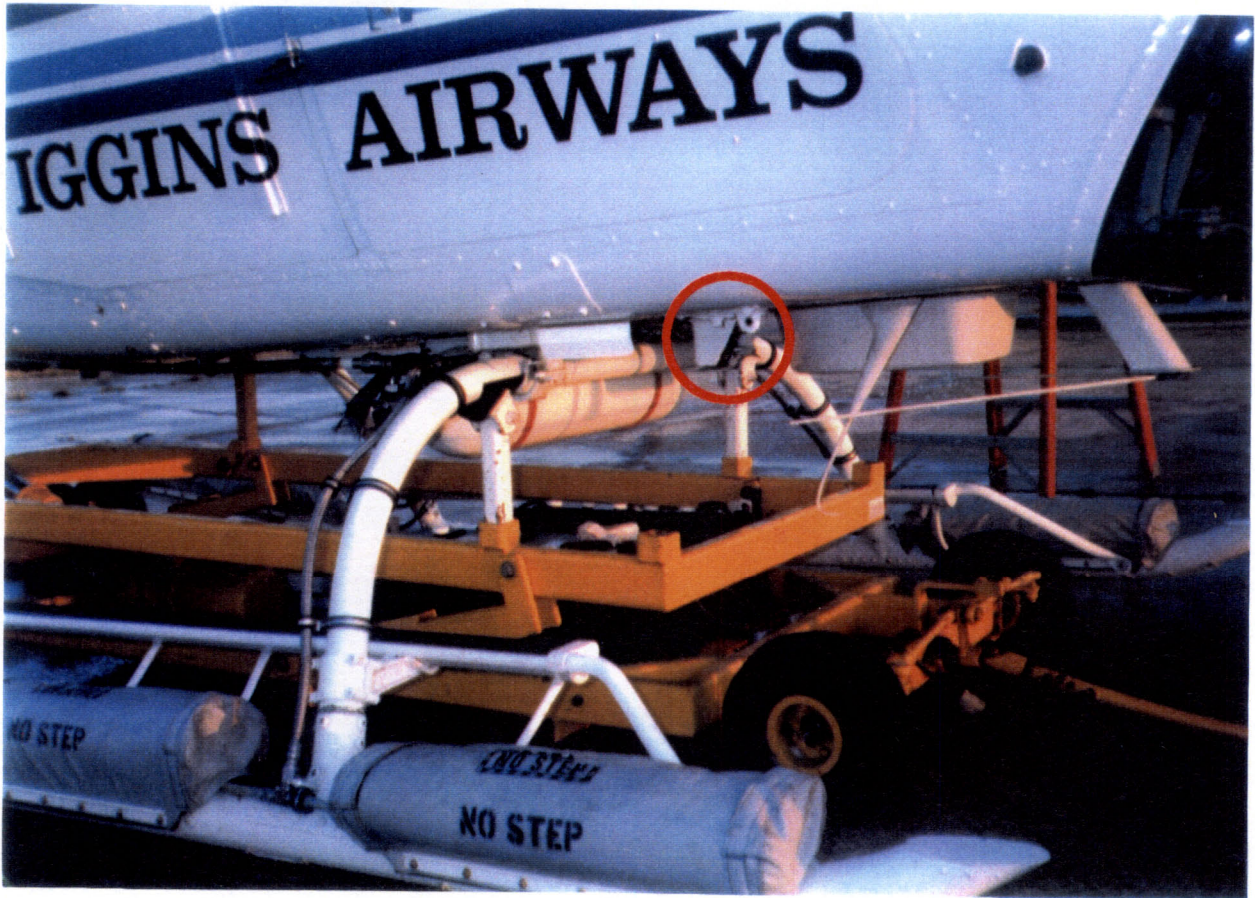

Figure 5-1. Transponder antenna mounted on the underside of the Wiggins Bell 206 helicopter.

5.1.2 Flights at 100-ft Altitude

For flights at 100-ft altitude, the Wiggins Bell 206 flew directly from the PHI heliport to the offshore ground station sites and back. Near each platform, the Bell 206 hovered at the landing pad level (approximately 50 ft above the water) before returning to the PHI heliport. The Wiggins Bell 206 was equipped with a radar altimeter that was used to maintain an altitude of 100 ft as much as possible. However, some deviations from the 100 ft level were necessary, especially over land.

The results of a flight from the PHI heliport to SMI 268 are shown in Figure 5-3. This figure is divided into four plots—the first three, Figures 5-3a, 5-3b, and 5-3c, show the individual coverage from the ground stations at PHI, SMI 268, and EI 100, respectively. The fourth plot, Figure 5-3d, shows the combined coverage from all three stations.

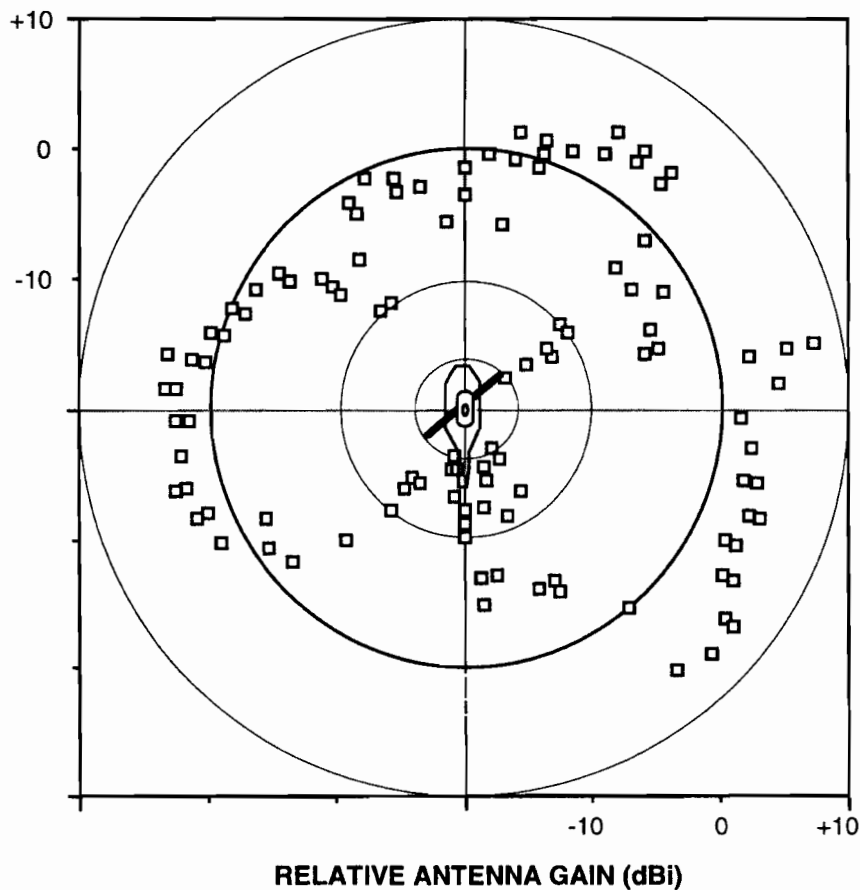

Figure 5-2. Antenna pattern for the Wiggins Bell 206 transponder antenna.

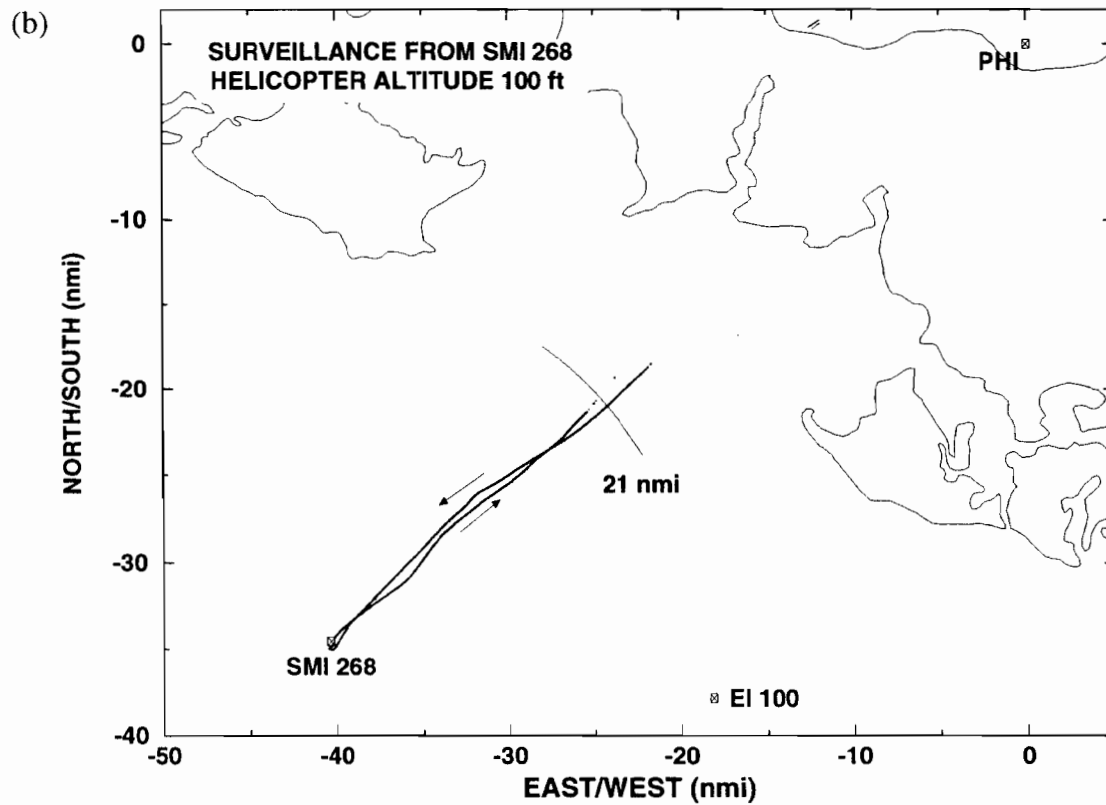
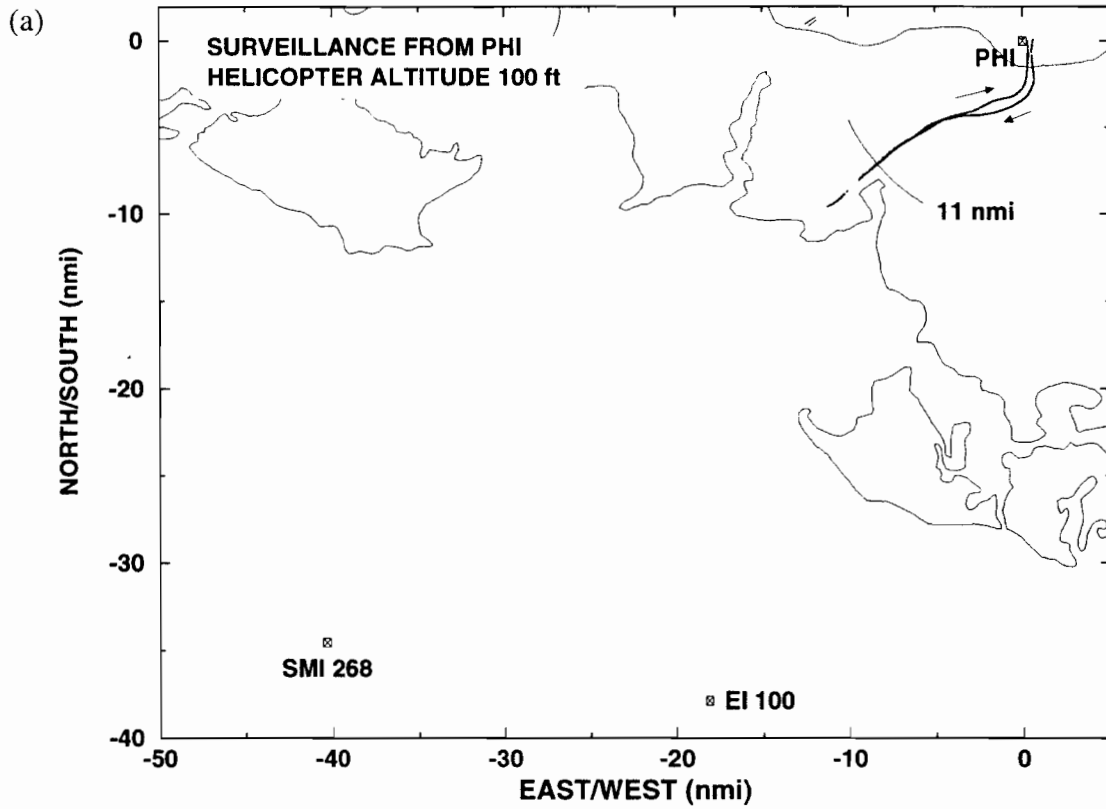

Figure 5-3a-b. GPS-Squitter surveillance of the Wiggins Bell 206, during a flight to SMI 268 at 100-ft altitude, from the ground station at (a) PHI and (b) SMI 268.

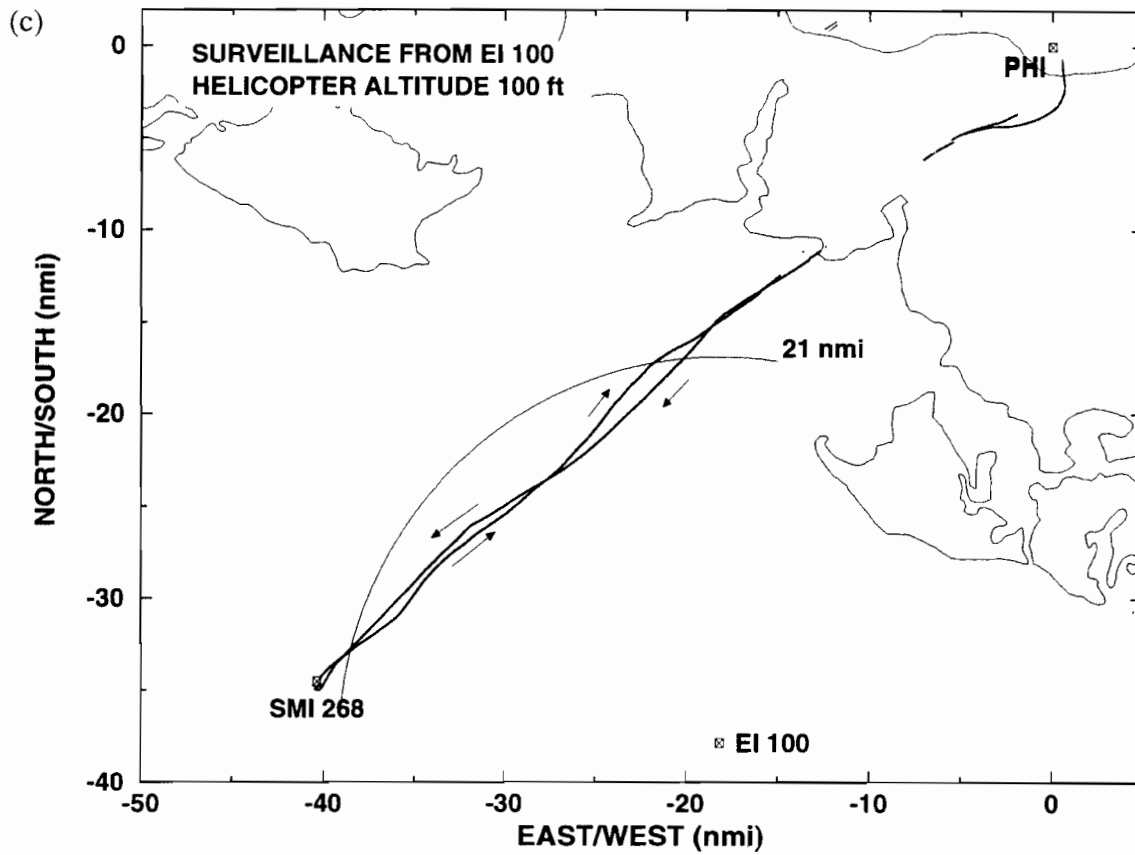

Figure 5-3c. GPS-Squitter surveillance of the Wiggins Bell 206, during a flight to SMI 268 at 100-ft altitude, from the ground station at EI 100.

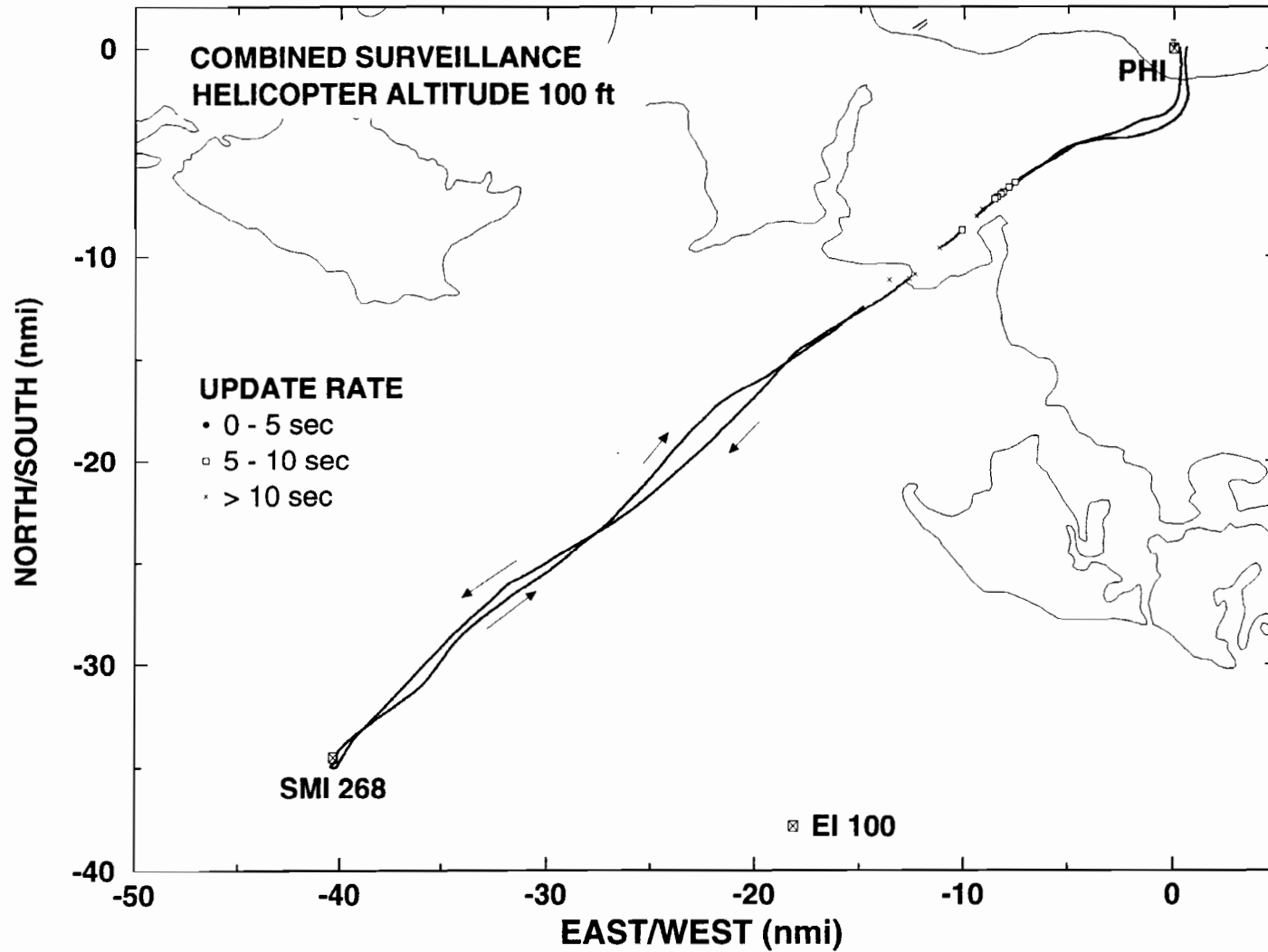

Figure 5-3d. GPS-Squitter surveillance of the Wiggins Bell 206, during a flight to SMI 268 at 100-ft altitude, from the three ground stations combined.

In Figure 5-3a, an arc is drawn at a radius of 11 nmi from the PHI ground station. This is the predicted coverage range for an aircraft at 100-ft altitude for this ground station as explained in Section 4. Similarly, arcs at a radius of 21 nmi from the SMI 268 and EI 100 ground stations are shown in Figure 5-3b and 5-3c. This represents the predicted range for the offshore ground stations. For the PHI and SMI 268 cases, the agreement between the predicted and actual coverage is, in general, quite good. There is, however, an imbalance between the coverage of the helicopter when it was flying toward SMI 268 versus flying away from this ground station. When flying toward SMI 268, a solid track was initiated at 25-nmi range, and in the other direction the solid track was lost at ~20-nmi range. This probably is due to variations in the antenna pattern for the helicopter's transponder. As shown in Figure 5-2, there is a null in the pattern near the tail of the helicopter while no similar null exists near the front section.

The EI 100 ground station performed slightly better than predicted during the flight. A solid track was obtained when the helicopter was within 25 to 27 nmi of EI 100 versus the predicted range of 21 nmi (Figure 5-3c). The difference could be due to the fact that the antenna pattern for the helicopter has increased gain near both the port and starboard broadside locations.

Different symbols are used in the combined coverage plot of Figure 5-3d. These symbols provide an indication of the surveillance update rate attained during the flight. A small solid dot is used to represent a position update that was received within 5 sec of the previous update; a square is used for updates that were received 5 to 10 sec apart; and an X is used to represent an update that was received more than 10 sec after the preceding one. For comparison, terminal area surveillance radars typically provide an update rate of once per 5 sec and en route radars provide an update rate of 10-12 sec.

There is a 5-10 nmi wide coverage gap between the SMI 268 and PHI locations. This is not surprising since the siting of the stations was chosen to provide continuous surveillance at altitudes of 300 ft and above. The gap is due to the radar horizon limitation and can be overcome by either reducing the spacing of the ground stations or by increasing the antenna height of the ground stations (the latter solution is feasible for onshore stations, but would be difficult for the offshore sites).

Figure 5-4 shows results from a flight taken with the Wiggins Bell 206 from the PHI to the EI 100 ground station. The results are presented in the same manner as those in Figure 5-3. The coverage from the PHI ground station in Figure 5-4a was slightly greater than the predicted coverage. On occasion, the Bell 206 flew at an altitude somewhat above 100 ft during the overland portion of its flight because of buildings and other obstructions in the area. This would account for the increased range. No surveillance coverage was predicted from the SMI 268 ground station for this flight but there was a small amount of coverage just beyond the predicted coverage limit of 21 nmi. The agreement between the predicted and actual coverage for the EI 100 ground station was excellent, with the slightly greater range obtained as the helicopter flew toward EI 100 explained by the variations in the antenna pattern for the transponder. As was the case for the flight at 100-ft altitude to SMI 268, there is a coverage gap in the combined surveillance plot shown in Figure 5-4d.

5.1.3 Flights at 300-ft Altitude

Flights from the PHI heliport to each of the offshore ground station locations were also performed at 300-ft altitude. Again the helicopters hovered at landing pad level near each platform before returning to PHI. Figure 5-5 indicates the surveillance during the flights to SMI 268 and EI 100. These flights were performed on different days, but the results have been combined in the figure. The surveillance during both flights was excellent—throughout each flight, surveillance updates were received at a rate of once per 5 sec or better.

5.1.4 Flight at 2000-ft Altitude

One coverage flight with the Wiggins Bell 206 helicopter was performed at 2000-ft altitude. During this flight the helicopter flew from the PHI heliport to EI 100 and back. The combined surveillance coverage is shown in Figure 5-6. Again the surveillance performance was excellent with once per 5-sec updates received throughout the flight. Additional flights at 2000-ft altitude were flown to SMI 268 to assess possible effects of anomalous propagation, and these are described in the Appendix.

Prior to the testing, flights to each offshore platform at 5000 ft had been planned. However, because of the excellent results obtained during the flights at 300- and 2000-ft altitude, these additional flights were canceled since it was clear that they would also indicate continuous surveillance coverage.

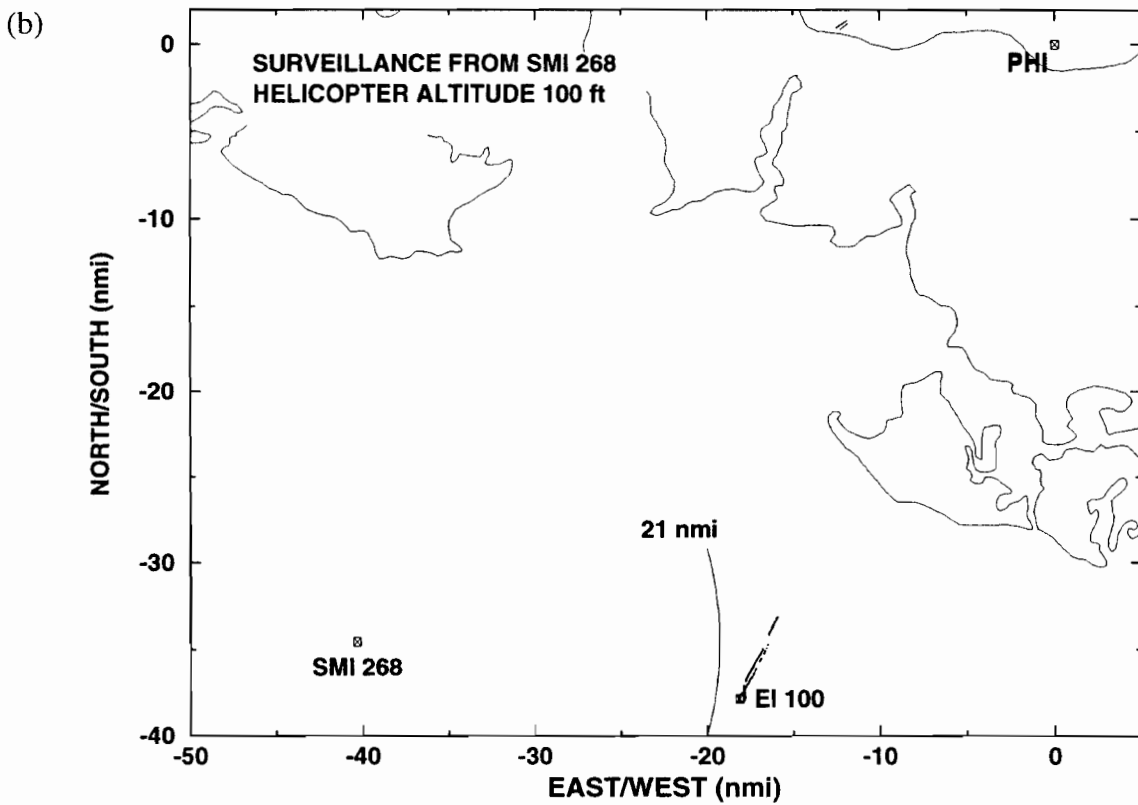
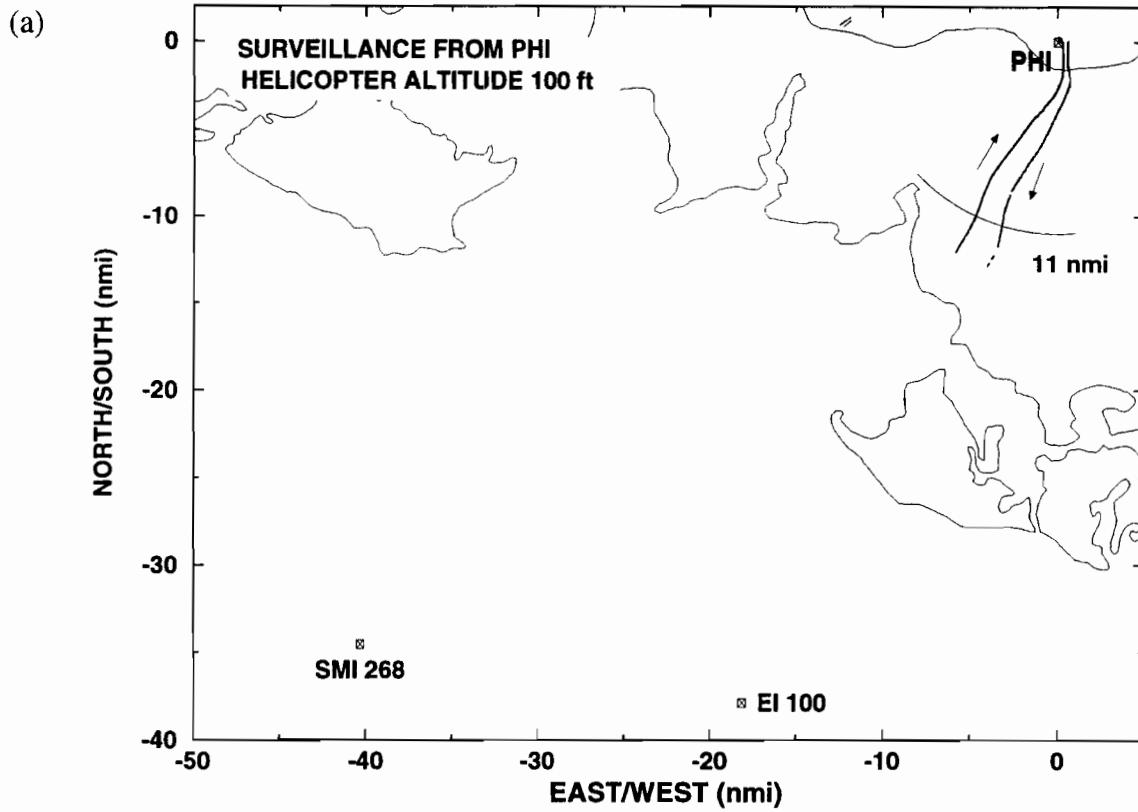

Figure 5-4a-b. GPS-Squitter surveillance of the Wiggins Bell 206, during a flight to EI 100 at 100-ft altitude, from the ground station at (a) PHI and (b) SMI 268.

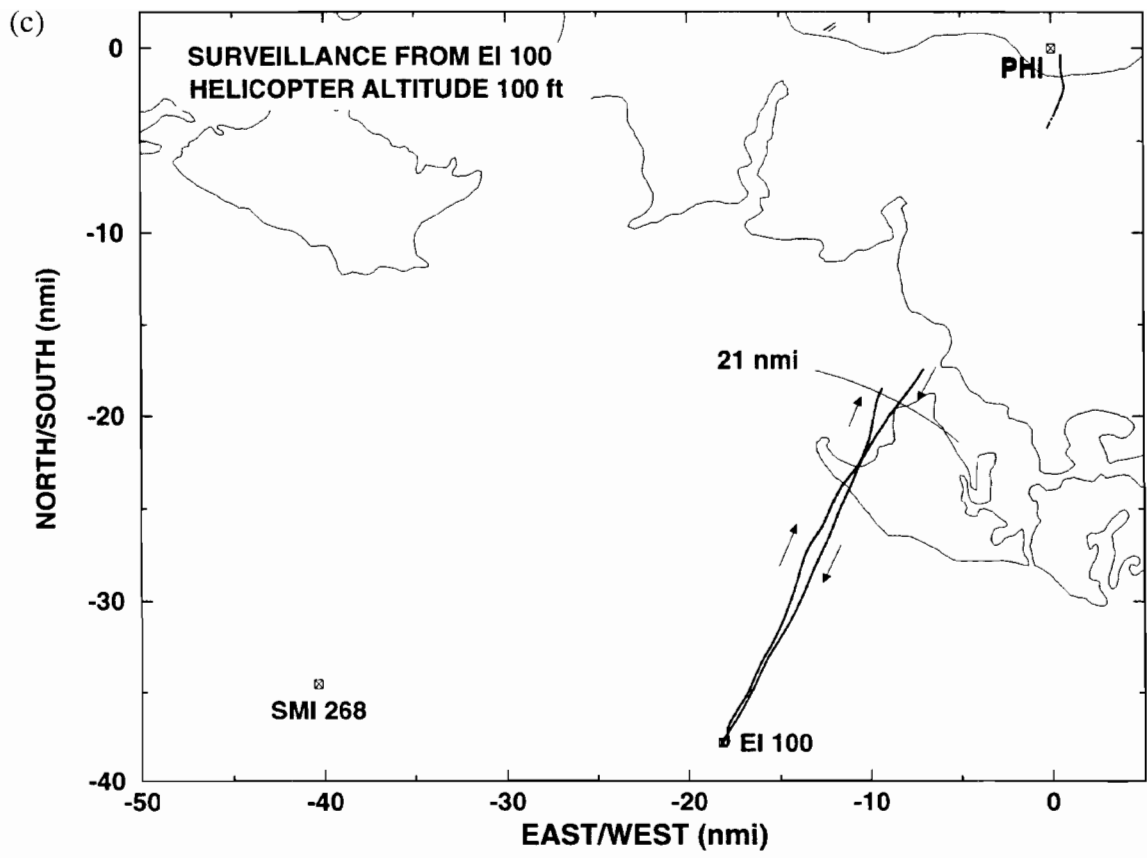

Figure 5-4c. GPS-Squitter surveillance of the Wiggins Bell 206, during a flight to EI 100 at 100-ft altitude, from the ground station at EI 100.

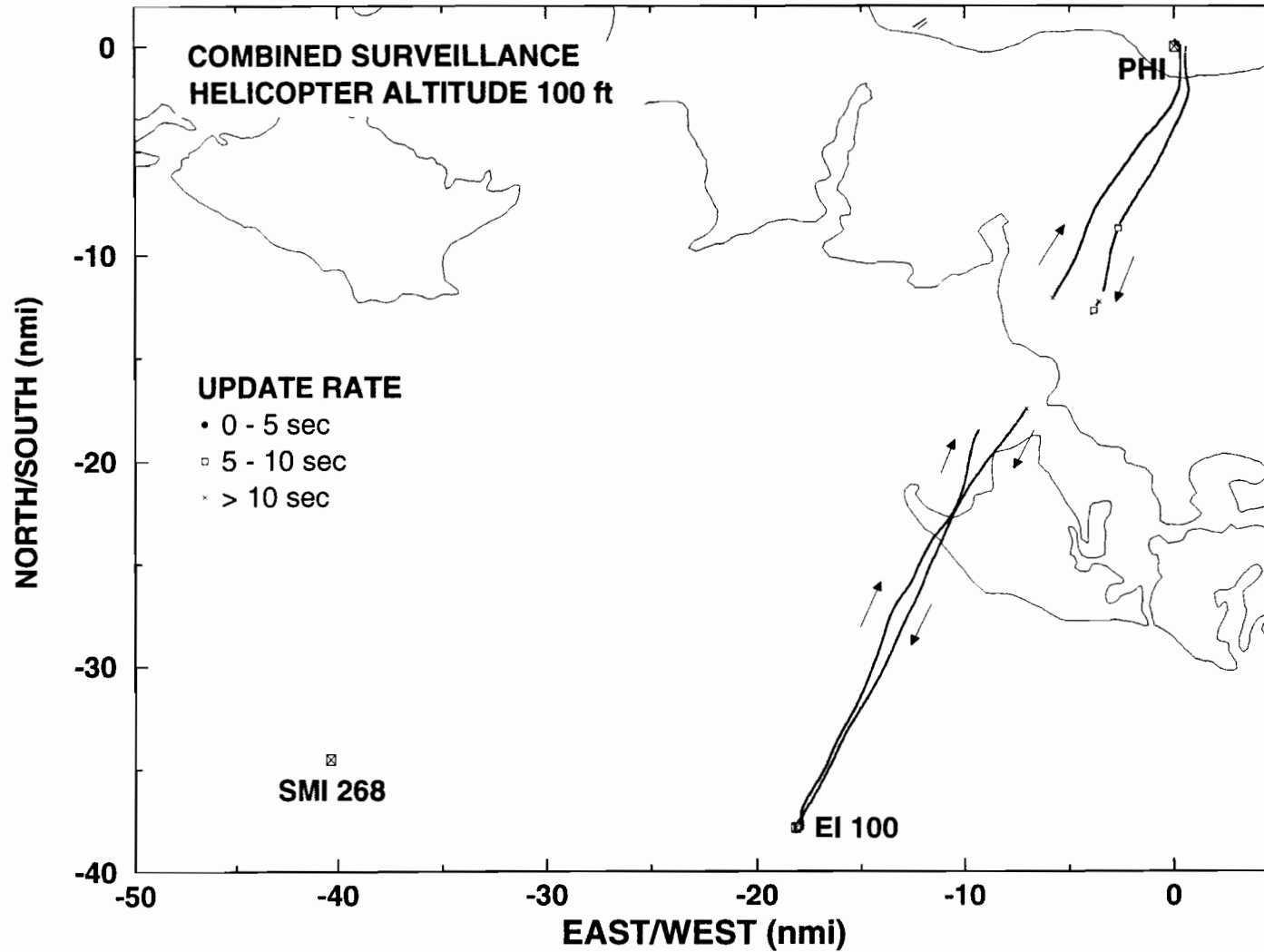

Figure 5-4d. GPS-Squitter surveillance of the Wiggins Bell 206, during a flight to EI 100 at 100-ft altitude, from the three ground stations combined.

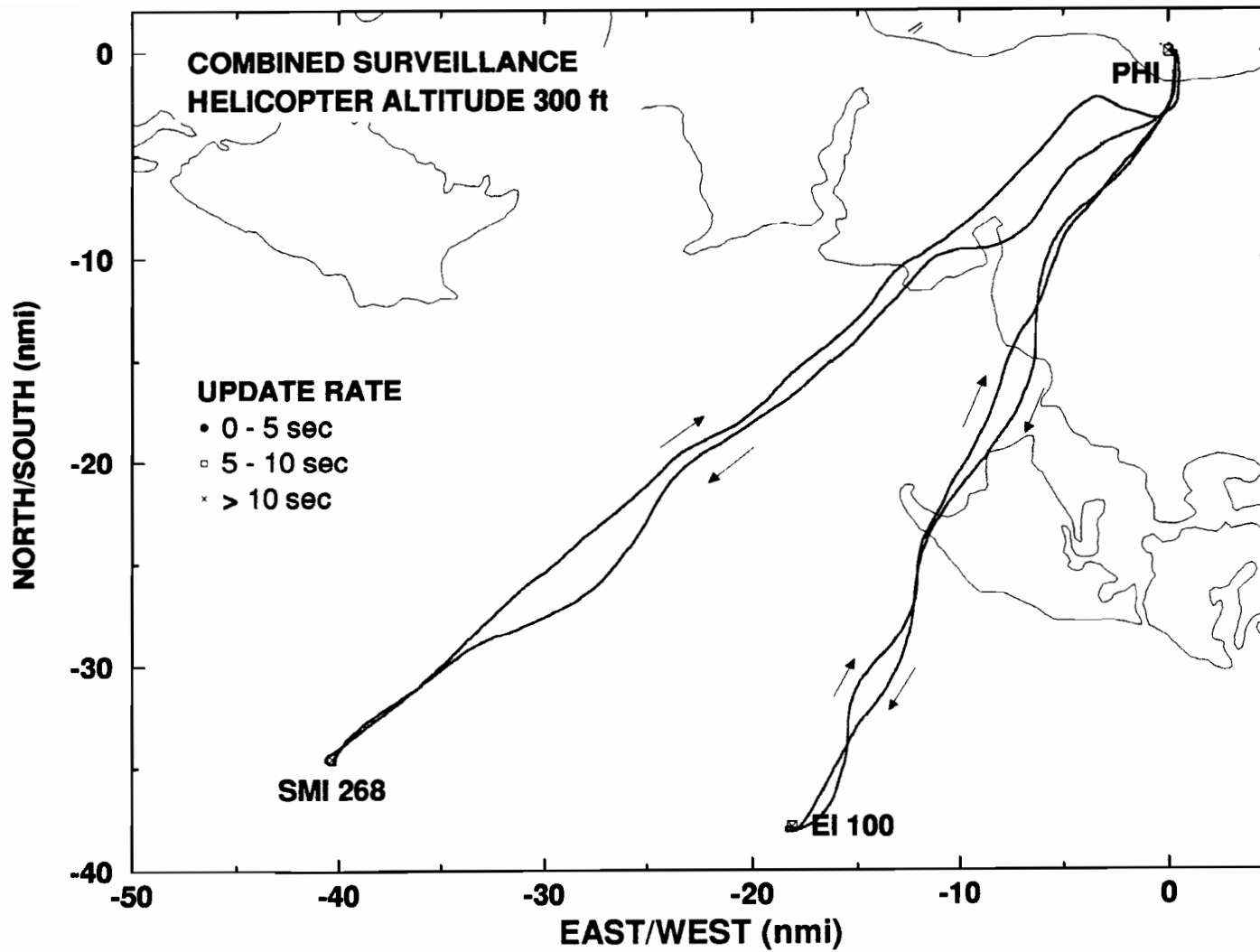

Figure 5-5. Combined GPS-Squitter surveillance of the Wiggins Bell 206 during flights to SMI 268 and EI 100 at 300-ft altitude.

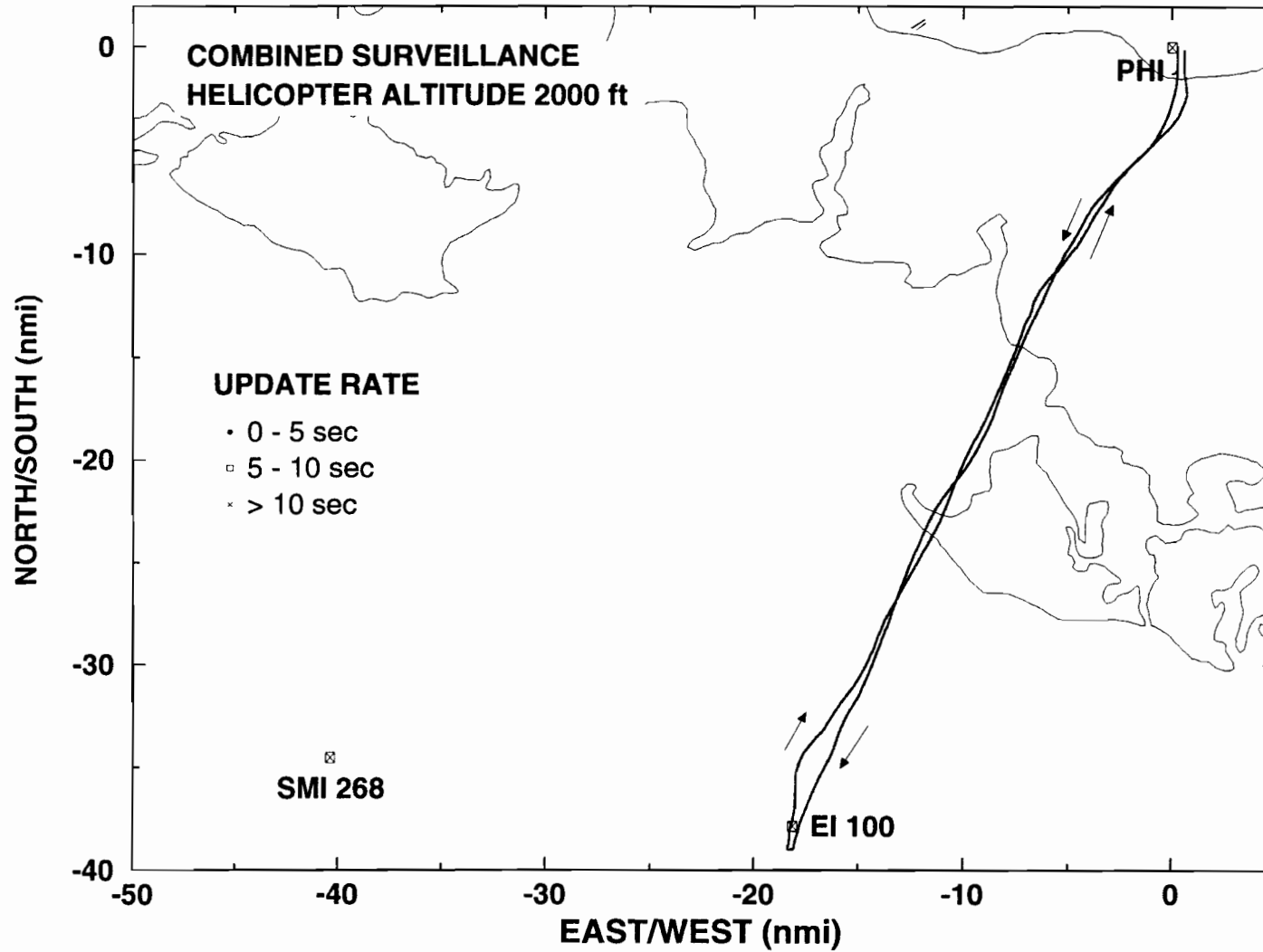

Figure 5-6. Combined GPS-Squitter surveillance of the Wiggins Bell 206 during flights to EI 100 at 2000-ft altitude.

5.2 PHI BELL 206 HELICOPTER

The second helicopter equipped with GPS-Squitter was an in-service helicopter operated by PHI. This PHI Bell 206 served as a target of opportunity during the testing. The PHI Bell 206 was based at the PHI heliport in Morgan City and was often within surveillance coverage of the GPS-Squitter ground stations.

An example of the surveillance coverage of the PHI Bell 206 is shown in Figure 5-7. When data recording was turned on that day, the PHI helicopter was airborne and approximately 10 nmi north of EI 100. The helicopter then flew toward the southwest to an oil platform beyond the surveillance coverage, returned to the Shell heliport near Morgan City, and then flew to a platform in Eugene Island Block 158 (EI 158) before returning again to the Shell heliport. While en route, the helicopter flew at altitudes of 500-700 ft.

Solid surveillance coverage of the PHI helicopter was achieved with the exception of when it flew south of the coverage area. The range at which surveillance was lost during this portion of the flight, 35-40 nmi, is consistent with the predicted range for a helicopter flying at 500-700 ft altitude. During the remainder of the flight, the surveillance update rate was once per 5 sec or better—including the period when the helicopter was on the landing pad at EI 158.

5.3 CESSNA 421 FIXED-WING AIRPLANE

Several flight tests were conducted with a Cessna 421 aircraft. Two of these were long range flights during which the Cessna flew toward the west—once at 20,000-ft altitude and once at 7500-ft altitude. The remaining flights with the Cessna followed various radials from the White Lake and Tibby VOR installations. The long range flights were designed to measure the high-altitude surveillance range of the ground stations over the Gulf. Flights along VOR radials measured the surveillance coverage for the flight paths followed during IFR conditions in the Gulf.

5.3.1 Long Range Flight at 20,000-ft Altitude

For the flight at 20,000-ft altitude, the Cessna 421 departed from Williams Memorial Field in Patterson, Louisiana, and flew to a point ~40 nmi west of the Sholes VOR in Galveston, Texas, before returning to Williams Field. Unlike the two helicopters which only have bottom-mounted transponder antennas, the Cessna is equipped with two antennas. One antenna is mounted on the bottom of the airframe and the other on top. Both antennas were enabled during the flight and the extended squitter transmissions alternated between the two antennas.

The surveillance coverage during the flight tests are shown in Figure 5-8. The four plots in this figure indicate coverage from each of the individual ground stations as well as the combined coverage. During the tests, the strength of the extended squitter transmissions was expected to vary based on range to a ground station and on the effects of ground bounce multipath. The latter is especially true for the two oil platform ground stations because, for each of these, the ground bounce was off the highly reflective Gulf water. Figure 4-3 shows the expected variation in received signal strength as a function of range for this case (an aircraft at 20,000-ft altitude).

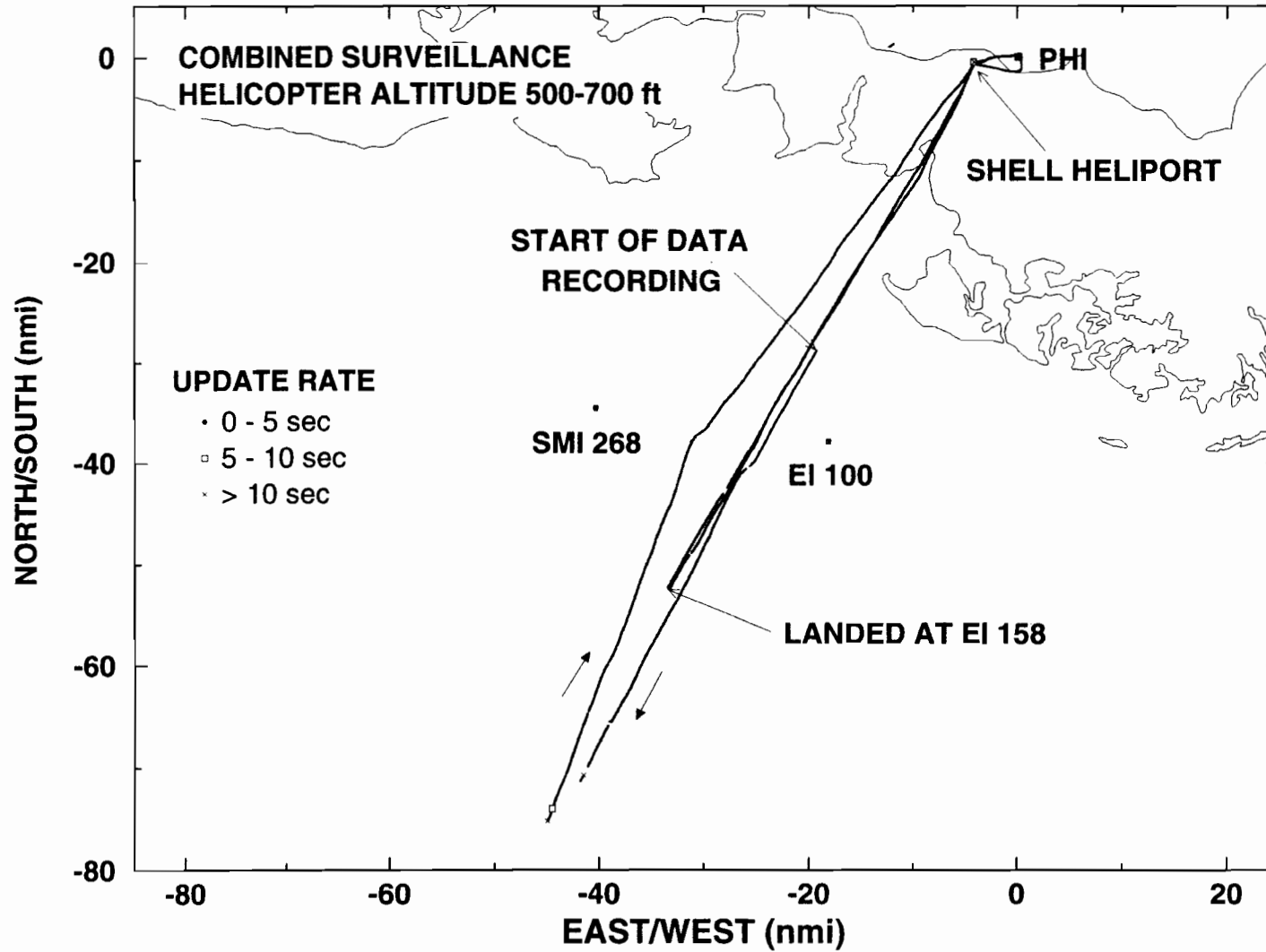

Figure 5-7. Combined GPS-Squitter surveillance of the PHI Bell 206.

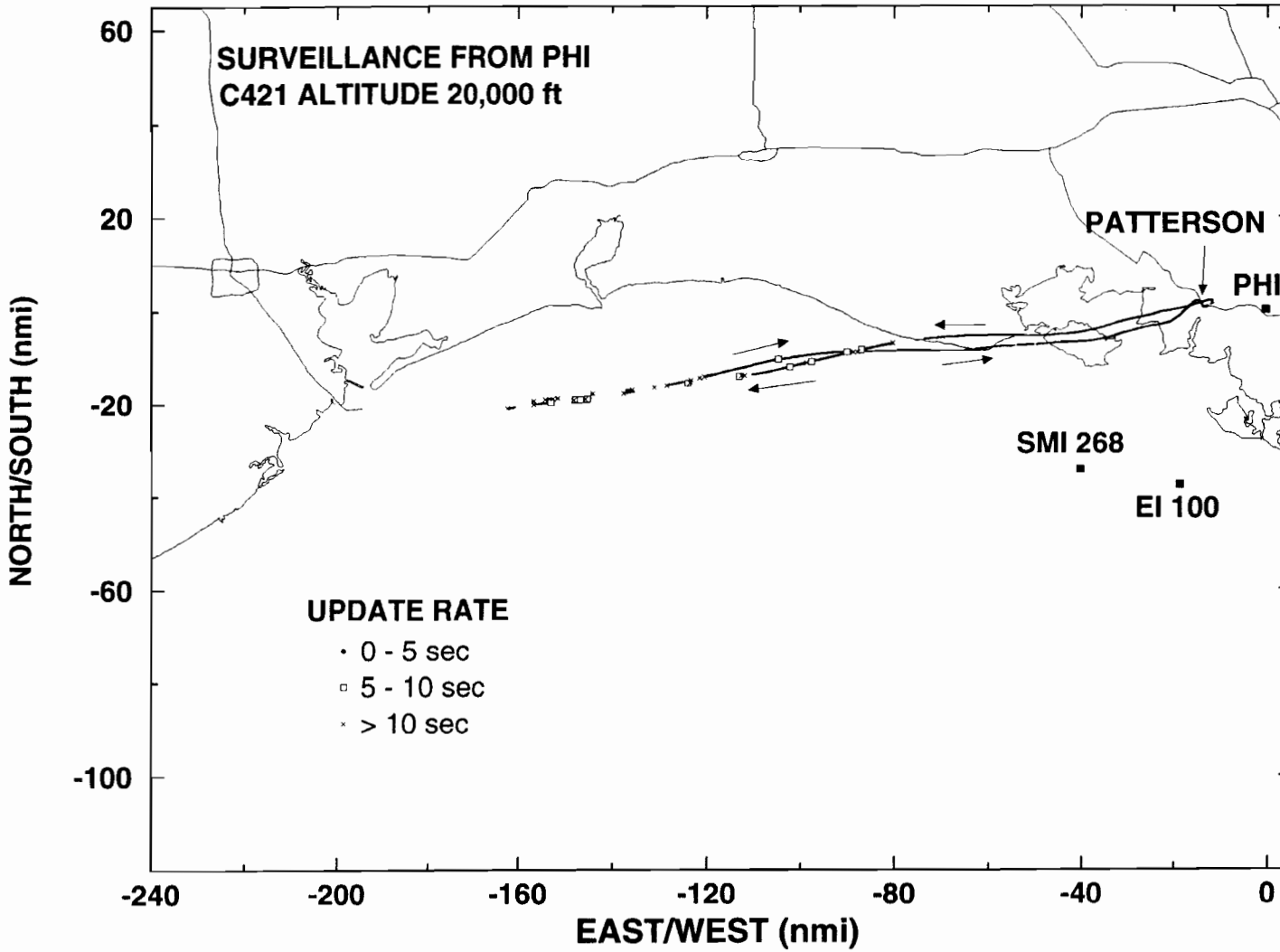

Figure 5-8a. GPS-Squitter surveillance of the Cessna 421, during a long range flight at 20,000-ft altitude, from the ground station at PHI.

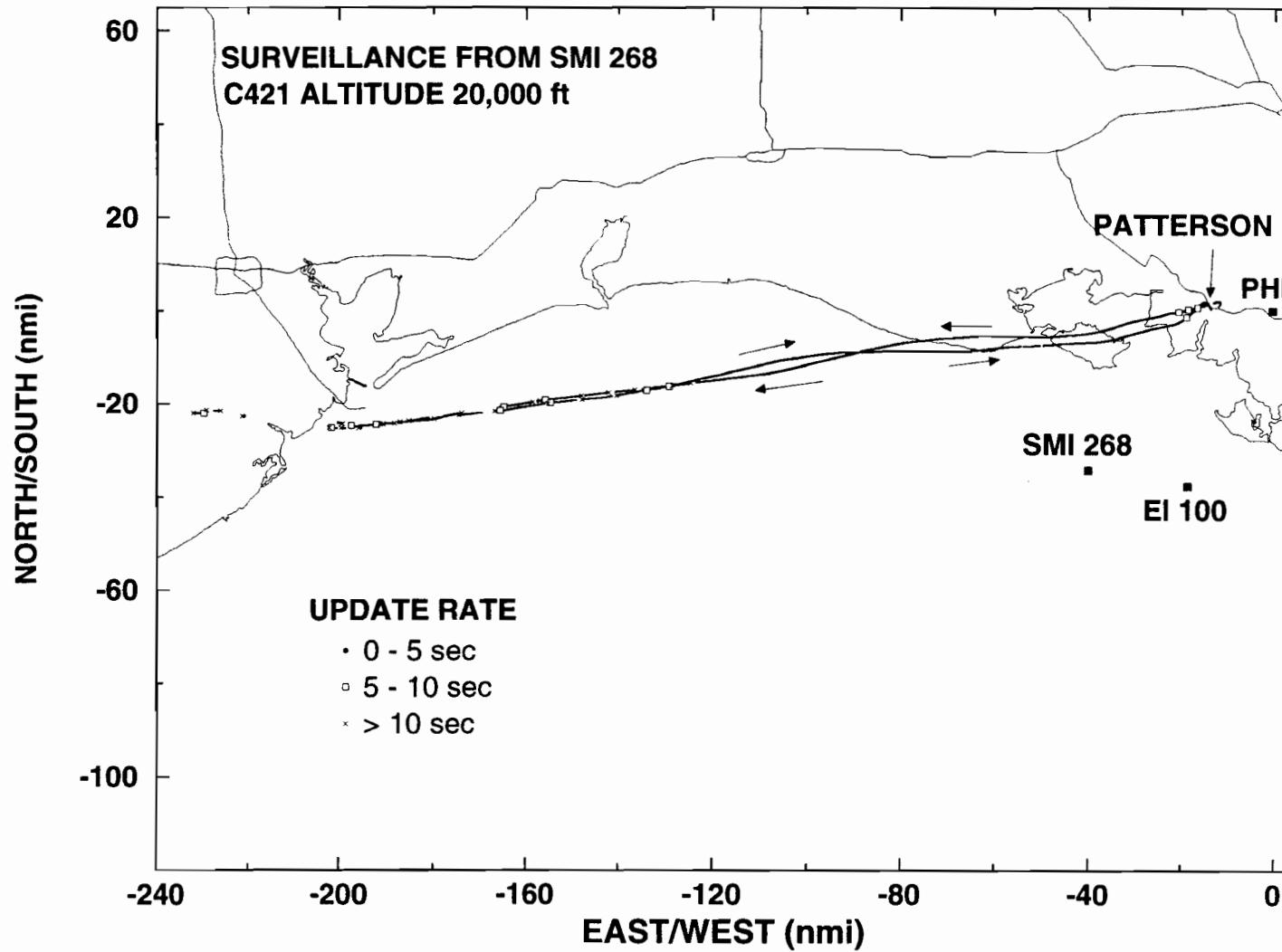

Figure 5-8b. GPS-Squitter surveillance of the Cessna 421, during a long range flight at 20,000-ft altitude, from the ground station at SMI 268.

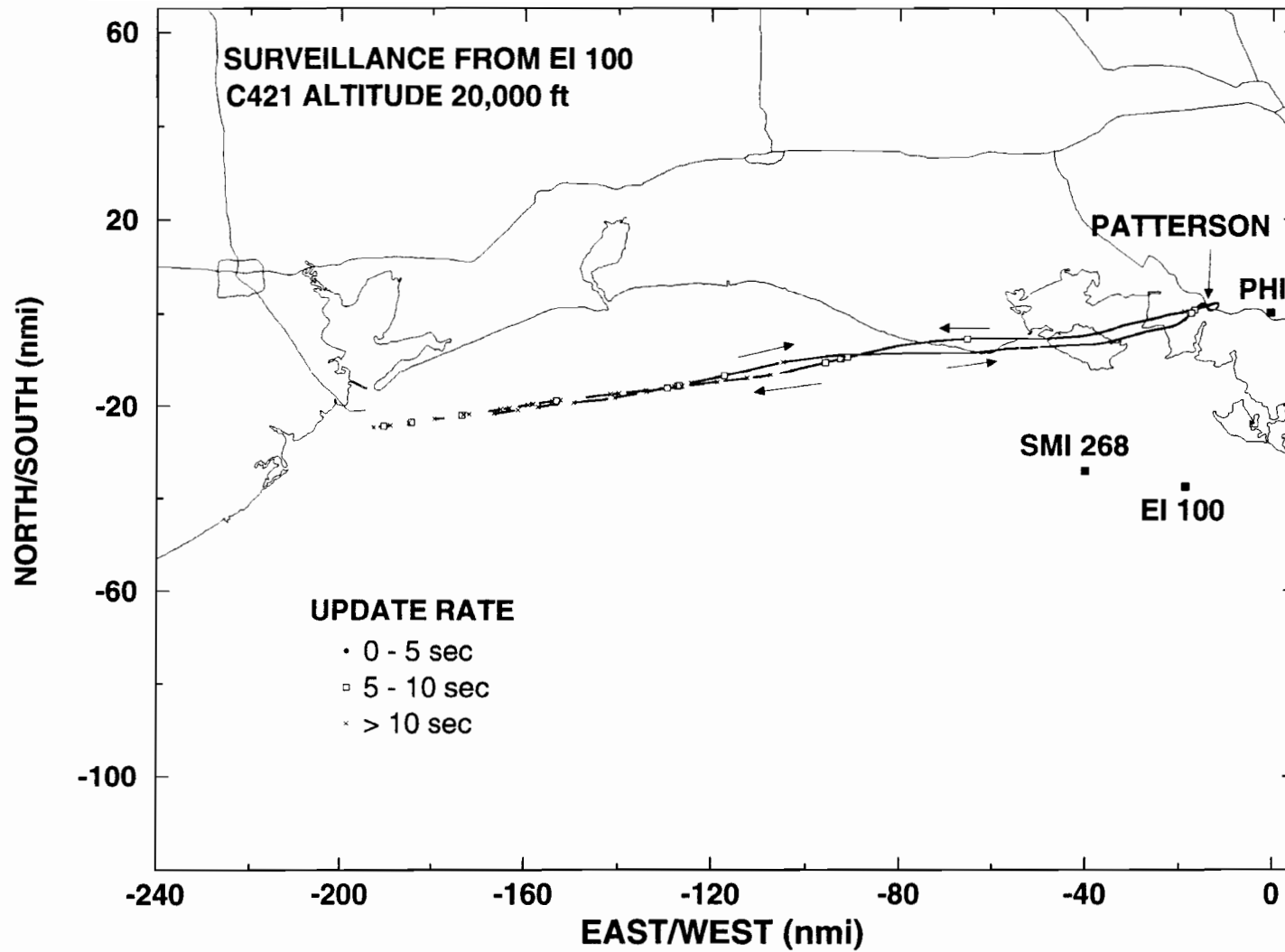

Figure 5-8c. GPS-Squitter surveillance of the Cessna 421, during a long range flight at 20,000-ft altitude, from the ground station at EI 100.

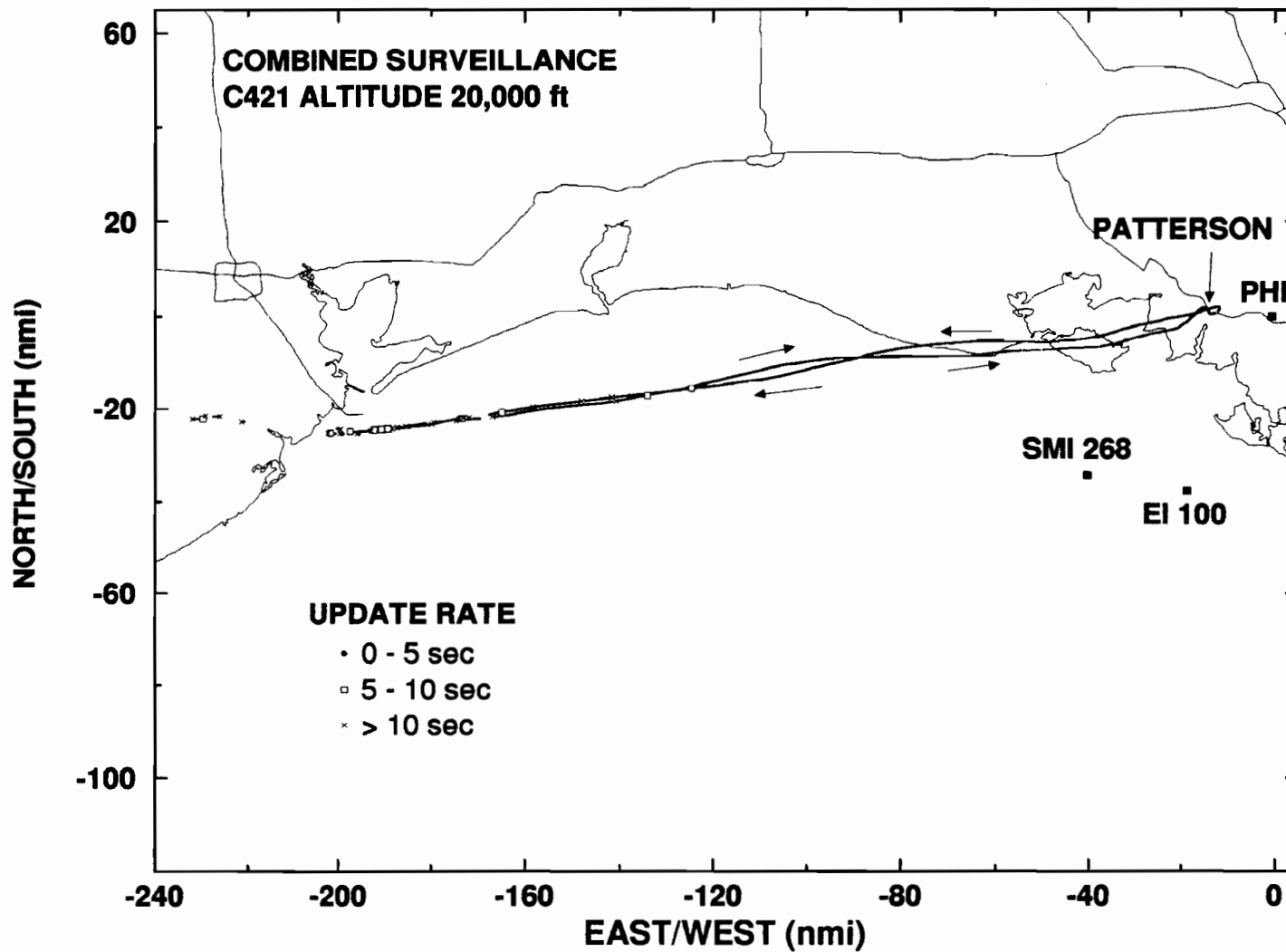

Figure 5-8d. GPS-Squitter surveillance of the Cessna 421, during a long range flight at 20,000-ft altitude, from the three ground stations combined.

The effects of ground bounce multipath are clearly visible in Figures 5-8b and 5-8c. Near the offshore ground stations, the link margin is sufficient to overcome the nulls caused by multipath reflections. However, at longer ranges there are gaps in the surveillance coverage and these gaps become wider with increasing range. The locations of multipath nulls do not agree exactly with Figure 4-3, but the overall pattern does agree. As expected, there is less evidence of multipath in Figure 5-8a which shows coverage from the PHI ground station (there are trees along the PHI path, which would tend to diffuse the reflected signal). The spatial diversity of the ground stations helped to fill in the coverage gaps for the individual ground stations as shown in combined coverage plot of Figure 5-8d.

Table 5-1 summarizes the surveillance update rate for the ground stations as a function of range. The probabilities of obtaining a surveillance update once every 5 sec and once every 10 sec are shown for each individual ground station and for the stations combined. Four cases are shown corresponding to ranges of 50, 75, 100, and 125 nmi from the individual ground stations. For the combined case, the range to the nearest ground station was used. Even though the Cessna remained at 20,000-ft altitude for most of the flight, it was below this altitude during its ascent from and descent to Williams Field. The results in Table 5-1 includes all altitudes above 3000 ft.

Table 5-1

Surveillance During Cessna 421 Flight at 20,000-ft Altitude

RANGE (nmi)	Probability of 5-sec Update				Probability of 10-sec Update			
	PHI	SMI 268	EI 100	Combined	PHI	SMI 268	EI 100	Combined
0-50	1.00	0.998	1.00	1.00	1.00	1.00	1.00	1.00
0-75	1.00	0.999	0.998	1.00	1.00	1.00	1.00	1.00
0-100	0.919	0.984	0.971	0.998	0.928	0.987	0.979	1.00
0-125	0.858	0.966	0.919	0.991	0.873	0.973	0.934	0.993

The surveillance to 75 nmi range was solid for all ground stations. A once-per-10-sec surveillance update (the typical en route update rate) was attained 100% of the time by each ground station out to this range. Beyond 75 nmi, the reliability started to taper off, but the combined performance was still 100% to 100 nmi range and 99.3% to 125 nmi.

5.3.2 Long Range Flight at 7500-ft Altitude

The long range flight at 7500-ft altitude followed a similar track to the one described above, i.e., the Cessna 421 departed from Williams Field and flew toward the Sholes VOR before returning to Williams Field. Figure 5-9 shows the coverage obtained during this flight for the individual ground stations as well as the combined coverage. Again the effects of ground bounce multipath are evident in the coverage plots for the two offshore ground stations (Figure 5-9b and 5-9c). Near the radar horizon of ~120 nmi, the coverage from the two platforms becomes intermittent before dropping off completely. As was the case in Figure 5-8d, the combined coverage plot of Figure 5-9d shows that the ground stations complemented each other quite well—few gaps in coverage occurred at the same time for all three stations.

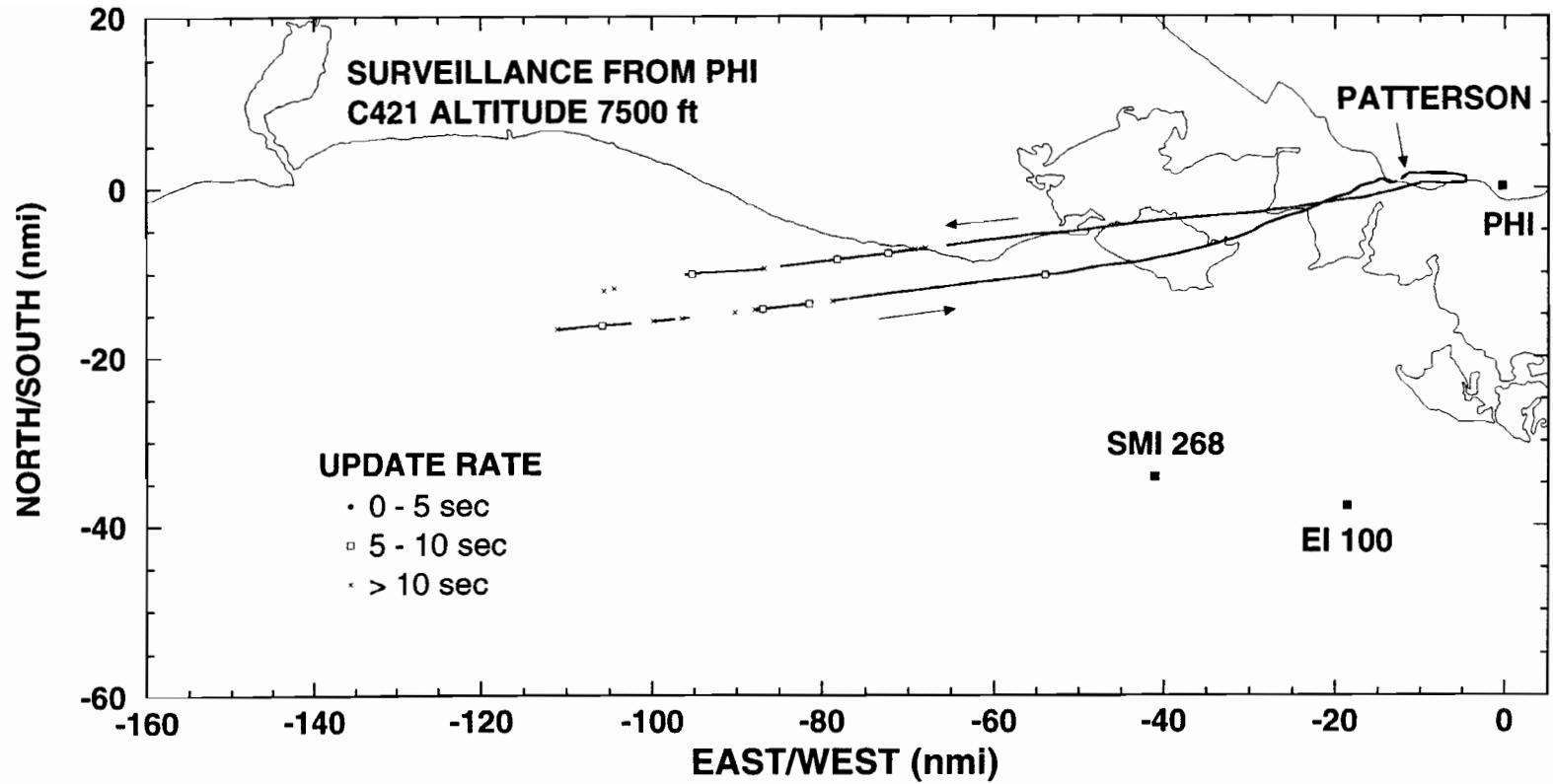

Figure 5-9a. GPS-Squitter surveillance of the Cessna 421, during a long range flight at 7500-ft altitude, from the ground station at PHI.

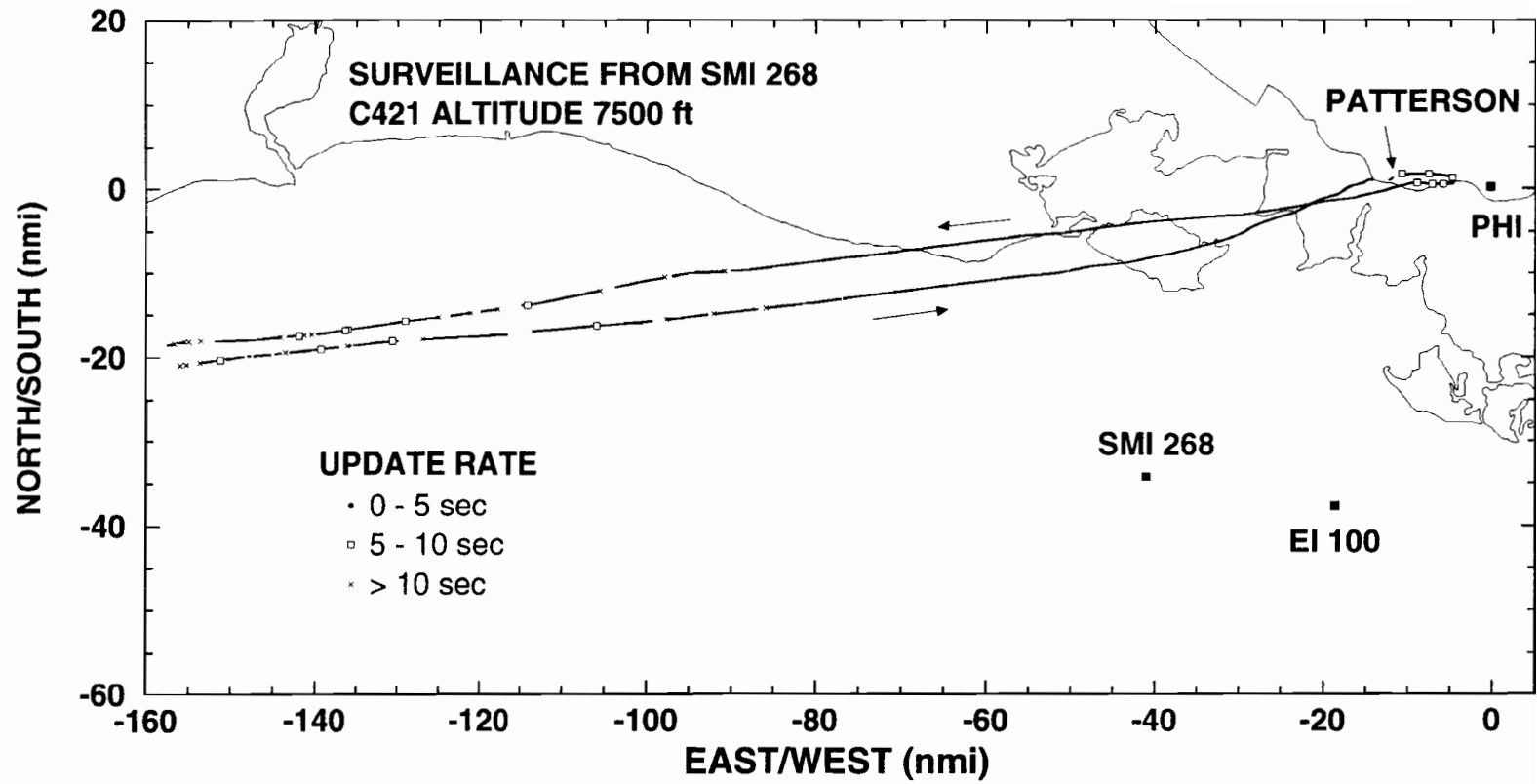

Figure 5-9b. GPS-Squitter surveillance of the Cessna 421, during a long range flight at 7500-ft altitude, from the ground station at SMI 268.

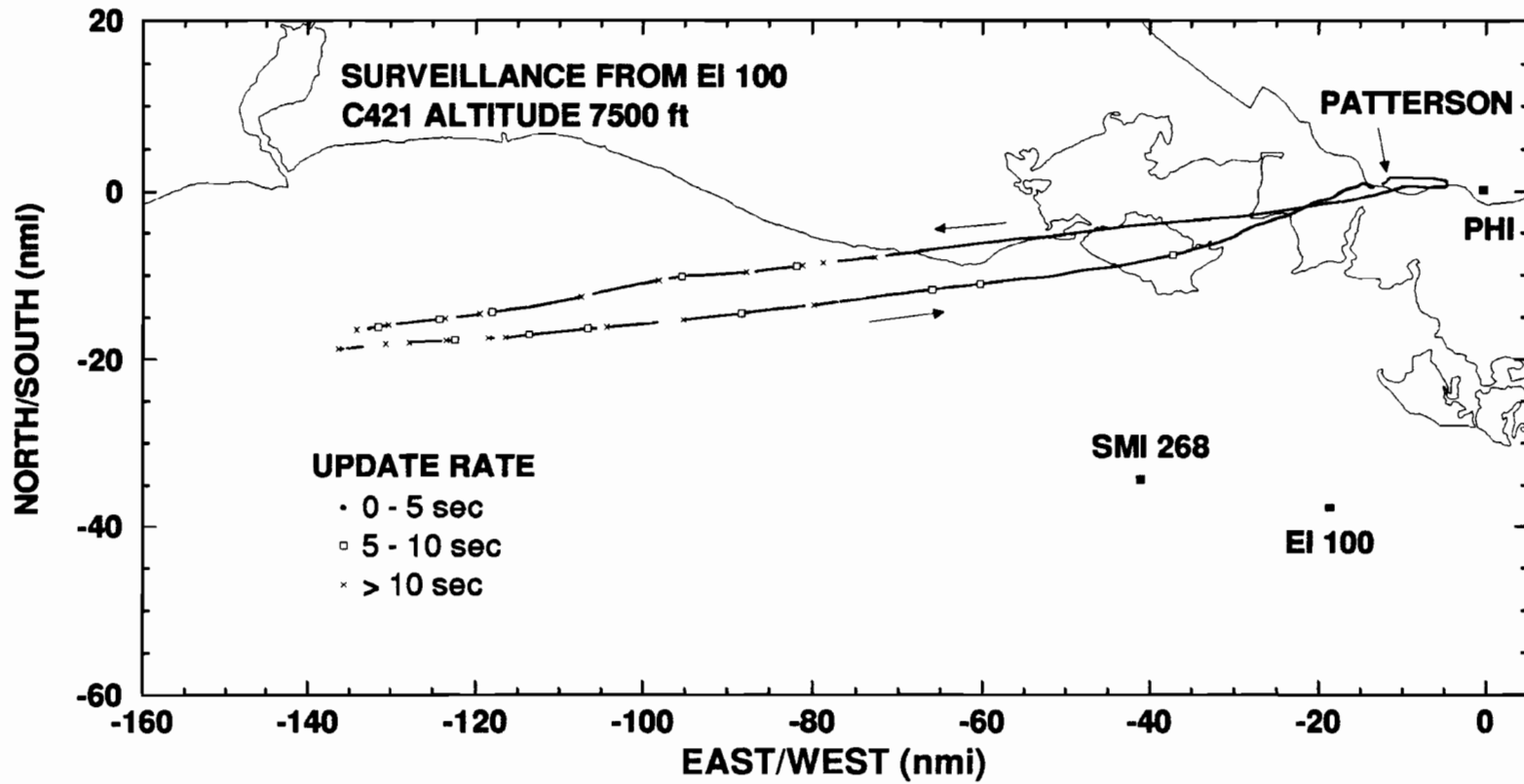

Figure 5-9c. GPS-Squitter surveillance of the Cessna 421, during a long range flight at 7500-ft altitude, from the ground station at EI 100.

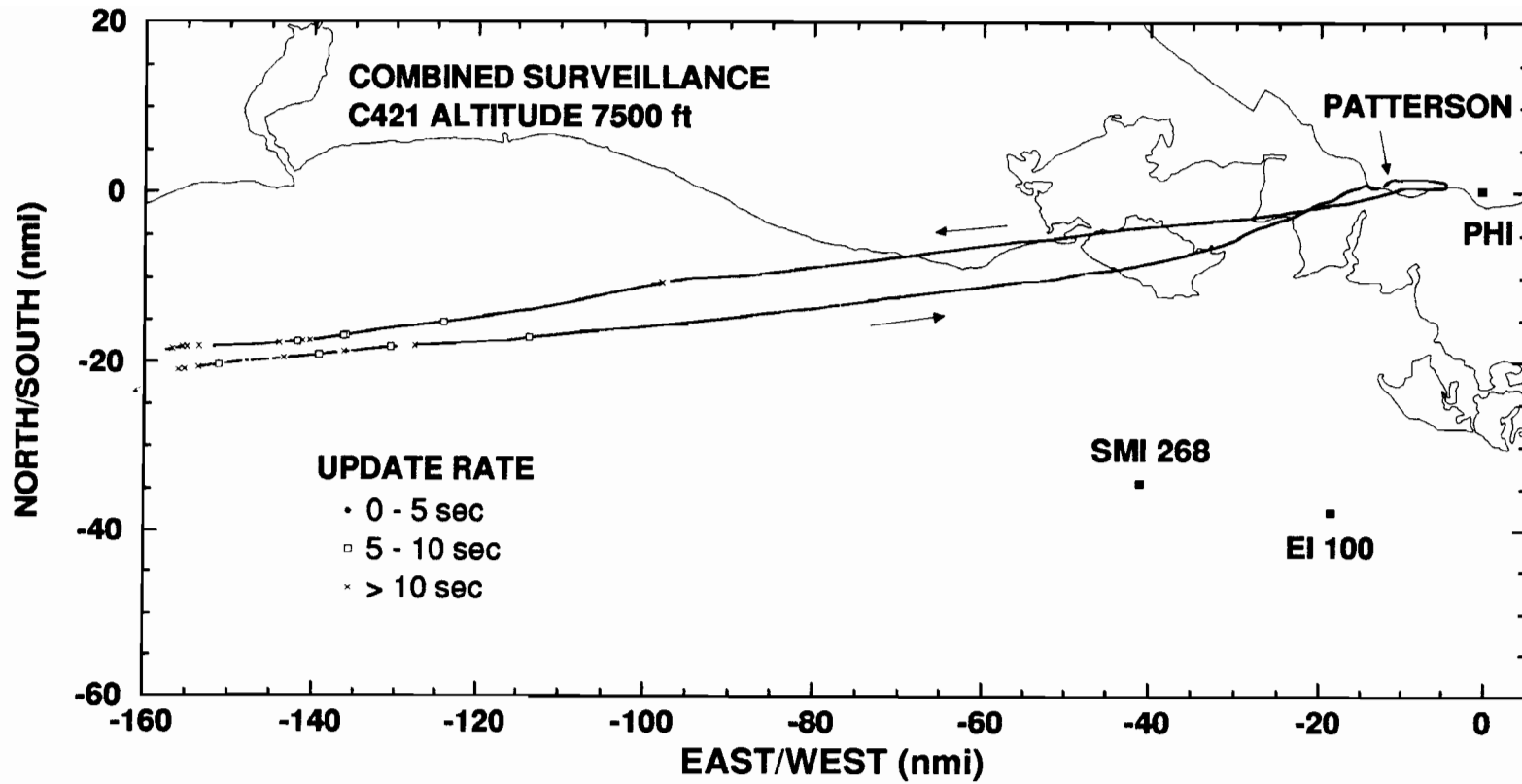

Figure 5-9d. GPS-Squitter surveillance of the Cessna 421, during a long range flight at 7500-ft altitude, from the three ground stations combined.

Table 5-2 summarizes the results for the 7500-ft altitude flight for ranges of 50, 75, and 100 nmi. The overall performance was, as predicted, less than that of the 20,000-ft flight, but still quite good. The combined surveillance provided a probability of a once-per-10-sec update of 100% to a range of 50 nmi and 99.5% to a range of 75 nmi from the nearest ground station. Out to 100 nmi the combined surveillance provided a 98.5% probability of a once-per-10-sec update even though the Cessna was beyond the radar horizon of the PHI and EI 100 ground stations for the outer portion of this case.

Table 5-2

Surveillance During Cessna 421 Flight at 7500-ft Altitude

RANGE (nmi)	Probability of 5-sec Update				Probability of 10-sec Update			
	PHI	SMI 268	EI 100	Combined	PHI	SMI 268	EI 100	Combined
0-50	1.00	0.994	0.997	1.00	1.00	1.00	1.00	1.00
0-75	0.969	0.960	0.945	0.995	0.974	0.971	0.958	0.995
0-100	0.897	0.913	0.919	0.980	0.909	0.929	0.936	0.985

5.3.3 Flights Along VOR Radials at 7500-ft Altitude

For several of the flight tests, the Cessna 421 followed routes typically taken by helicopters operating under IFR. During IFR, helicopters fly along VOR radials until they are near to the desired platform and then deviate from the radial to the platform (visibility permitting). The IFR flights may occur at altitudes up to ~7000 ft. An altitude of 7500 ft was chosen for the Cessna 421 as this was the minimum altitude that could be flown without interfering with regular helicopter operations in the Gulf. For added safety, all of the Cessna's flights were performed during VFR conditions.

Three different flights along VOR radials are depicted in Figure 5-10. In each case, the Cessna flew along a Tibby radial until it intercepted one of the White Lake radials and then followed the new radial toward the White Lake VOR. When the Cessna was ~10 nmi from White Lake it reversed course back to Tibby. Not surprisingly, the surveillance coverage was excellent within this region. With only a single exception, one or more surveillance updates were received from the Cessna every 5 sec during these flights. For the one exception, a surveillance update was received within 10 sec of the previous report.

5.4 COMPARISON OF PREDICTED AND MEASURED PERFORMANCE

Tables 5-3 and 5-4 compare estimated maximum ranges with measured maximum ranges for various aircraft altitudes. The first table applies to the PHI ground station; the second, to the platform stations. For the estimates, the maximum range is defined to be the greatest range at which the link margin is 4 dB. The agreement shown in the two tables between the estimated and measured maximum ranges is generally good. Even the 20,000-ft data for the platform ground stations are consistent with the propagation predictions; note that, according to Figure 4-3, the gaps between the link-margin peaks become smaller than the widths of the peaks only when the range is

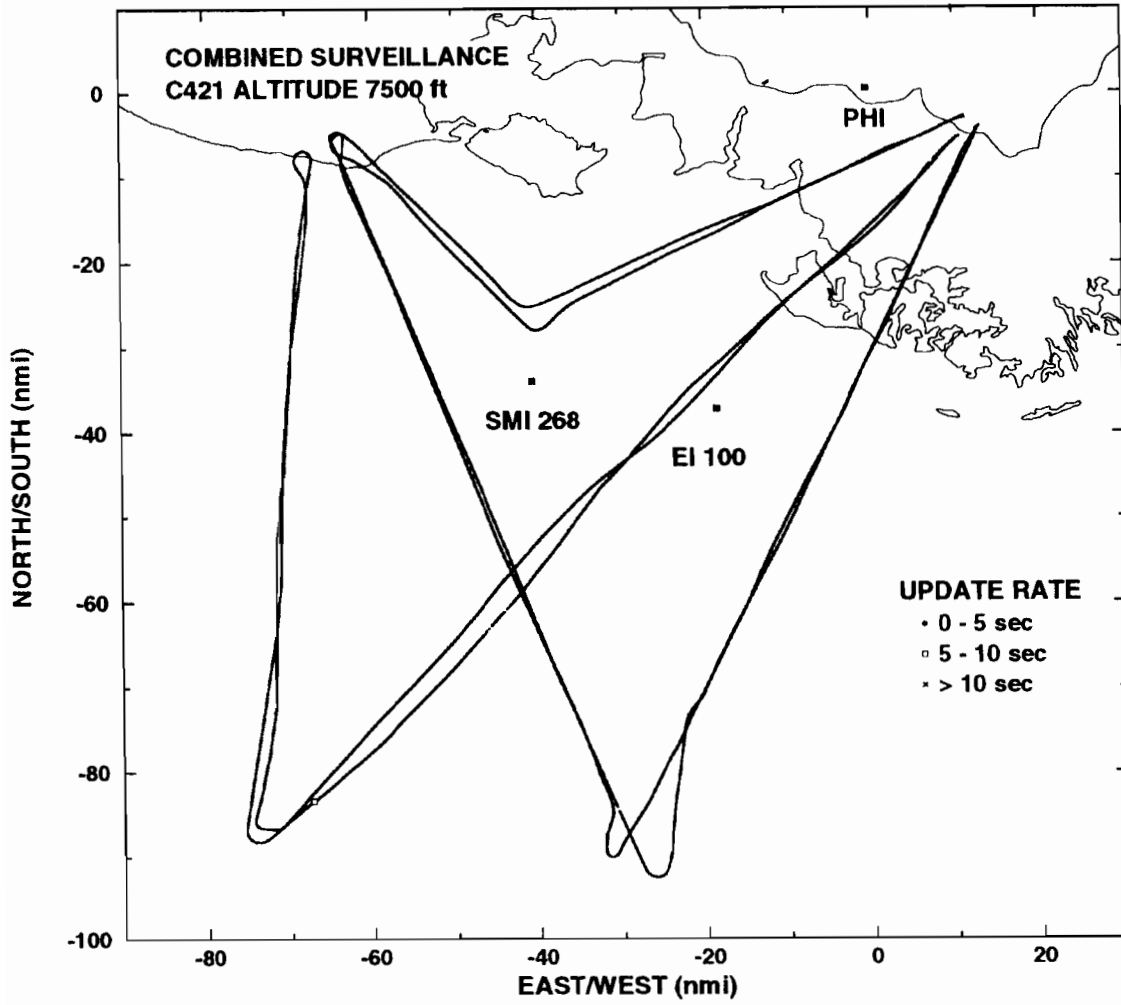

Figure 5-10. Combined GPS-Squitter surveillance of the Cessna 421 during flights along IFR routes at 7500-ft altitude.

smaller than about 90 nmi. To have the measured link performance described as intermittent at longer ranges than this is therefore to be expected.

The 20,000-ft data for all ground stations display another effect that distinguishes them from the lower-altitude data. At the higher aircraft altitudes, the maximum range is limited by system sensitivity rather than by horizon blockage. As a result, the general decrease in link margin down past the 4-dB threshold occurs more gradually. And since the threshold is in practice somewhat fuzzy, the intermittent link closure would be expected to extend over a wide range interval. This is consistent with the observed behavior, as shown in Tables 5-3 and 5-4.

Table 5-3

Estimated and Measured Maximum Range from PHI Ground Station

Aircraft altitude (ft)	Estimated maximum range (nmi)	Measured maximum range (nmi)
100	11	12 solid; 15 intermittent
300	20	21 solid; 23 intermittent
20,000	100	111 solid; 165 intermittent

Table 5-4

Estimated and Measured Maximum Range from Platform Ground Stations

Aircraft altitude (ft)	Maximum range (nmi)		
	Estimated	Measured at EI 100	Measured at SMI 268
100	21	22 solid, 27 inter.	20 solid, 25 inter.
20,000	136	108 solid, 174 inter.	117 solid; 162 inter.

6. POSSIBLE OPERATIONAL SYSTEM

The measured performance of GPS-Squitter described in Section 5 combined with the good agreement between predicted and measured coverage make it possible to outline an operational system for surveillance in the Gulf of Mexico. A possible operational system is presented in this section that would provide surveillance and data link services in the offshore region containing the oil platforms for all aircraft at 300-ft altitude and higher.

The basic components of this proposed operational system are as follows. Ten ground stations would be located at existing onshore towers that vary in height from 500 to 1050 feet; antenna heights are assumed to be 50 feet below the tower tops. Standard telephone lines would be used for communication between these stations and a central control computer. Thirteen ground stations would be located on offshore oil platforms which currently have satcom links to shore, and these links would provide the necessary ground-station-to-central-computer communication for the offshore stations. Antenna heights for the offshore stations are assumed to be 160 feet. The surveillance coverage that such a system would provide for aircraft at 300-ft altitude is presented in Figure 6-1.

Coverage from these ground stations would be essentially limited by line of sight. The offshore stations would provide a surveillance range of 30 nmi for aircraft at 300-ft altitude. The radius of coverage for the onshore stations varies with tower height and ranges from 42 to 53 nmi in Figure 6-1. With this siting of stations, there would be contiguous single-station coverage over the entire oil platform region, with some overlapping coverage. For aircraft at higher altitudes, there would be a greater amount of overlapping coverage. For aircraft at lower altitudes, there would be gaps in the coverage.

Commercial DME omnidirectional antennas are planned for the offshore stations. These antennas would be located on the very tops of the towers on the oil platforms, so as to have an unobstructed view 360 degrees in azimuth. Such offshore stations will have a signal-to-noise-limited range of 100 nmi for air carrier aircraft, assuming that the aircraft are high enough to have line of sight to the receiving antennas. They will have a line-of-sight limited range for helicopters and general aviation aircraft; e.g., 30 nmi for helicopters at 300-ft altitude.

For onshore stations, commercial DME antennas could also be used, providing that the antennas can be mounted on the very tops of existing towers. If they must be mounted some distance below the tops, a multiple aperture wrap-around design will be necessary in order to provide omnidirectional azimuth coverage in the presence of a tower.

Figure 6-2 indicates the necessary and optional equipment for offshore region equipage. Ground station antenna and backlink (communication between ground stations and a central control computer) design has been discussed above. The ground interrogator receiver units could be operational versions of the GIRUs used for the November - December 1994 testing. The principal upgrades needed for this are:

- Integration of the local SUN computer functionality into the TCAS (or equivalent) unit,
- Operation from standard 110 volt AC power,
- Addition of a GPS clock to mark time of squitter reception,
- Addition of a remote maintenance monitoring function.

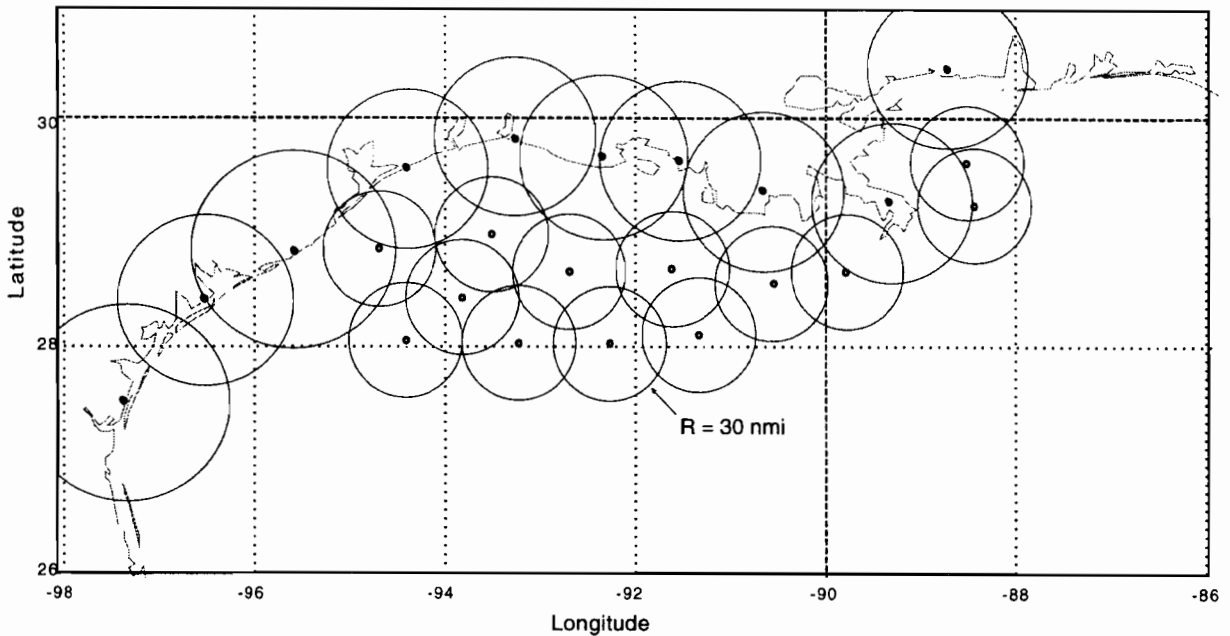

Figure 6-1. Predicted coverage of an offshore region operational system having 10 ground stations on shore towers and 13 ground stations on oil platforms, for aircraft at 300-ft altitude.

Surveillance data can be provided to as many locations as required. Some of these will probably be the FAA Houston ARTCC, the FAA New Orleans TRACON, FAA flight service stations, NORAD, U.S. Customs, U.S. Coast guard, Gulf helicopter operators, and Gulf oil companies. All of these can be equipped with displays for surveillance of aircraft, and either one-way or two-way Mode S data link for communication with pilots. Standard land line communications are adequate for connecting the central control computer with all of these remote locations.

Proposed avionics for the equipage of rotary wing and fixed wing aircraft flying in the offshore region is shown in the lower right part of Figure 6-2. The essential components, necessary for GPS-Squitter surveillance, are: (1) a source of position information such as GPS¹, (2) a pressure altitude digital encoder, and (3) a GPS-Squitter capable Mode S transponder². An appropriate GPS receiver on board could also provide the pilot with instrument approach capability to both oil platform helipads and on shore heliports, when such approaches are approved by the FAA.

An optional component, necessary for uplink of weather information and two-way data link operation, is some type of control and display unit (CDU). This could vary from a simple liquid crystal text display to a full high-resolution color display.

¹ GPS without differential correction, which provides position accuracy to 100 m or better 95% of the time [11], is adequate for en route surveillance of aircraft in the region.

² Under contract to Lincoln Laboratory, AlliedSignal has developed a General Aviation version of a GPS-Squitter capable level 3 transponder which is expected to sell for less than \$3000.

Optional components, necessary for cockpit display of traffic information (CDTI) are: (1) a 1090 MHz squitter receiver, and (2) a CDU. These permit an aircraft to receive and display position and identification squitters from nearby aircraft, thereby providing the pilot with a local air traffic display.

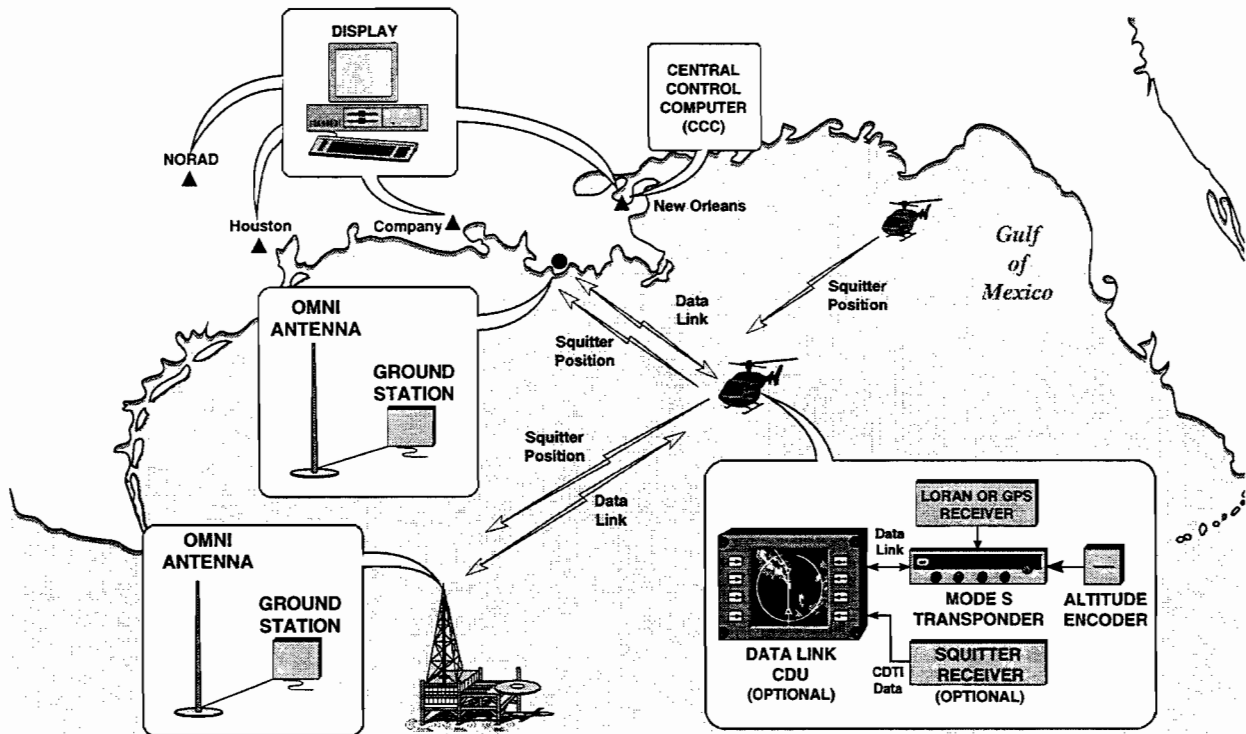

Figure 6-2. Equipment for an offshore region operational system providing both ADS-B surveillance and two-way data link.

7. SUMMARY

During November - December 1994, numerous GPS-Squitter flight tests were conducted in the Gulf of Mexico. Three aircraft participated in these tests—two Bell 206 helicopters and a Cessna 421 fixed-wing airplane. The extended squitter messages emitted by these aircraft were received by two GPS-Squitter ground stations on oil platforms and a third located onshore. The helicopters flew at altitudes varying from 100 ft to 2000 ft and the Cessna flew at 7500 ft and 20,000 ft.

The helicopter testing demonstrated that continuous surveillance of helicopters flying at 300-ft altitude and above could be achieved with ground stations located ~50 nmi apart. A grid of stations could be installed in the Gulf utilizing oil platforms that already have satcom links back to shore plus some shore-based platforms. To provide surveillance on aircraft at altitudes of 300 ft and above, approximately 23 ground stations, 10 on shore, 13 on platforms, would be needed to service the entire region where oil platforms are located.

The long range flights with the Cessna 421 provided a measure of the surveillance range of the GPS-Squitter ground stations. The ground stations on oil platforms with standard DME antennas provided good surveillance to a range of 100 nmi. Good agreement was found between the measured surveillance coverage and the predicted coverage.

During the flight testing, live traffic displays were available at the New Orleans TRACON, the Houston ARTCC, and the PHI heliport in Morgan City. These displays indicated the position of the test aircraft on a background map of the Gulf region. Associated with each aircraft was a data tag that provided the identification (tail number) of the aircraft, its altitude and ground speed. Controllers and representatives from helicopter operators were invited to view the live traffic displays. Although no quantitative evaluation was conducted, the overall reaction was very positive.

In summary, the flight testing in the Gulf of Mexico indicated that GPS-Squitter is a practical and effective near-term option for providing accurate and real-time air surveillance for both high-altitude air traffic in the Gulf and low-altitude traffic in the offshore region serviced by oil platform helicopters.

APPENDIX A. PROPAGATION TESTING

A1.0 INTRODUCTION

Two days of the flight testing were devoted to exploring propagation phenomena. This testing addressed, first, the question of how well the coverage predictions matched the coverage measurements, and second, the threat to the system posed by anomalous propagation. The results have already been described in detail in a Project Memorandum [12]. The following is a summary of this work.

On each of these two days, December 7 and 8, a helicopter made two round-trip flights at a constant 2000-ft altitude from the helicopter base to the SMI 268 platform. All three ground stations recorded the long squitters broadcast by the helicopter's transponder. One of each day's flights was made at mid-morning, when propagation conditions were most likely to be good, and one at sunrise, when anomalous propagation is reported by Houston Center to be prevalent. (Its effect is seen by the primary ARSR radars as an increase in clutter.) On the second day, to increase the vulnerability of the system to propagation-induced reductions in link margin, and thereby enhance the data signature of propagation effects, the sensitivity of each ground station was reduced by 6 dB.

Achieving a distinct data signature of propagation effects was also the reason for choosing an altitude of 2000 ft. At that altitude, the propagation model described in Section 4 predicts that several well spaced multipath nulls will occur within the range interval flown by the helicopter (see Figure 4-1). At a lower altitude, only one or two nulls would occur, and so could be indistinguishable in the data from signal loss due to other effects such as heading dependent variations of the helicopter antenna gain (see Figure 4-2). At greater altitudes, the nulls would become numerous and closely spaced, which could cause them to overlap one with the next and so not be distinct (see Figure 4-3).

However, it was clear that a two-day snapshot would be insufficient to sample adequately the long term propagation statistics. Therefore, a review was made of the way propagation considerations are incorporated into the design and operation of microwave relay links, for which a mature industry with a very substantial body of experience and techniques has evolved over the years. The propagation issues of GPS-Squitter surveillance are very similar.

A2.0 RESULTS

Figure A-1 is a map of the test area in the Gulf of Mexico. The flight path of one of the four round trip flights, as measured by the GPS-Squitter ground stations, is shown, as well as the locations of the three ground stations. The other three flights followed essentially the same path.

The long squitters were broadcast by the helicopter at a rate of one each half second and were recorded by the ground stations as they were received. A gap in the record occurred whenever the received signal strength at a ground station was too small for the squitter to be recognized and decoded. Since in practice each ground station steadily receives the vast majority of the squitters transmitted within its coverage area, the significant data consist of the incidence of missed squitters rather than the incidence of received squitters. Accordingly, the data were plotted in the form of the cumulative missed squitter count as a function of range from the ground station.

In the vicinity of a range at which a multipath null occurs, one would expect to see the curve climb more steeply to reflect the fact that more squitters will be missed when the signal level is low.

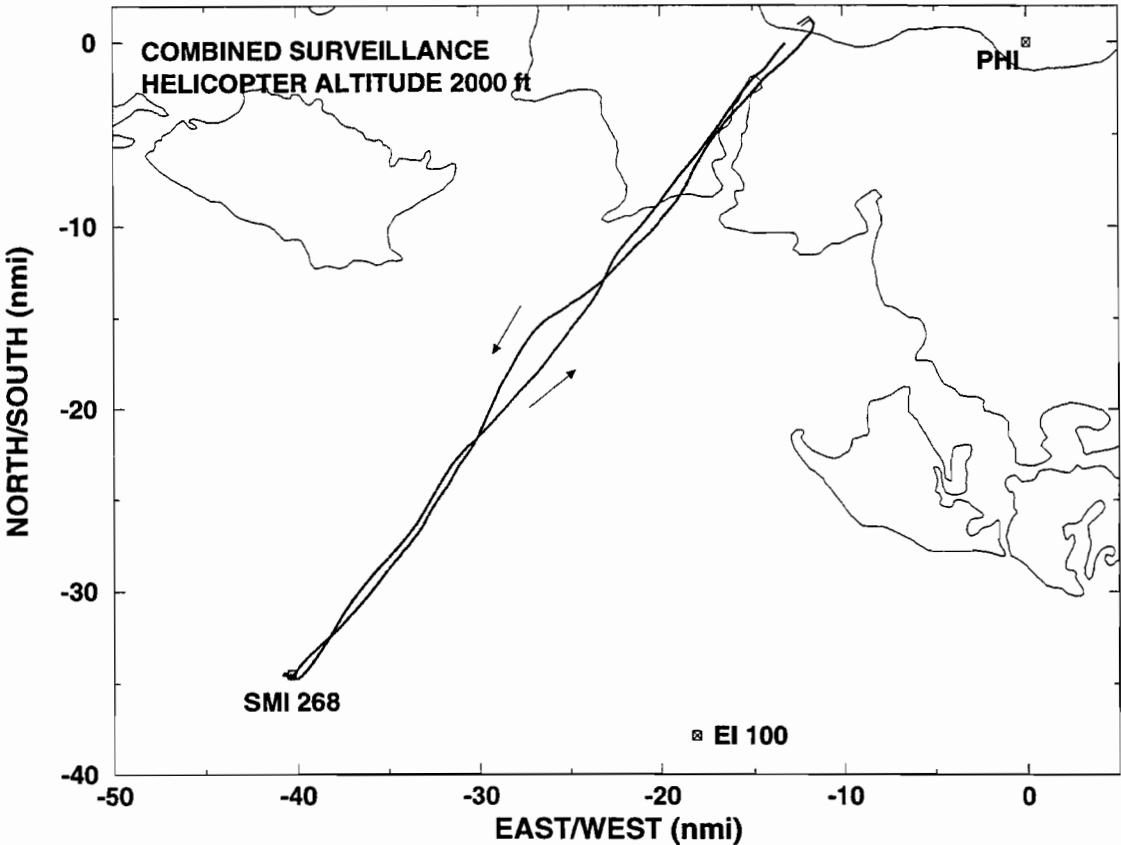

Figure A-1. Flight path taken by Wiggins Bell 206 helicopter during propagation testing.

Figure A-2, which presents the data gathered during one leg of one of the four flights, confirms this expectation. The curve displays small steps in the predicted vicinity of the multipath nulls, denoted by arrows. The periodicity of the steps matches that of the arrows, even though the alignment is not perfect.

One reason the alignment cannot be expected to be perfect is that the location of the multipath nulls is sensitive to aircraft altitude, and since this altitude deviates, one would expect to see a corresponding deviation of the nulls from their nominal positions. Another reason is the likelihood that the refractive index of the atmosphere is not everywhere equal to that of the standard atmosphere, but deviates from point to point. This too would cause the null positions to shift.

The same flight leg is also shown in Figure A-3. This time the data were collected by the PHI ground station. Here there is no evidence of any pattern of multipath nulls, in agreement with the 'absorbing treetop' propagation model plotted for this ground station in Figure 4-1. Since in this figure the direction of flight was toward the ground station, the cumulative missed squitter count increases as the range decreases, giving the curve a negative slope.

Figure A-4 shows the result at the SMI 268 ground station of repeating the flight leg which produced the data in Figure A-2, but with the system sensitivity reduced by 6 dB. The reduced sensitivity, compounded by low aircraft antenna gain in the direction of this ground station, caused a drastic increase in the missed squitter rate, and enhanced the data signature of the multipath nulls.

In contrast, for this same flight leg, the data collected at the PHI ground station show hardly any effect from the reduced sensitivity (see Figure A-5). That is because the aircraft antenna gain is relatively high in the forward direction, and so the 6 dB reduction in sensitivity did not affect the system as strongly as it did the SMI 268 ground station.

The four graphs in Figures A-2 through A-5 were selected from the total of 24 prepared from the four round-trip flights. They illustrate typical results. What is shown, in summary, is that the data are completely consistent with the simple multipath propagation model for the platform ground stations and with the simple absorbing treetop model for the land-based ground station. The different results obtained under different conditions were all consistent with the assumption that the atmospheric refraction is stable and can be accounted for by the simple device of making the effective earth radius four-thirds the actual one. In particular, the data collected at sunrise show no evidence of anomalous propagation.

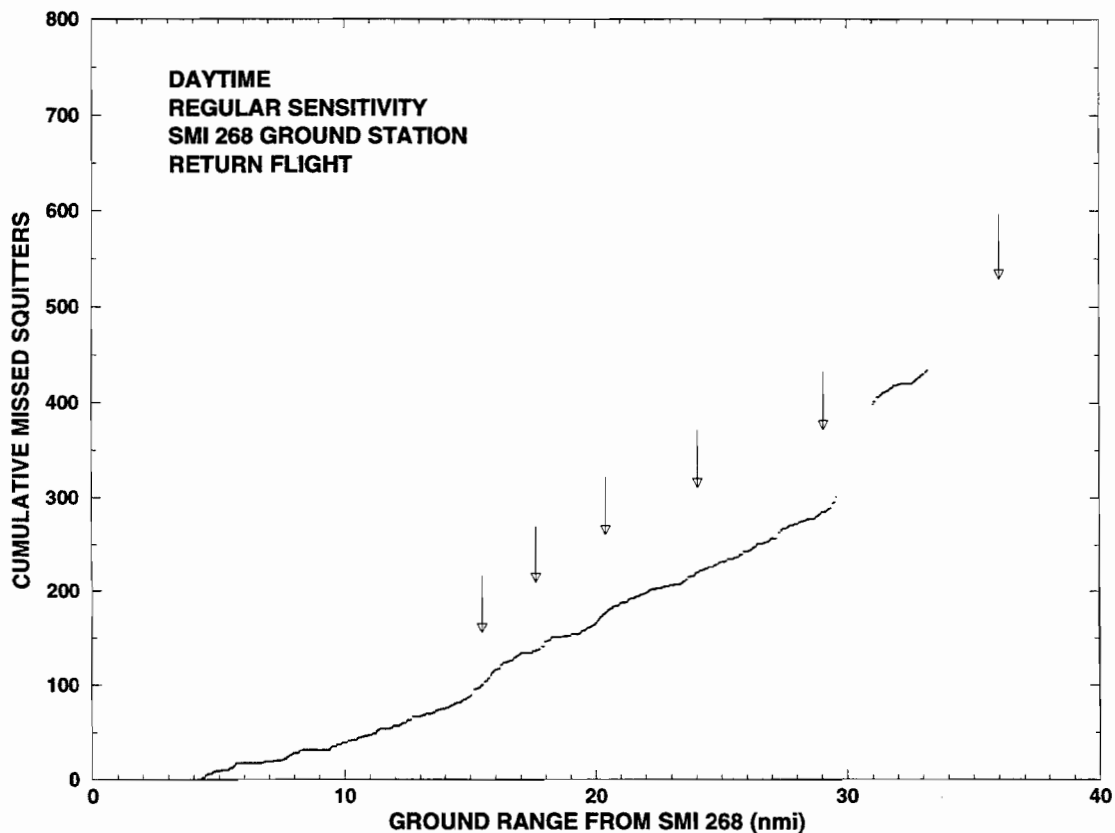

Figure A-2. The cumulative missed squitter count for the ground station at SMI 268 during the return leg of the daytime flight that used normal system sensitivity. This flight was used to establish the baseline data record. The arrows show the predicted positions of the multipath nulls.

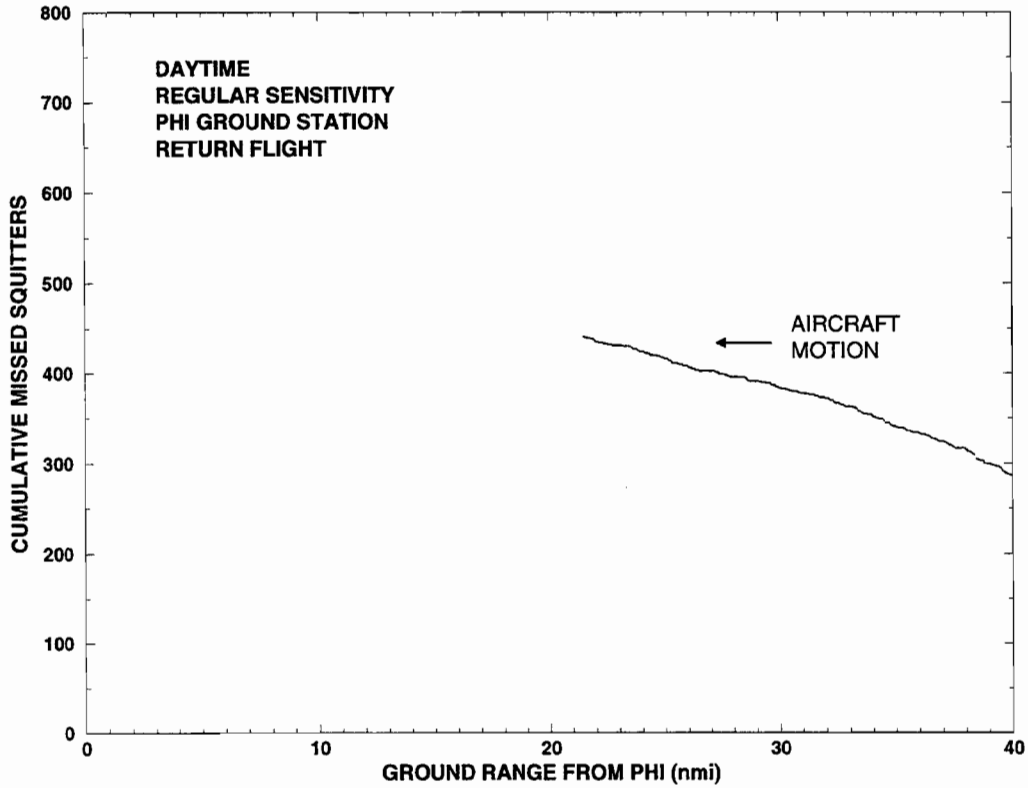

Figure A-3. The cumulative missed squitter count for the PHI ground station during the same return flight leg as Figure A-2.

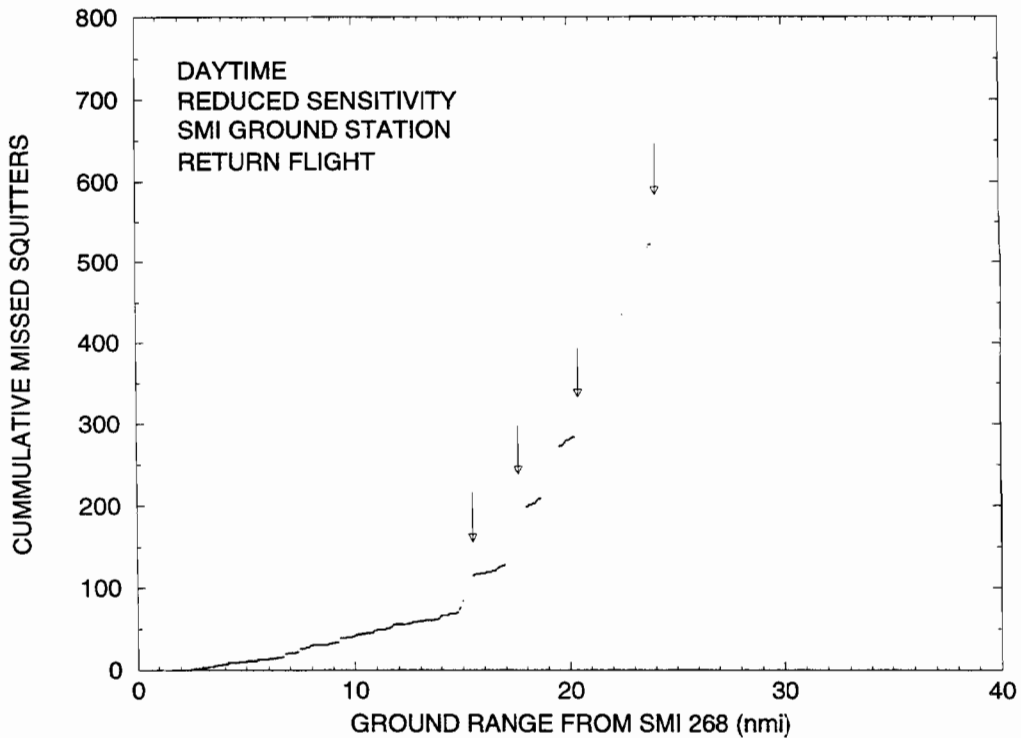

Figure A-4. The cumulative missed squitter count for the SMI 268 ground station during the return flight leg of the daytime flight in which the system sensitivity was reduced by 6 dB.

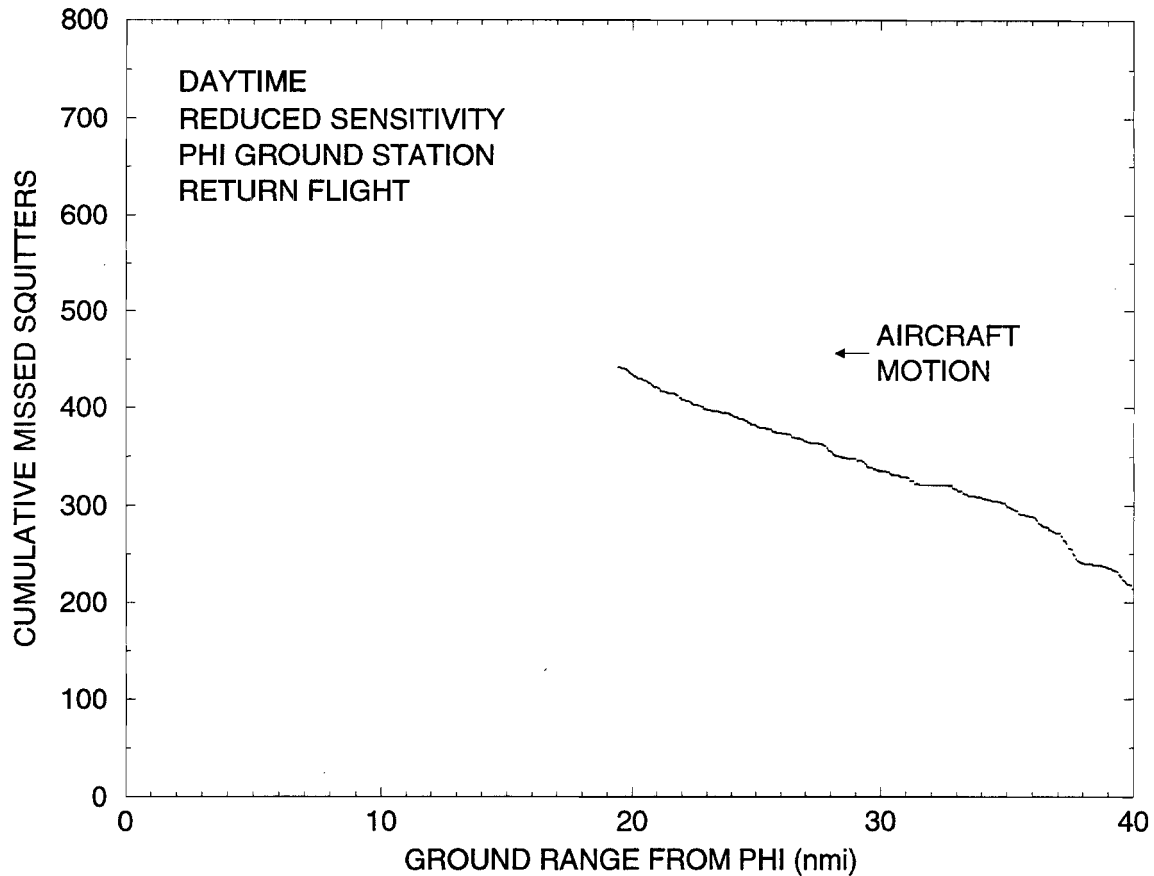

Figure A-5. The cumulative missed squitter count for the PHI ground station during the same return flight leg as Figure A-4.

Further supporting these conclusions are the coverage range data collected at various aircraft altitudes on days other than the two devoted specifically to propagation testing. They compare favorably with the estimates of maximum range made using the simple propagation model, as the tables in Section 5.4 show.

A3.0 ARSR EXPERIENCE AT HOUSTON CENTER

The results of the two days of propagation tests, while useful, are not enough to support the conclusion that anomalous propagation is never a problem. In the first place, for propagation analysis, the data were limited in the sense that there were no measurements of signal strength, only the single bit of information signaling the success or failure of a squitter reception. In addition, for this weather-driven statistically-varying situation, our sample was small. And finally, throughout the two days of tests, the weather was benign. How well the system would operate long term is a question still left to be answered.

This question is particularly pertinent to operation near the coastline of the Gulf of Mexico. Propagation anomalies are due to variations of the atmosphere's refractive index, which is a function of the temperature, pressure and, especially, humidity. The anomalies are more likely in warm climates than in cold ones because warm air can hold more water vapor than cold air [13]. Moreover, propagation anomalies are more likely at coastlines than over the open ocean or inland

far from the ocean. That is because the temperature and humidity differences between air over the land and air over the water can lead to inversions and atmospheric ducts when the wind pushes cool dry air under warm humid air.

Fortunately, in place along the Gulf coast, there already exists a closely related aircraft surveillance system that has been in continuous operation for many years. It is the FAA's system of five ARSRs reporting to Houston Center. All have a secondary surveillance beacon radar that receives at the same frequency as GPS-Squitter. If a serious problem with propagation exists, the operators of these radars would know about it.

When asked about their experience with anomalous propagation, the operators make a clear distinction between the beacon radar and the primary radar. They report that, day in and day out, year round, the beacon radar functions reliably. They see no negative effects of anomalous propagation. The only effect they notice at all is the positive one of being able occasionally to track aircraft that are geometrically well over the horizon, an effect caused by atmospheric ducting. The primary radar, on the other hand, is often blinded by clutter when changing atmospheric conditions cause the clutter to appear to move and, therefore, gets through the clutter filter. Clutter is not a problem for the beacon radar because its return signal is at a different frequency from its transmitted signal.

GPS-Squitter, which operates at the same frequency and with the same signal format as the beacon radar downlink, and which has, in its pure surveillance mode, no uplink, can be expected therefore to be as little affected by anomalous propagation as are the beacon radars.

The conclusion to be drawn from this is that since the beacon radars are successful, GPS-Squitter will likely be successful, too. The uncertainty then reduces to that of establishing the appropriate values of the system parameters, such as link margin, coverage range or altitude. For that, we can get some guidance from the accumulated experience over the years with designing and operating microwave relay links.

A4.0 EXPERIENCE WITH MICROWAVE RELAY LINKS

The usual assumption made in estimating signal trajectories at low elevation angles is that the earth's radius is four thirds the true earth radius. That assumption was made in preparing the coverage curves shown in Figures 4-1 through 4-3.

In reality, the atmosphere seldom conforms to this simple model. Temporal and spatial variations in refractivity due to pressure, temperature and humidity keep it constantly changing. It is said that anomalous propagation is typical.

If the refractive index gradient is different from the standard one, the ray paths curve more or less than the standard amount. More curving is described as super-refraction. This is not a problem. Its most noticeable effect is to allow communication between terminals far enough apart that the standard model would predict them to be out of communication range.

The problem comes when, due to sub-refraction, the ray paths curve more upward. Then communication is denied between terminals close enough to be normally within radio line of sight. The ray path connecting the two terminals is driven down far enough to intersect the earth's surface and therefore become blocked by it. Sustained sub refraction fades of several tens of decibels have been recorded on links with insufficient clearance [14].

The way to mitigate this problem is to ensure that, in a standard atmosphere, the clearance between the ground and the ray path is large enough to guarantee that the most extreme sub-refraction likely to be experienced locally cannot reduce the clearance to zero. (In fact, even zero is too close. The usual practice is to require the clearance never to become less than the Fresnel zone radius [15]). For GPS-Squitter, that means the system design should use an effective earth radius that is less than the standard 4/3 of true. It may have to be less than unity.

Another less serious fading mechanism is that of ducting. The refractive index gradient frequently exhibits a kink in its otherwise smooth monotonic variation with height. This tends to trap the signal energy, causing the level to be enhanced at some receiver locations and attenuated at others. The changes become temporal as the weather changes and the aircraft moves. To combat this kind of fading, the designer can include sufficient link margin to keep the percentage of the time the received signal level drops below the reception threshold at an acceptable minimum.

If the required link margin turns out to be too burdensome, there is one other parameter that can relieve the situation. That parameter is the path inclination. Because the refractive index profile of the atmosphere tends to be highly stratified, the propagation effects are most severe if the ray path runs parallel to the stratification. Simply arranging for the path to be inclined to the stratification can reduce the fading substantially.

The appropriate values for the three propagation parameters (effective earth radius, link margin allocated to atmospheric fading, and minimum path inclination) depend on the application and location. At the time of writing, not enough information had been collected to determine them. However, the task is relatively straightforward. So much has been published on the effect of atmospheric conditions on line-of-sight communication links that a month or so devoted to searching the literature should yield all the information needed. It is not necessary to set up a long-term measurement program.

It should be noted that a crucial element required to determine appropriate values for the propagation parameters is the set of system requirements, and in particular, the overall system reliability. These are yet to be established. The goal, therefore, of the search of the propagation literature would be to generate a set of design curves showing the way the link reliability depends numerically on the propagation parameters. These design curves would then be incorporated in the trade off studies required to produce the final system design.

A5.0 CONCLUSIONS

The data collected during the two days devoted to exploring propagation phenomena were consistent with the simple propagation model. No anomalous propagation was seen on either day, either during the day or at sunrise.

But we cannot conclude from this evidence alone that anomalous propagation is never a problem. The reasons are that a) for propagation analysis, our data were crude, b) for this statistically varying situation, our sample was small, and c) throughout the two days, the weather was benign.

However, the long term experience of Houston Center is that the only significant anomalous propagation effect seen on the beacon radars is an occasional over-the-horizon state in which atmospheric ducting allows beacon responses to be seen from aircraft at unusually large ranges. Otherwise, the beacon radars are not vulnerable to anomalous propagation. (This

contrasts with the experience of the primary surveillance radars, for which anomalous propagation causes the clutter to move. This allows it to get past the clutter filter and mask the skin returns from the aircraft.) GPS-Squitter, which uses the same type of reply as the beacon system, transmitted by the same aircraft equipment, should be similarly invulnerable to anomalous propagation. In fact, because GPS-Squitter dispenses with the uplink interrogation of the beacon system, it should be even more immune to anomalous propagation than the beacon system.

On the other hand, years of worldwide experience with microwave relay links shows that unless these links incorporate enough ground clearance, atmospheric sub-refraction can on occasion drive the link into a deep and sustained fade. The implication of this for GPS-Squitter is that the effective earth radius used in estimating the coverage area of each ground station should be smaller than the four thirds earth radius used to account for standard atmospheric refraction. In addition, the microwave links suffer a less severe fading caused by multipath. This is handled by allocating some link margin specifically to fading and by not allowing the propagation path to be too close to the horizontal.

The bottom line is that, provided the system design parameters are chosen appropriately, anomalous propagation is not a problem for GPS-Squitter. The relevant parameters are the link margin, the path inclination and the effective earth radius. Their optimum values will depend on the climate. Tropical locations will tend to require more restrictive parameter choices than temperate ones. Although not enough information has been collected yet to allow specific numbers to be assigned to these parameters, their effect on system sizing is expected to be small.

REFERENCES

- [1] V.A. Orlando, "ADS-Mode S: Initial System Description," Project Report ATC-200, MIT Lincoln Laboratory, 2 April 1993.
- [2] V.A. Orlando, G.H. Knittel, and R.E. Boisvert, "GPS-Squitter: System Concept, Performance, and Development Program," The Lincoln Laboratory Journal, MIT Lincoln Laboratory, Vol. 7, No. 2, 1994, pp. 271-294.
- [3] R. Jones, G.H. Knittel, and V.A. Orlando, "Automatic Dependent Surveillance Broadcast via GPS-Squitter: a major upgrade to the National Airspace System," Proceedings of the SPIE International Symposium on Aerospace/Defense Sensing & Control and Dual-Use Photonics, Orlando, FL, 17-25 April 1995.
- [4] V.A. Orlando and P.R. Drouilhet, "Mode S Beacon System: Functional Description," Project Report ATC-42-D, Rev. D, MIT Lincoln Laboratory, 29 August 1986.
- [5] R.E. Boisvert, K.W. Saunders, M.L. Wood, and V.A. Orlando, "GPS-Squitter Experimental Results," Proceedings of the 13th Digital Avionics Systems Conference, IEEE/AIAA, Phoenix, AZ, October 31 - November 3, 1994, pp. 521-527.
- [6] R.E. Boisvert, K.W. Saunders, and G.H. Knittel, "Airport Surface Surveillance Using Differential GPS and the Mode S Data Link," Proceedings of the ION-94 50th Annual Meeting, Colorado Springs, CO, 6-9 June 1994, pp. 335-344.
- [7] ISO/IEC 3309: 1991 (E), "Information technology—Telecommunications and information exchange between systems—High-level data link control (HDLC) procedures—Frame structure," ISO/IEC, Fourth Edition, Geneva, Switzerland, 1991.
- [8] M.L. Meeks, Radar Propagation at Low Altitudes, Artech House, Dedham, MA, 1982, pp. 42-46.
- [9] W.H. Harman, "Effects of RF Power Deviations on BCAS Link Reliability," Project Report ATC-76, MIT Lincoln Laboratory, 7 June 1977, p. 18.
- [10] S.I. Altman and P.M. Daly, "The Enhanced Airborne Measurement Facility Recording System," Project Report ATC-228, MIT Lincoln Laboratory, 31 January 1995.
- [11] T. Logsdon, The NAVSTAR Global Positioning System, Van Nostrand Reinhold, New York, NY, 1992, p. 64.
- [12] M.L. Burrows, "GPS-Squitter Signal Propagation in the Gulf of Mexico," ATC Project Memorandum 42PM-SSS-0018, MIT Lincoln Laboratory, 5 May 1995.
- [13] H.L. Ho, J.W. Sari, and J.P. Skura, "Anomalous Propagation Through Atmospheric Ducts," Johns Hopkins APL Technical Digest, Vol. 4, No. 1, 1983.
- [14] J. Goldhirsh, G.D. Dockery, and J.H. Mayer, "Three Years of C-band Signal Measurements for Overwater, Line-of-Sight Links in the mid-Atlantic Coast: 2. Meteorological Aspects of Sustained Deep Fades," Radio Science, Vol. 29, November-December 1994, No. 6, pp. 1433-1447.
- [15] "Propagation Data and Prediction Methods Required for Terrestrial Line-of-Sight Systems," Report 338-6, Consultative Committee for International Radio, Section 5E, 1990.